

# Motorised Folding Arm Awning

## How to install your Motorised Awning

With your new Windoware Motorised Awning, you are now in full control of your outdoor space! To ensure you can enjoy your awning for years to come, please follow all of the included installation, safety and care instructions.

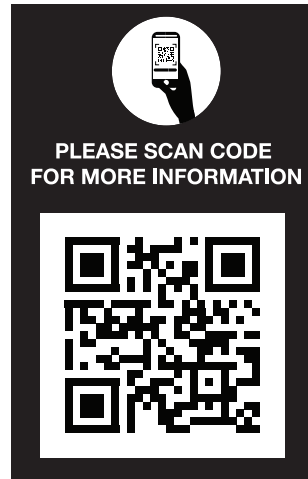
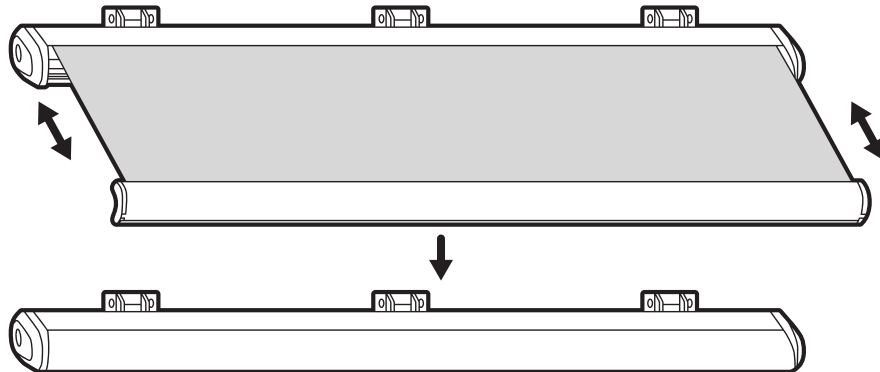

**Your pack should consist of the following components:**

### 1 x Awning Cassette

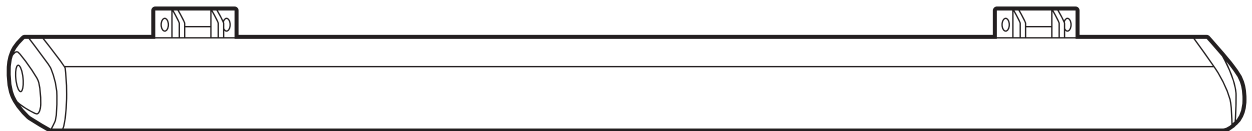

### 2 x Mounting Brackets

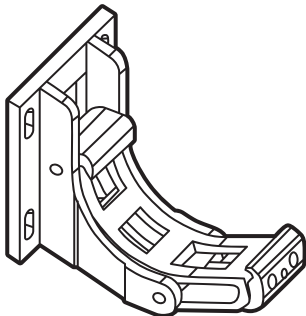

### 8 x Anchors



This awning and the included fixings are only suitable for installation on a plain cement wall or stable un-rendered brickwork. Contact a specialist if installing on other surfaces.

### 1 x Hand Crank



### 1 x Remote Control

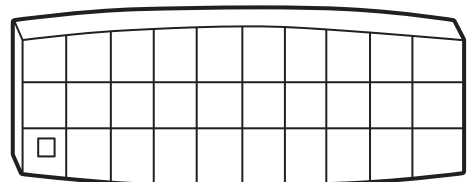

**BE AWARE OF SUDDEN EXTENSION THAT MAY OCCUR DURING UNPACKING**

### Tools needed for assembly and installation.

- Drill
- Masonry drill bit 16mm
- Level
- Wrench 14mm, 17mm and 19mm
- Step Ladder
- Tape Measure
- Chalk, Marker or Pencil
- Wooden Hammer

# Motorised Folding Arm Awning

## How to install your Motorised Awning

### 4 step Awning Installation Instructions:

A minimum of two adults are required to move and install this awning

#### 1. Measure and choose your mounting position, mark and drill fixing points

For safe and smooth installation; plan, measure and mark where you will mount your awning before you begin.

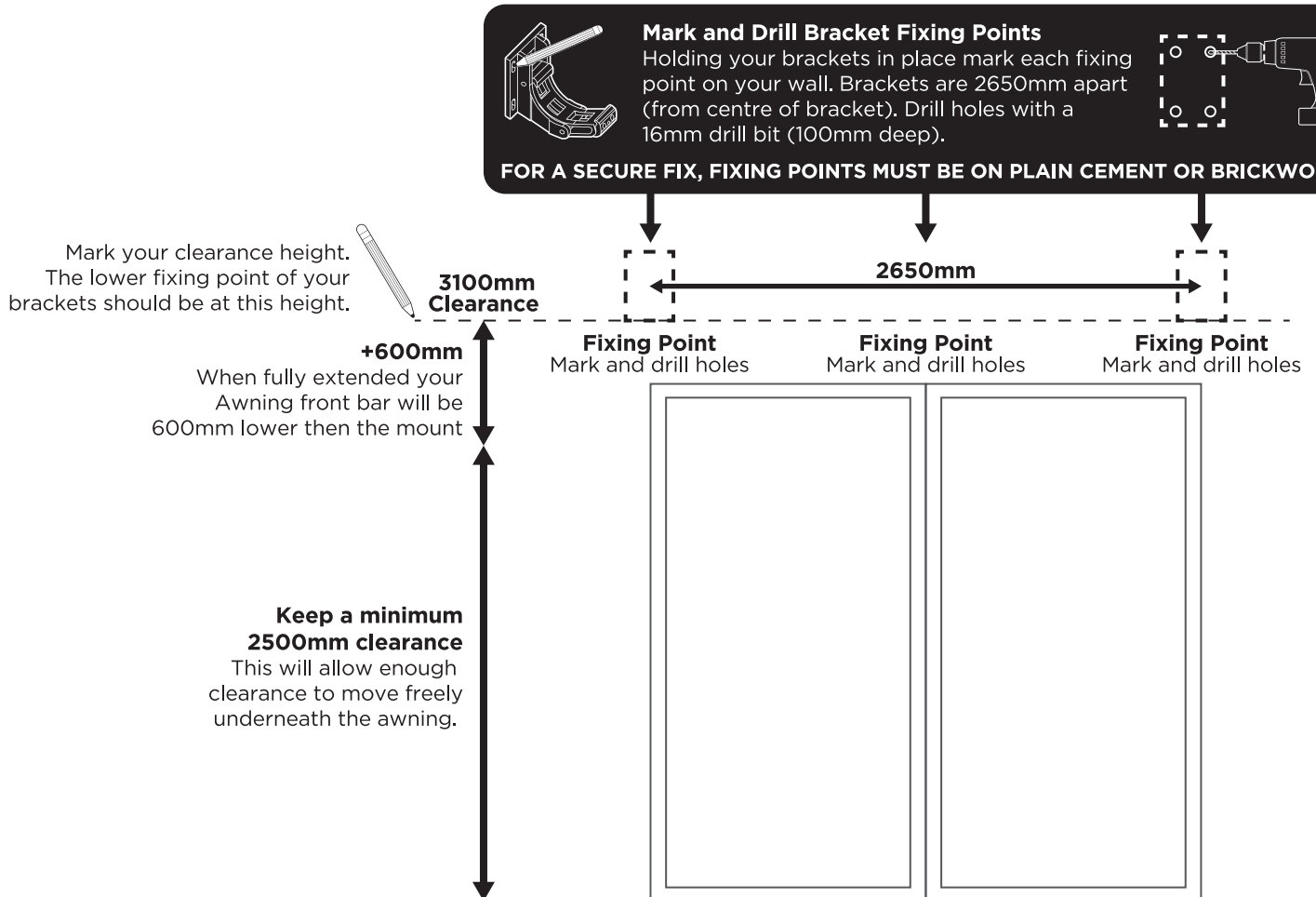

#### 2. Fixing the mounting brackets

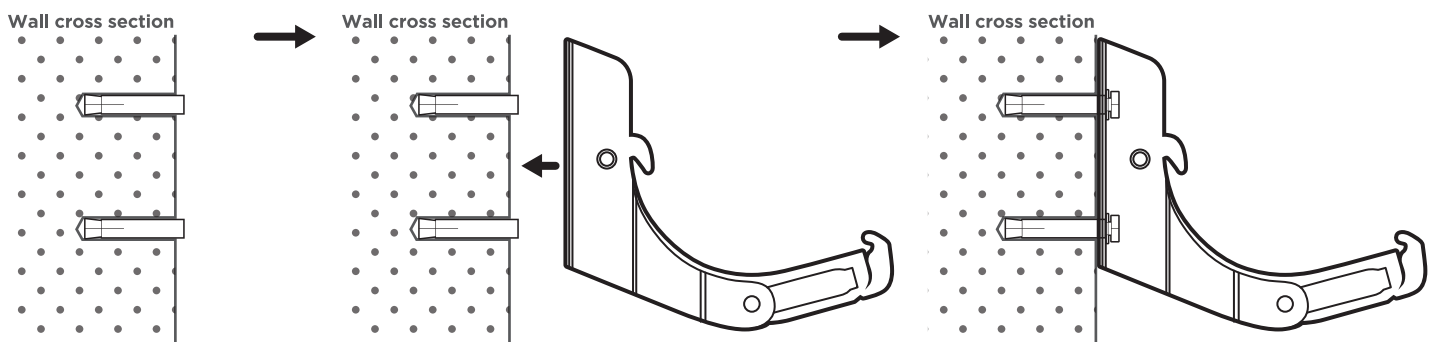

**Insert heavy duty anchors into holes.**  
 (Before inserting locknut and washers.)

**Hang brackets from protruding screws.**

**Add washers and lock nuts. Tighten well to fix brackets.**  
 Repeat this for both Brackets.



Use a 19mm wrench to firmly tighten bolts.

**Check your anchors and brackets hold securely in the wall before moving on to the next step.**

# Motorised Folding Arm Awning

## How to install your Motorised Awning

### 3. Install the awning cassette

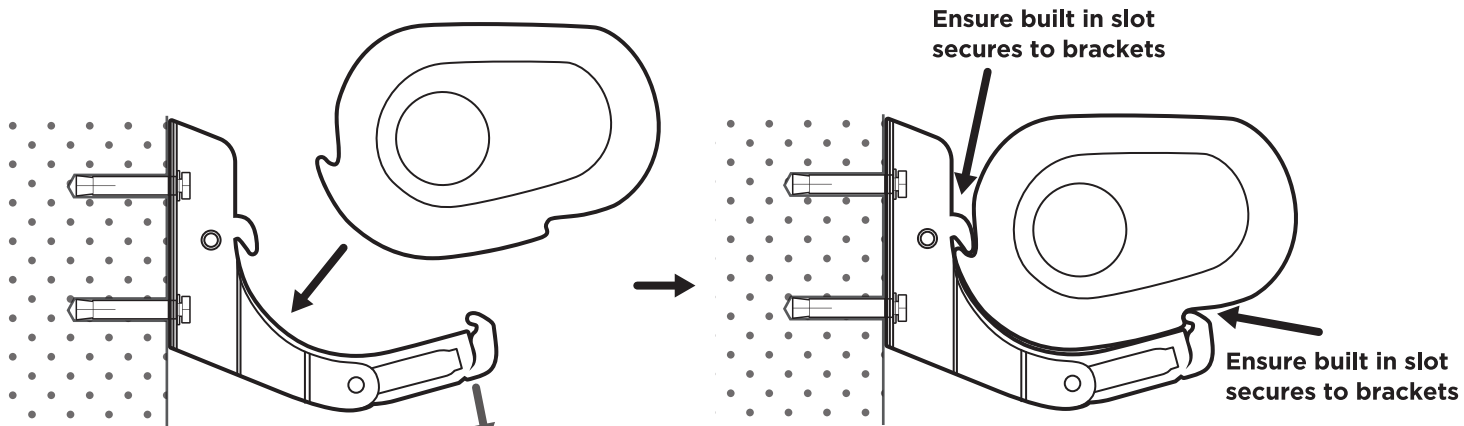

You may loosen adjuster cap bolts on the brackets to help cassette installation, ensure you tighten the bolts after awning is mounted.

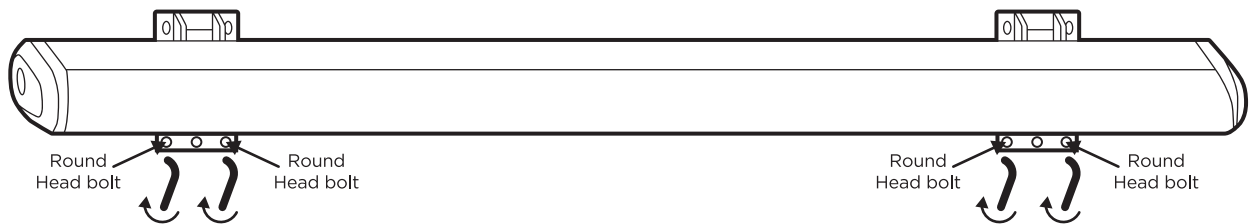
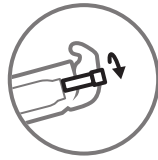

**Ensure cassette is secure to the brackets with round head bolts.  
Tighten the round head bolts firmly.**

**Incorrectly installing the awning can cause serious damage and danger. Please check all included safety instructions. Consult a professional for help.**

### 4. Install the crank ring

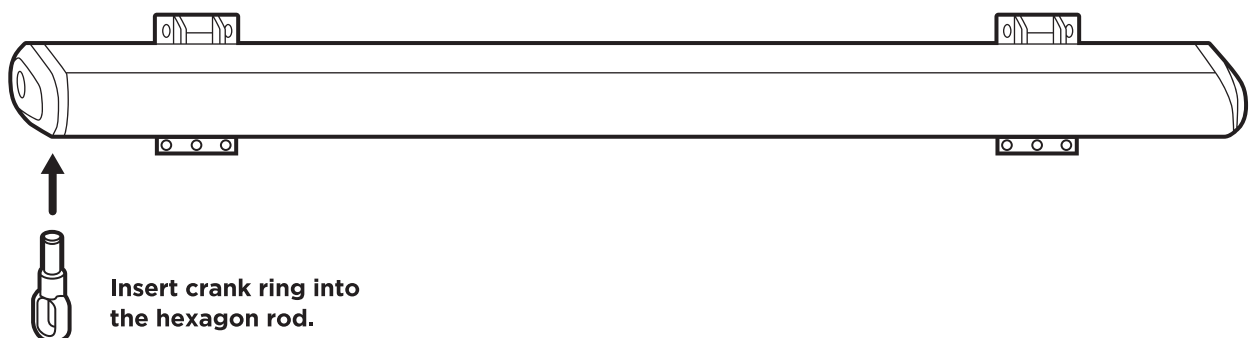

# Motorised Folding Arm Awning

## How to use your Motorised Awning

### Usage instructions

#### How to adjust your tilt angle

Your awning should be set to the optimum projection angle. However you can adjust the angle within a range of 10° to 40°. Do NOT set your angle below 14° and do NOT adjust angle whilst awning is fully extended (keep awning no more than 1/4 extended).

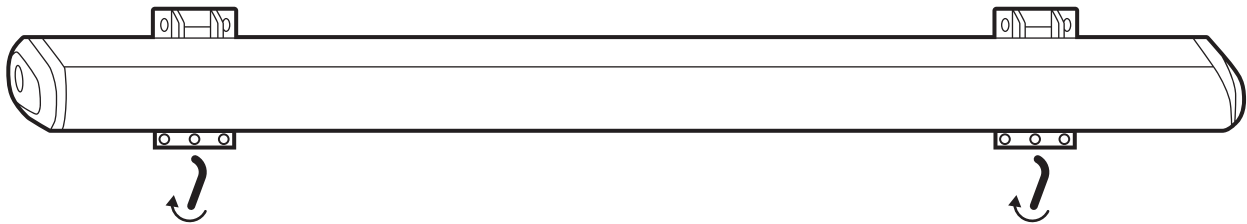
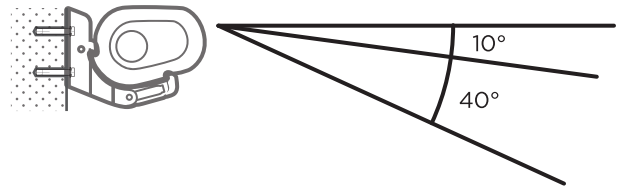

#### Use a hex key in the middle adjustment screw of each bracket to adjust angle

Do NOT force key further than end positions, this can cause damage to your awning. Keep all angles of brackets the same.

#### How to extend and retract your awning

Keep all objects or parts of your body clear of awning whilst operating. Only operate the awning when it is clearly visible.

##### 1. Connect your awning to power

If power is cut you can open/close awning using the included crank.

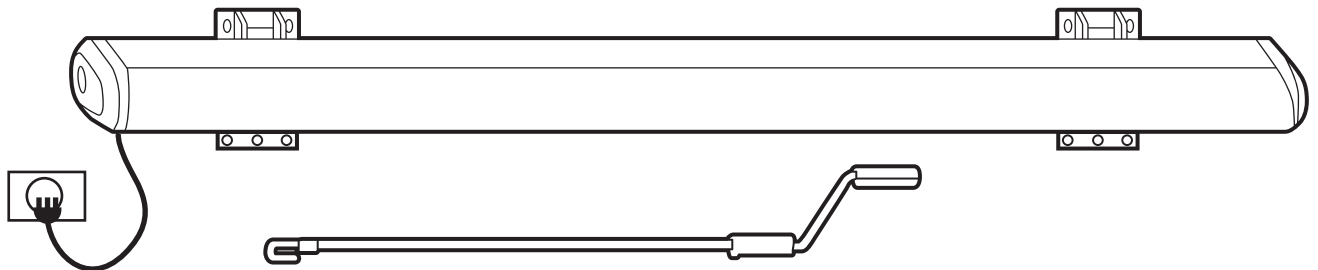

##### 2. Use your remote to operate your awning

Only operate your awning when you can clearly see it to avoid improper operation causing damage.

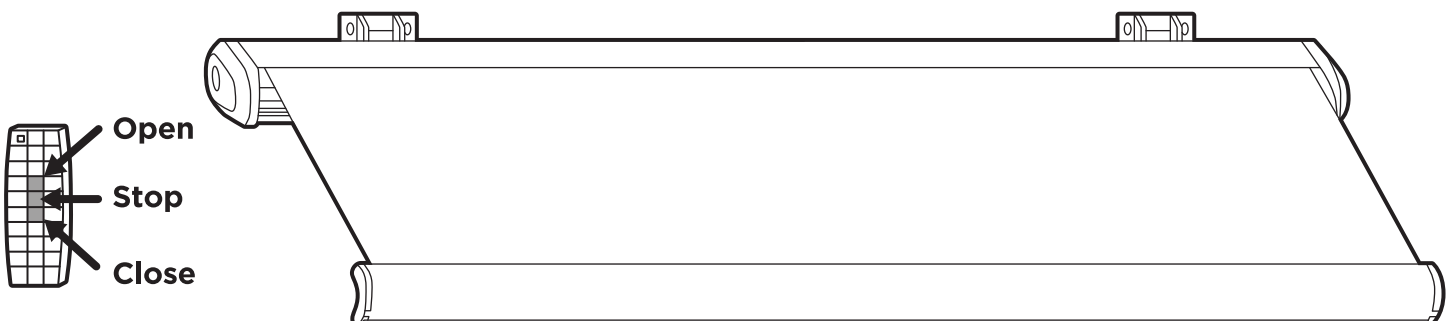

### RETRACT AWNING IN STRONG WINDS

This awning is intended for protection against sun only. Do not use/extend in strong winds, rain, hail or snow.

# Motorised Folding Arm Awning

## How to use your Motorised Awning

### How to adjust the awning projection distance limits

Your awning should come with a green hex key for this adjustment.

#### Adjust the Retraction or the “in limit”.

Using a hex key adjust the white control as per the diagram below. Turning towards + will retract the blind into the cassette. This will set your in limit.

#### Adjust the Projection or the “out limit”.

Using a hex key adjust the red control as per the diagram below. Turning towards “+” will increase the projection away from the cassette, and turning to the “-” will reduce the projection. This will set your out limit.

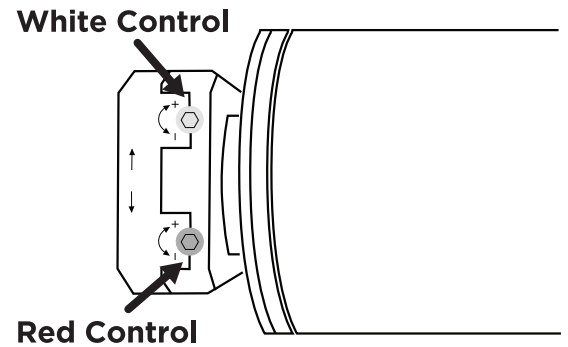

## Important Safety Instructions

### FOR YOUR OWN SAFETY AND THE SAFETY OF OTHERS IT IS IMPORTANT TO FOLLOW ALL INCLUDED INSTRUCTIONS AND OBEY ALL WARNINGS.

#### To Install this awning technical knowledge is necessary.

Do not mount this awning yourself and contact a professional if:

- You are unsure if the awning can be mounted at your chosen installation position.
- You do not understand the instruction manual or any parts of it.
- You do not have the necessary tools available.
- You do not have the technical knowledge.

#### A minimum of two healthy adults are required to move and install this awning

As this awning is large and heavy, do not try to install it alone. If the awning falls it could cause serious injuries or damage.

#### Do not install the awning if you find damaged parts or are missing any parts.

#### Keep all children and pets away from the working area during assembly and adjustments of the awning.

#### This awning and the included fixings are only suitable for installation on a plain cement wall or stable un-rendered brickwork.

If the wall shows cracks, has an exterior shell (insulation, double brick, brick facing) or is not of this material consult with a professional.

#### No changes are allowed to the products design and structure without the permission of the manufacturer.

#### Please make sure that your hands are clean prior to installation to not mark the awing fabric or frame.

#### Operation in High Wind may damage the awning.

This awning is intended for protection from the sun only.

#### Operation in frost may damage the awning.

This awning is intended for protection from the sun only.

#### Operation in snow may damage the awning.

This awning is intended for protection from the sun only.

#### Operation in rain/hail may damage the awning.

This awning is intended for protection from the sun only.

#### Do not climb onto or hang anything from the awning.

#### Exposure to these weather condition or extra weight may damage the awning or may be transferred to the structure and wall through the mounting brackets. Under extreme loads, excessive force may be exerted on the anchor bolts.

Before starting assembly check the load-bearing capacity of the mounting base if necessary, take preventative measures to ensure stable installation of the brackets. If the mounting base is unstable consult a professional

#### Remove all safety belts and protective sheeting included before operating the awning.

# Motorised Folding Arm Awning

## How to use your Motorised Awning

### Maintenance and cleaning

**Regular maintenance will not only help to keep a long durability but is also important for your own safety and the safety of other people.**

Check the brackets and wall anchors regularly, ensuring they remain tight and secure.

Check the motor is running normally, if you find any problems stop using the awning.

Examine all bolts and nuts at least once every 6 months, fasten if necessary.

Stop using the awning immediately if it has been damaged or is not fitted properly.

### Cleaning your awning.

#### Frame:

Over time, dust and dirt will collect on the frame and will require periodic cleaning to maintain its appearance.

A mild spray cleaner or water/detergent mixture may be applied to the frame to clean it. Wipe dust off with a damp cloth. Do not use aggressive detergents.

#### Fabric:

Clean the fabric every six months.

Only use natural soap, never use chemical detergents. Water should be cold to lukewarm. Let the fabric dry completely. Do not use heating appliances (e.g. hairdryer) for drying.

### Dismounting your awning.

**A minimum of two healthy adults are required to move and dismount this awning**

Retract the awning completely before you begin with dismounting.

Bind the arms of the awning together to avoid unintended unfolding. This might cause damage and injury. You can use the protection band that was fixed on the awning when purchasing it.

Follow the mounting instructions in reversed order to dismount the awning.

Make sure that drilling holes in the wall will be sealed.

Make sure that the fabric is dry completely before storing. Storing a wet fabric can cause spots and damage. Store the awning at a dry and safe place that is not reachable for children.

