

### HARDWARE SUPPLIED

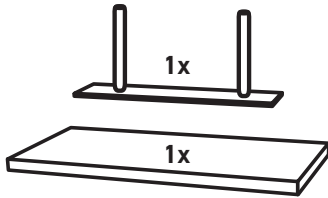

#### A MASONRY WALL INSTALLATION

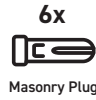

#### B PLASTERBOARD WALL INSTALLATION

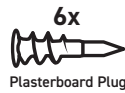

### TOOLS REQUIRED

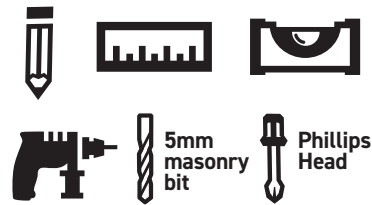

### CAPACITY



\*LOAD EVENLY DISTRIBUTED

## flexi™ TIP

### READ THROUGH INSTRUCTIONS BEFORE COMMENCING INSTALLATION

Screws and fixings for both masonry and stud walls are included.

### STEP 1

Please read through Fixing Requirements prior to commencing Installation Steps. Position bracket at desired height. Using a pencil, mark the position of 6 or more holes as required (one or more of these holes must be on the stud if mounting to plasterboard).

**Note:**

- Make sure the arrow on the bracket points up.
- Use spirit level to ensure bracket is level. (See Diagram 1)

DIAGRAM 1

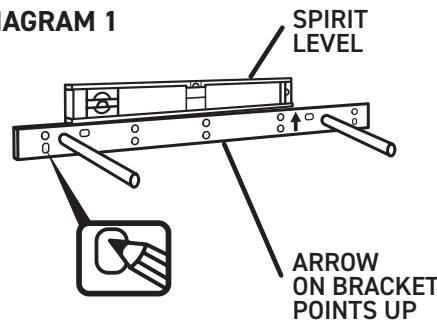

### STEP 2

**A (Masonry)** Using a 5mm masonry drill bit. Drill a 40mm deep hole. Tap Wall Plug into hole (a light hammer may be required) until flush with wall surface. Position Bracket over installed Masonry Plug and install Masonry Plug Screw into wall plug.

**B (Plasterboard)** Using a Phillips head screwdriver, use force to thread plug through Plasterboard Wall until it is flush with the surface of the wall. Position Bracket over installed Plasterboard Plug and install Plasterboard Plug Screw into wall plug.

**Note:** Refer to Fixing Requirements for additional installation information.

When installing into timber walls or directly into studs, you can install without the need for Plasterboard or Masonry plugs. We suggest pre-drilling a small hole first for easier fixing.

DIAGRAM 2

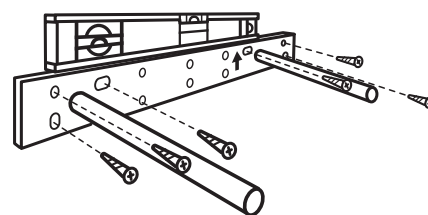

DIAGRAM 3A

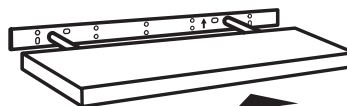
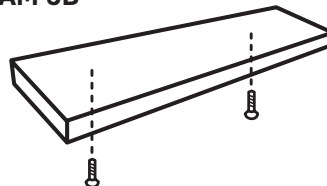

DIAGRAM 3B



### STEP 3

Slide the shelf onto the 2 tubes on the bracket.

**Note:**

- The 2 holes on the shelf face are to point down. (See Diagram 3A)
- Fix the shelf to the bracket by fitting the 2 countersunk head screws from underneath.
- Don't over-tighten (See Diagram 3B)

### FIXING REQUIREMENTS:

1. When mounting onto a Plasterboard wall mountings must be into at least 1 stud. If holes do not align with stud, an extra hole should be drilled through the bracket to accommodate this.
2. A minimum of 6 screw must be used. Try to use only one (upper or lower) of the twin holes as securing using at both of twin holes can weaken plaster.

#### NOTE:

For safety, the bracket pipes are angled slightly upward to prevent shelf droop when shelf is loaded to capacity. Please note that Floating Shelves are designed for displaying infrequently used decorative items only. Please keep gloss shelves from direct sunlight as UV light can cause discolouration.

### HOW TO USE A PLASTERBOARD PLUG:

1. Place Plasterboard Plug on the end of a screwdriver.

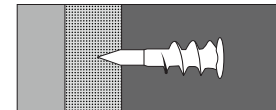

2. Lightly pierce plasterboard where the anchor is to be installed using point of Plasterboard Plug. Use firm pressure and screw Plasterboard Plug into the plasterboard until the flat head is tight and flush against the plasterboard.

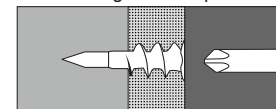

3. Attach item to be fixed to the wall by driving the Plasterboard Plug Screw into the Plasterboard Plug.

