

**HOLMAN**

# RAISED GARDEN BED

## MODULAR PLANTER KIT



PRODUCT CODE

**RGB1263R**

[www.holmanindustries.com.au](http://www.holmanindustries.com.au)

**User Guide**

# Installation

## Package Contents

1. 14× 600mm x 150mm side panels
2. 6× 300mm corner posts
3. 12× Corner post caps
4. 2× Twista™ spray on spike
5. 1× 12mm snap-on adaptor
6. 1× 12mm faucet adaptor
7. 1× 4mm barbed tee
8. 2m × 4mm poly tube

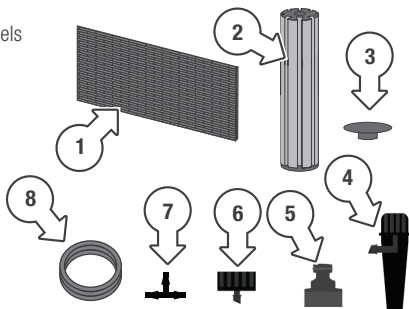

## Set up

Location is important when growing plants in your **Raised Garden Bed**. Depending on the type of plants and the amount of sun light exposure required, choose a full or part sun location for your **Garden Bed**

1. Slot two panels [a] into the corner posts [b] with the tongue facing up and rattan texture on the outside
2. Slot two panels [c] between the centre posts [d] to stabilise the **Garden Bed**

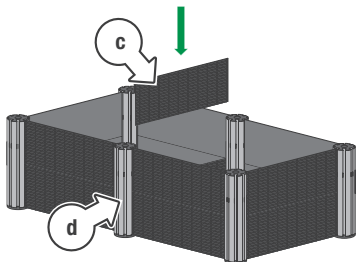
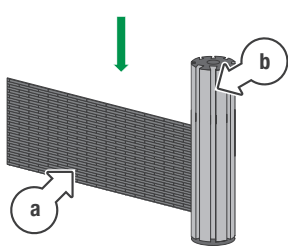

## Set up (continued)

3. Screw the post caps [e] on top of the pillars [f]

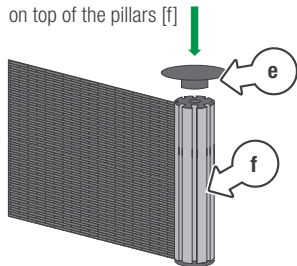

4. When all panels are assembled, place a weedmat into the **Garden Bed**, with the edges going up the side of the wall panels

- i** This is useful when planting on a solid surface, like bricks
5. Fill the **Garden Bed** with potting mix and plant your herbs, flowers or vegetables

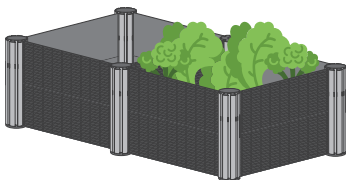

- i** To expand your garden bed with unlimited options, simply slide additional panels into the corner posts

## Irrigation

1. Screw the snap-on adaptor to the 12mm faucet adaptor [a]
2. Attach 4mm poly tube to the end of the faucet adaptor [b], cut a length of poly to reach the second **Garden Bed**
3. Attached one end of the 4mm barbed tee [c] to the poly tube
4. Attach the poly to an end of the tee [d] and cut enough to reach the middle of the first **Garden Bed**
5. Attach to one Twista™ spray on spike [e]
6. Run the remaining piece of poly

from the third end of the tee [f] to the middle of the second **Garden Bed**

7. Attach the last free end of poly to the second Twista™ spray on spike [g]
8. Connect the snap-on adaptor to your garden hose

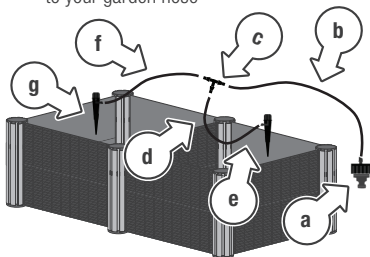



**Thanks for being a  
#SMARTGARDENER**

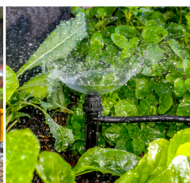
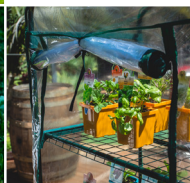

**We really appreciate having you as a customer, and  
would like to say thank you for choosing us.**

We recommend registering your new product on our website. This will ensure we have a copy of your purchase and activate an extended warranty. Keep up to date with relevant product information and special offers available through our newsletter.

[www.holmanindustries.com.au/product-registration/](http://www.holmanindustries.com.au/product-registration/)



# HOLMAN

For the #SMARTGARDENER   

Copyright © 2021 Holman Industries