



MIMOSA®

Cordoba Charcoal 2 Seater Lounge  
Installation Guide



# Cordoba Charcoal 2 Seater Lounge

**POWDER COATED ALUMINIUM FRAME**

**Polyester Padded Cushions - Grey**

**ITEM NO. : 0583689**

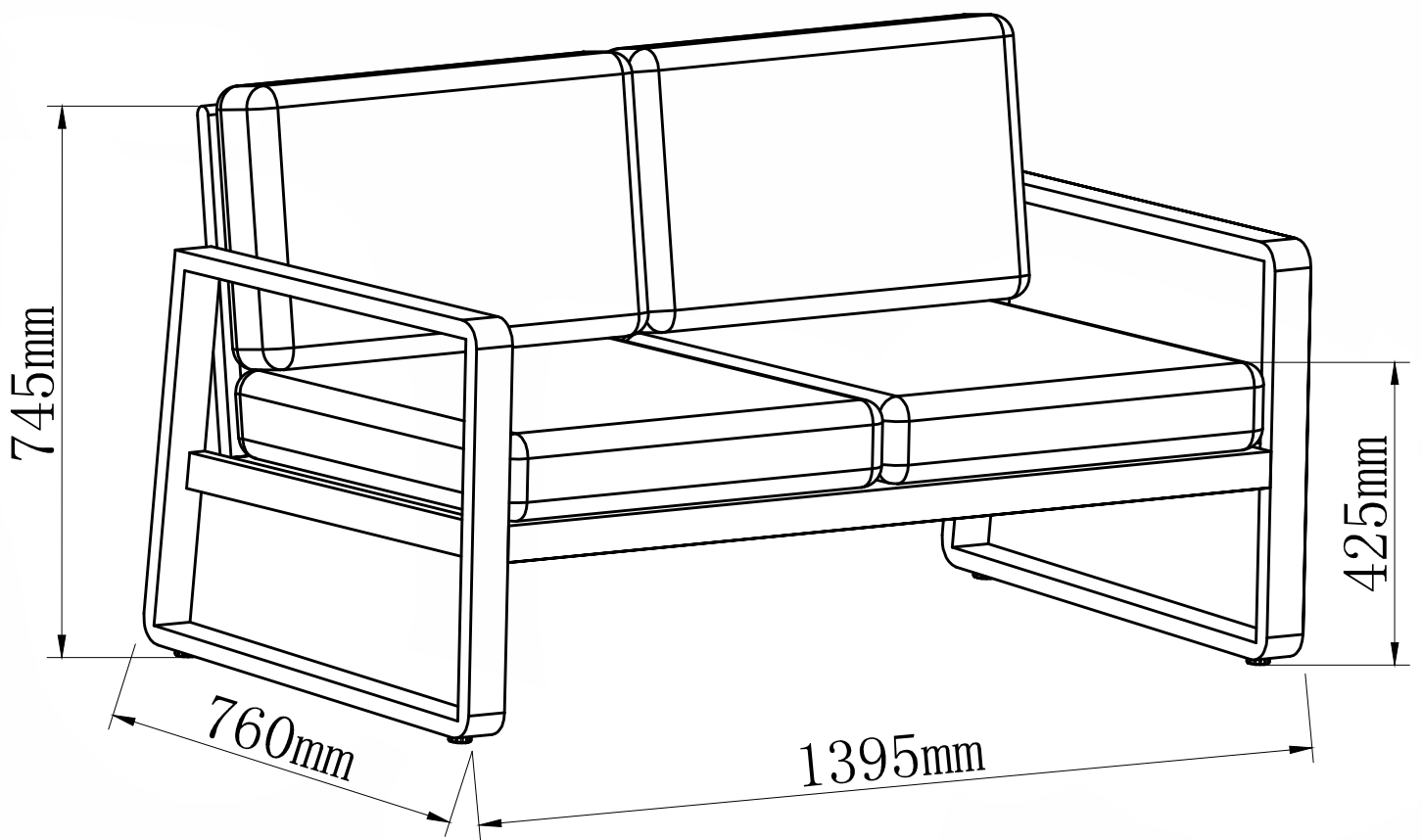



**Please carefully read the below warnings and instructions.  
Save the instructions for future reference.**





- Please carefully read all instructions before assembly and use.
- Please separate and identify all parts, ensuring that you have all parts listed.
- Assembly to be carried out by a competent adult.
- During assembly children should be kept away from the product due to possible risk of injury, small parts, and sharp fittings.
- Do NOT use power tools to assemble the product.
- Don't tight all the bolts before the product is fully assembled. Be careful not to over tighten the nuts during assembly.
- Please check the fixings are all tight monthly.

**Recommendation**



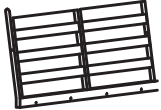
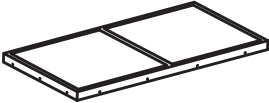
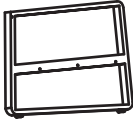



- It would be useful to ask someone to help you assemble the product.
- Retain these instructions for future reference.
- This product is not suitable for extreme weather conditions. Do NOT use in extreme weather condition such as thunderstorm, hailstone, heavy rain, high wind or heavy snow, etc. Warranty claims due to weather events won't be taken into account.
- This piece of furniture has been produced under the best possible conditions and care. However we advise you during constructing or breaking down of this piece of furniture to be aware of sharp metal.
- This product is designed for occasional use only. Do not use as a permanent structure. If no use for long time, dismantle and store safely to prevent any damage occurring.
- You must take into account that fabric may be discolored under the exposure of sunshine. This change is a natural cause, and it is not a factor for claim. It is recommended to replace the fabric every 1 or 2 years.
- To extend the life of your cushion, product should be stored in a dry and ventilated place when not in use and especially over the winter months or during rainy condition. If this is not possible, we advise you to always use a protective waterproof cover when not using the furniture.
- The maximum weight / load of this product is 240kg.
- Wipe clean with damp cloth only using detergent & lukewarm water.

6.

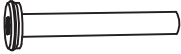
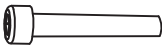

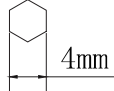
**Parts List:**

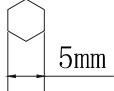
<b>Part No.</b>	<b>Pictures</b>	<b>Description</b>	<b>QTY</b>
A		Back frame	1
B		Seat frame	1
C		Left Armrest	1
D		Right Armrest	1
E		Back Cushion	2
F		Seat Cushion	2

**Hardware Kit:**

<b>Part No.</b>	<b>Pictures</b>	<b>Description</b>	<b>QTY</b>
G		Bolt M6 x 42 mm	10
H		Bolt M6 x 35 mm	2
J		Washer ø16x6.5x2 mm	10
K	 	Allen key A	1
L	 	Allen key B	1
M		Cap	10

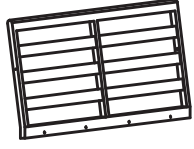
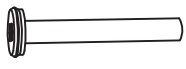
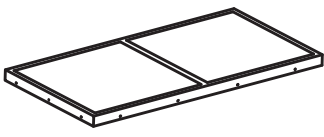
8.





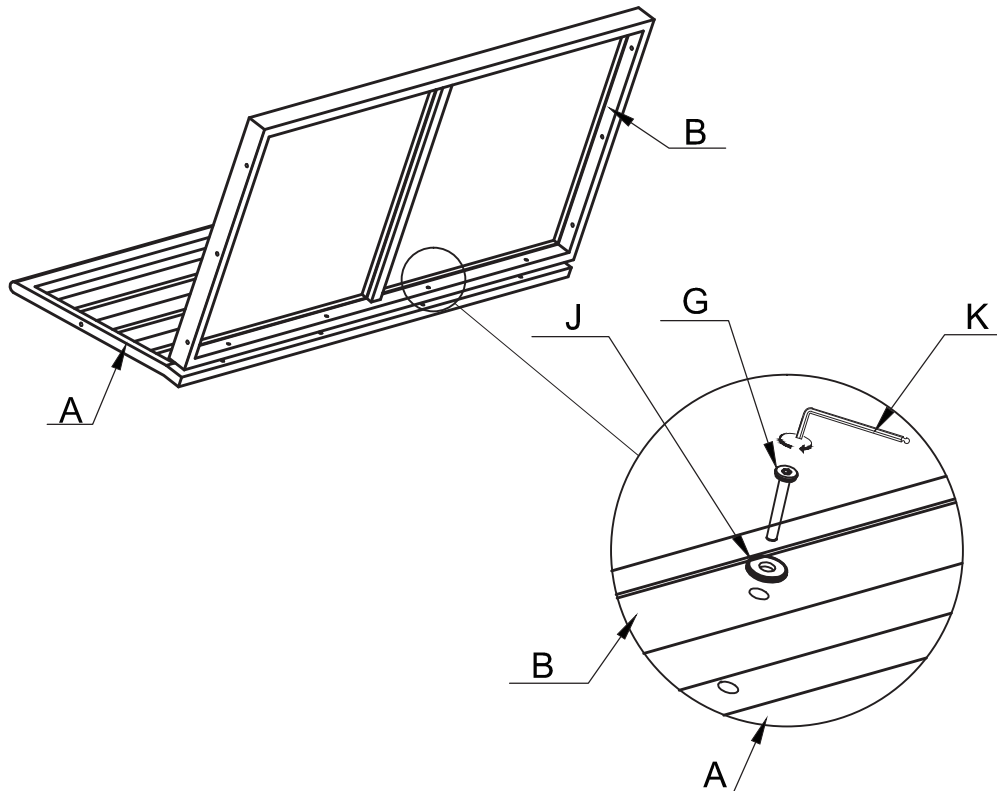

A		x1	G		x4
B		x1	J		x4

**Step 1:**

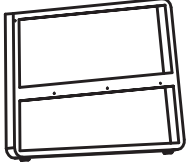
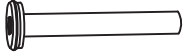
Fix the seat frame (B) to the back frame (A) with bolts (G) and washers (J).  
Once all bolts are in position tighten securely using Allen Key (K).

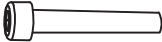
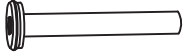

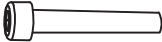
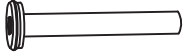

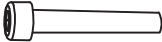
<p>C</p>  <p>x1</p>	<table><tr><td>G</td><td></td><td>x3</td></tr><tr><td>J</td><td></td><td>x3</td></tr><tr><td>H</td><td></td><td>x1</td></tr></table>	G		x3	J		x3	H		x1
G		x3								
J		x3								
H		x1								

**Step 2:**





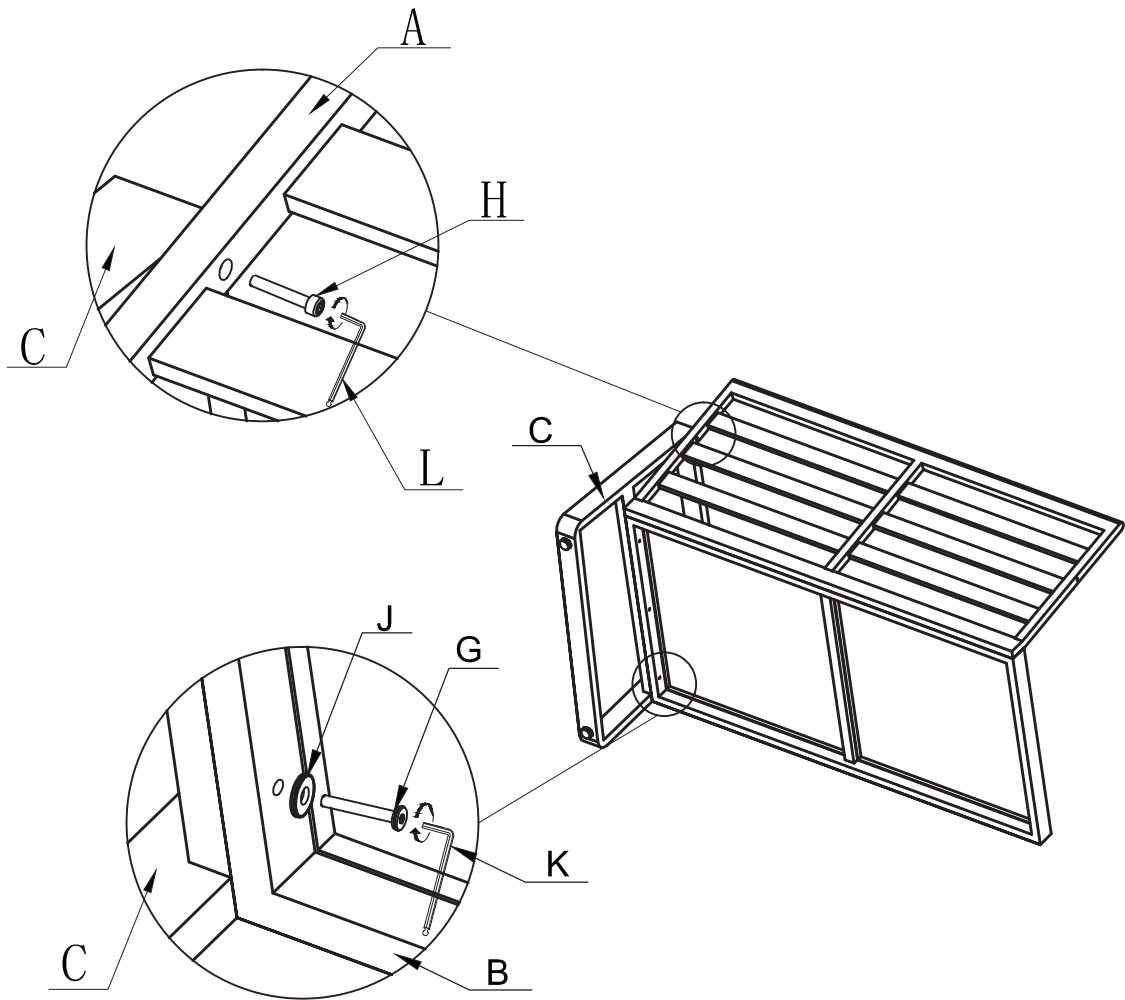

Fix the seat frame (B) to left armrest (C) with bolts (G) and washers (J).

Fix the back frame (A) to left armrest (C) with bolt (H).

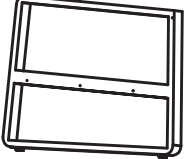
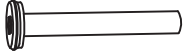
Once all bolts are in position, tighten securely bolts (G) using Allen Key (K), tighten securely bolt (H) using Allen Key (L).

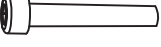
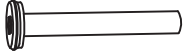

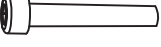
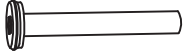
10.

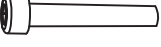
<p>D</p>  <p>x1</p>	<table><tr><td>G</td><td></td><td>x3</td></tr><tr><td>J</td><td></td><td>x3</td></tr><tr><td>H</td><td></td><td>x1</td></tr></table>	G		x3	J		x3	H		x1
G		x3								
J		x3								
H		x1								

**Step 3:**

Fix the seat frame (B) to right armrest (D) with bolts (G) and washers (J).

Fix the back frame (A) to right armrest (D) with bolt (H).

Once all bolts are in position, tighten securely bolts (G) using Allen Key (K), tighten securely bolt (H) using Allen Key (L).

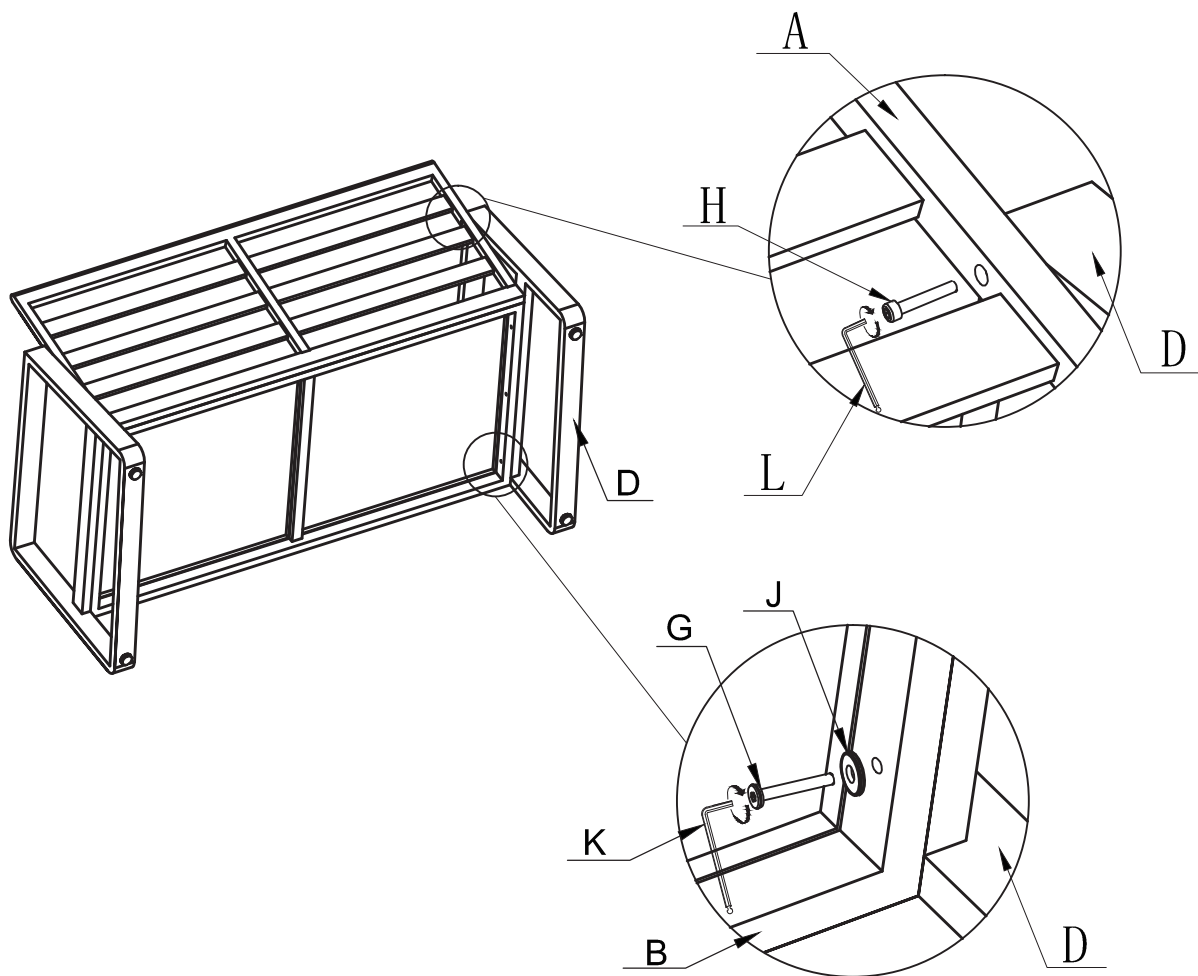

M



x 10

**Step 4:**

Cover the bolts (G) and bolts (H) with caps (M).

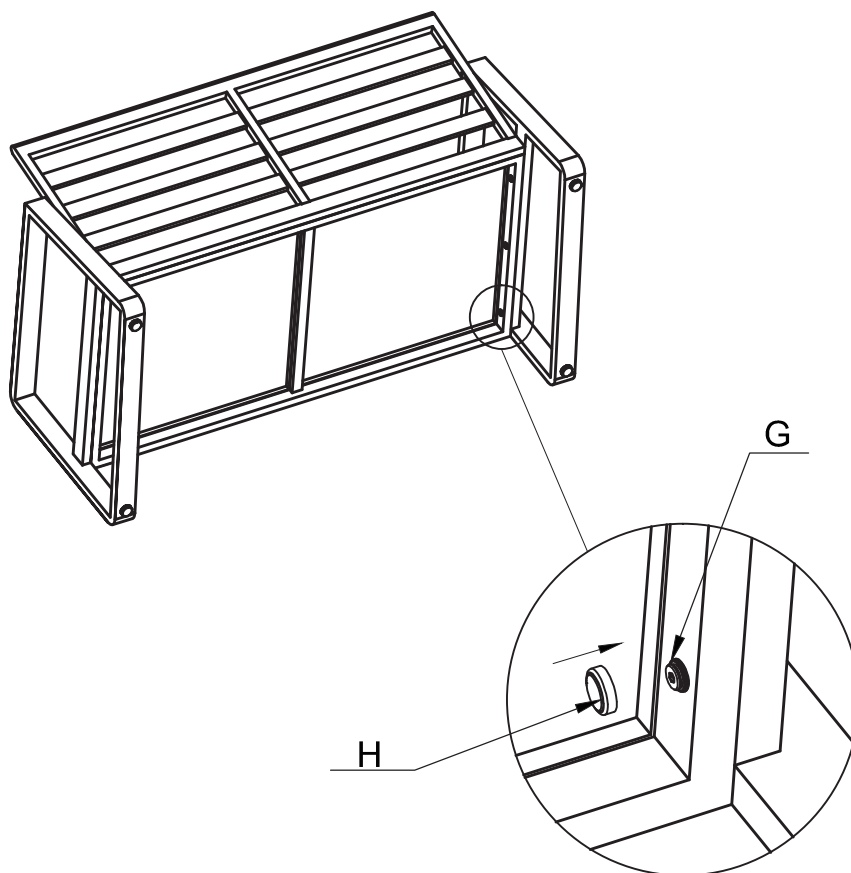

12.

E



x2

F



x2

**Step 5:**

Put the seat cushions (F) and back cushions (E) on the lounge.

