

⚠ WARNING No representation or warranty is given that your particular application of these products complies with relevant building codes. Consult with professionals and local building officials before beginning work: (i) to ensure compliance with relevant building codes for your application; (ii) to identify appropriate safety gear used during installation; (iii) to ensure that the work area is free from utilities, services and hazards; and (iv) to clarify any instructions or warnings that may not be clear. Work in a safe manner wearing protective gear such as gloves, eyewear, headwear, footwear and clothing. When using tools comply with operation manuals and instructions. Inspect and maintain these products on a regular basis.

Neither Peak Products Pty Limited nor Peak Products Corporation shall be liable for any loss or damage resulting from the improper installation or improper use of this product, subject to any contrary provision of the Australian Consumer Law in Australia or the Consumer Guarantees Act in New Zealand. Peak products and associated materials are protected by patents, designs, copyrights and/or trademarks.

Component List

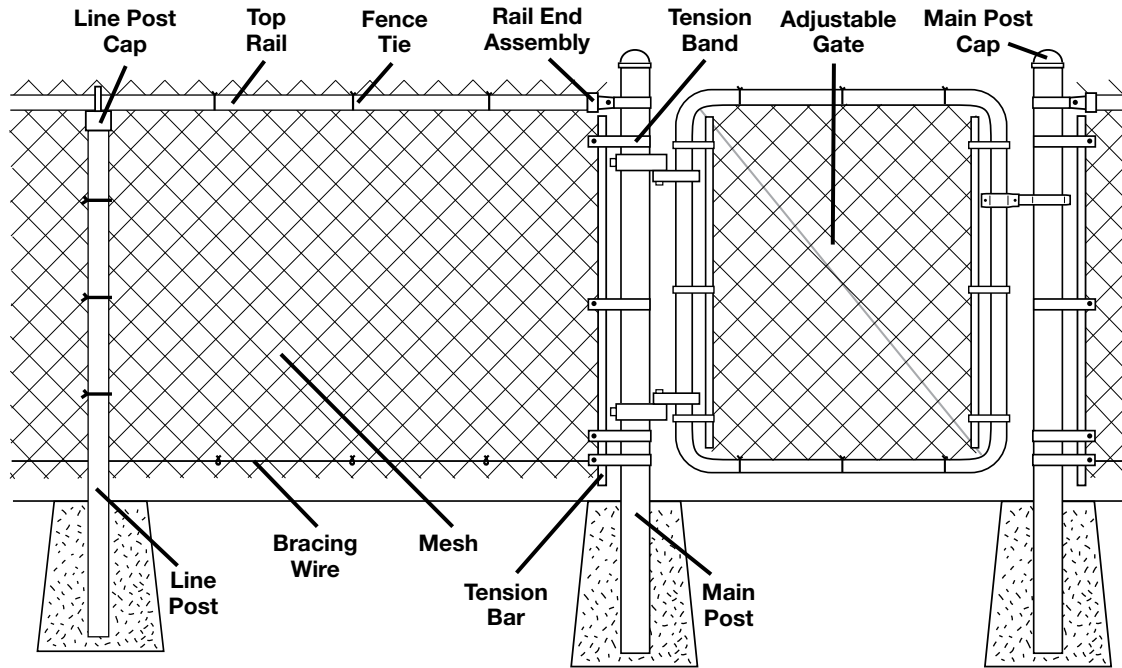

Tools and Materials Needed

- 40 x 40 x 600 mm timber stakes
- Hammer
- Heavy string, 2.5 times the total length of fence
- Spray paint (for marking post hole locations)
- Post-hole digger
- Concrete - approx. 2 x 20 kg bags per post
- Wheelbarrow and shovel to mix concrete
- Adjustable spanner
- Metal cutting saw for cutting top rails
- Heavy-duty pliers with wire cutter (fencing pliers)
- Fence stretcher
- Hand puller or hand winch

Planning

Prior to starting your fencing project, check with your local authorities for:

- location of underground services / utilities
- location of legally established property lines
- obtaining building codes and permits

1 Install String Lines & Mark Locations of Posts

Using timber stakes (or similar) and string, install string lines to determine the exterior face of your new fence. Ensure that you stay within legally established property lines.

Using spray paint, mark the position of all main posts and line posts. Main posts should be used at all corners, ends and beside gates. Space line posts equally between main posts (line post spacing should not exceed 3 m).

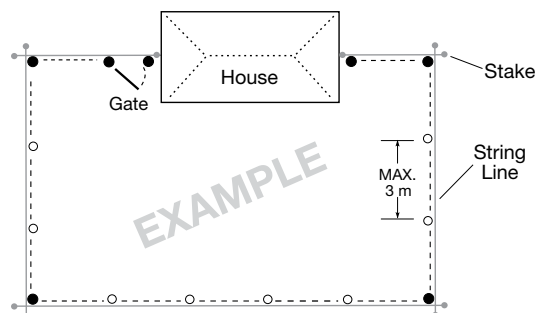

2 Dig Post Holes & Set Posts

Dig Post Holes

Using a post hole digger or auger, dig holes for posts.

Recommended main post depth underground: 550 mm

Recommended line post depth underground: 650 mm

Tops of post holes should be approx. 200 mm diameter for main post & approx. 150 mm diameter for line posts.

Install Main Posts

Mix concrete, place main posts into centre of post holes (just touching string line), surround bases of posts with concrete* and ensure posts are plumb. Finished height of main posts should be 50 mm higher than the height of the fencing mesh you are using. (For uneven or terraced ground, posts may need to be set higher.)

Install Line Posts

After main post concrete has set, install a string line between main posts 100 mm from the top. Mix concrete, place line posts into centre of post holes (just touching both front and top string lines), surround base of posts with concrete* and ensure posts are plumb. Finished height of line posts should be 100 mm lower than main posts.

(For uneven or terraced ground, posts may need to be set higher.)

*To help prevent premature corrosion of post, trowel top of concrete to slope away from post.

Install post caps onto main posts.

Once line post concrete has set, remove string lines.



CHECK BEFORE YOU DIG!

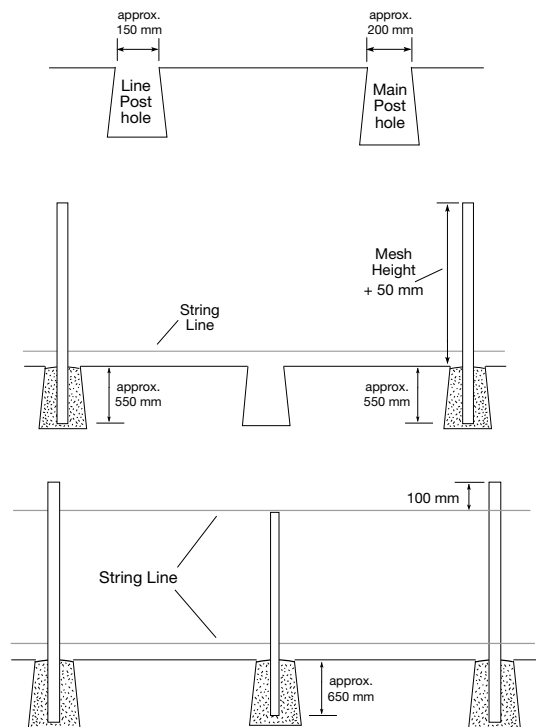

3 Install Top Rails & Bracing Wire

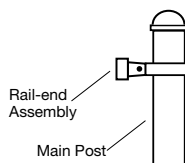

Install rail-end assembly at first post.

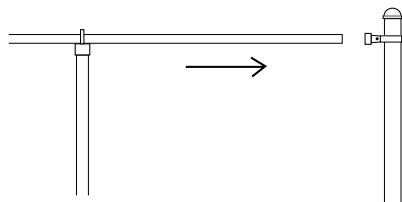

Install line post caps onto line posts, feed top rail through caps and insert top rail into rail-end assembly at first main post.

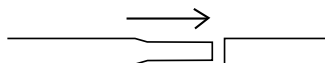

Continue to feed additional top rails through line post caps. Connect rails by inserting tapered end of rail into next rail.

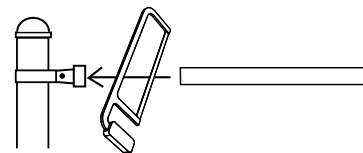

Cut final top rail to length with metal cutting saw and attach top rail to main post with rail-end assembly.

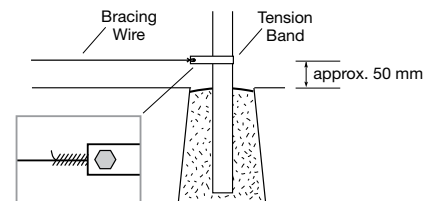

Install tension band approx. 50 mm from bottom of post. Offset (flat) section of tension band should run along the same side of the fence as the fencing mesh. Wrap bracing wire around bolt in tension band and twist bracing wire on itself to secure.

4 Install Fencing Mesh

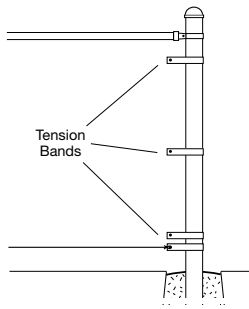

Install tension bands on main posts to accept tension bar and fencing mesh (3 bands per post). Offset (flat) section of tension band should run along the same side of the fence as the mesh.

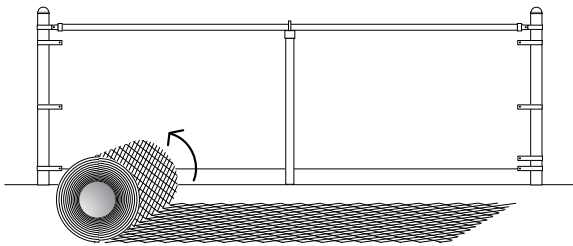

Starting at a main post, unroll mesh on the ground towards next main post.

To remove excess mesh, use pliers to open top & bottom 'knuckles' (where wires are locked together) and unweave one of the wires.

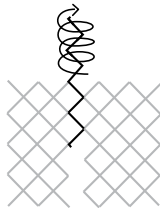

To attach additional mesh, weave a wire through two separate sections and using pliers, lock 'knuckles' together.

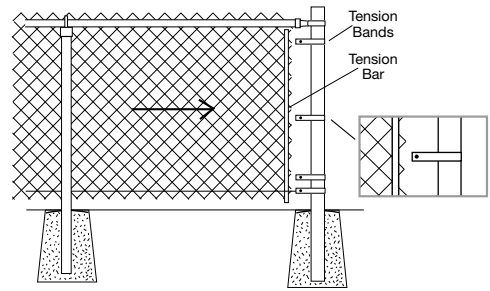
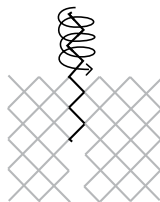

Lean mesh against posts and top rail.

Insert a tension bar through one end of the mesh and attach to first main post using tension bands.

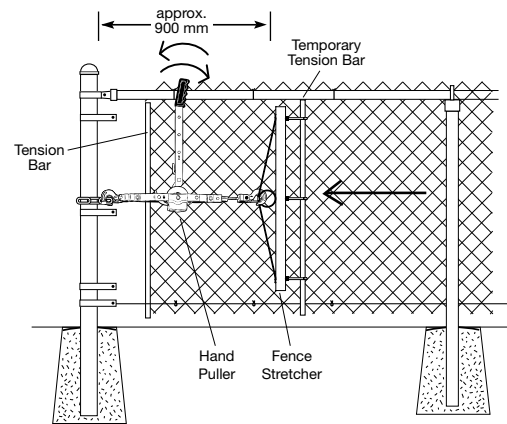

Install a temporary tension bar approx. 900 mm from final main post. Using a Fence Stretcher and Hand Puller (or Hand Winch), stretch mesh towards final main post and attach mesh to final main post with another tension bar and tension bands.

Do not over-stretch the mesh - it should have a slight amount of movement when squeezed by hand. Once securely installed, release fence stretcher and remove temporary tension bar.

5 Attach Fence Mesh to Line Posts, Top Rail and Bracing Wire

Using fence ties, attach fencing mesh to top rail, line posts and bracing wire using the following spacing:

- Top rail: every 600 mm
- Line post: every 300 mm
- Bracing wire: every 600 mm

