

ozito

LINE TRIMMER

500W 290mm

INSTRUCTION MANUAL

SPECIFICATIONS

Power:	500W
No Load Speed:	9,300/min
Cutting Diameter:	290mm
Line Diameter:	1.5mm
Line Feed:	Automatic
Weight:	2.8kg

ozito.com.au

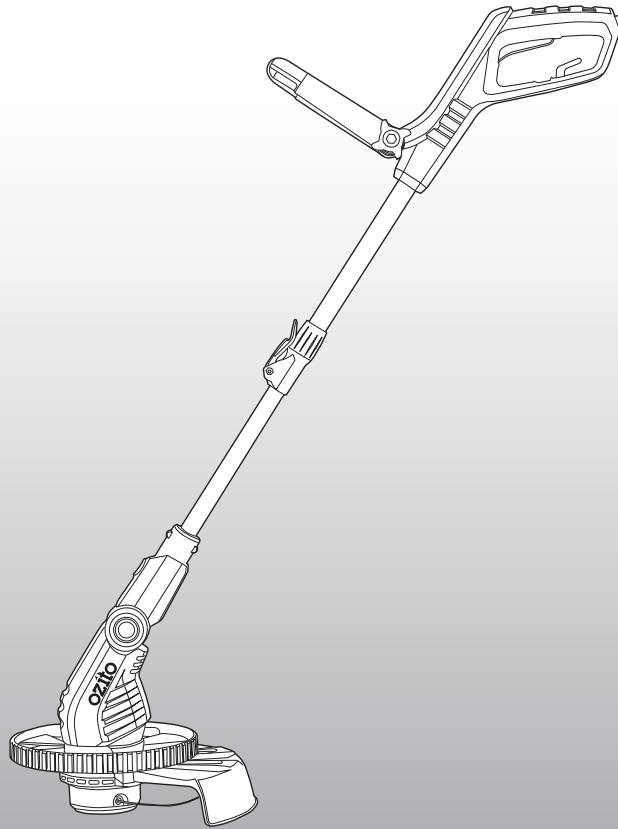

WHAT'S IN THE BOX

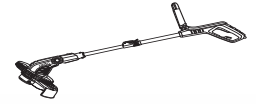

Line Trimmer

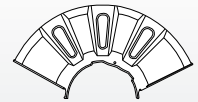

Safety Guard



Adjustable Handle & Locking Knob

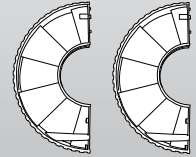

Edging Wheel

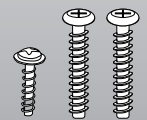

Assembly Fasteners

3 YEAR REPLACEMENT WARRANTY

LTR-529

WARRANTY

IN ORDER TO MAKE A CLAIM UNDER THIS WARRANTY YOU MUST RETURN THE PRODUCT TO YOUR NEAREST BUNNINGS WAREHOUSE WITH YOUR BUNNINGS REGISTER RECEIPT. PRIOR TO RETURNING YOUR PRODUCT FOR WARRANTY PLEASE TELEPHONE OUR CUSTOMER SERVICE HELPLINE:

Australia 1800 069 486

New Zealand 0508 069 486

TO ENSURE A SPEEDY RESPONSE PLEASE HAVE THE MODEL NUMBER AND DATE OF PURCHASE AVAILABLE. A CUSTOMER SERVICE REPRESENTATIVE WILL TAKE YOUR CALL AND ANSWER ANY QUESTIONS YOU MAY HAVE RELATING TO THE WARRANTY POLICY OR PROCEDURE.

The benefits provided under this warranty are in addition to other rights and remedies which are available to you at law.

Our goods come with guarantees that cannot be excluded at law. You are entitled to a replacement or refund for a major failure and for compensation for any other reasonably foreseeable loss or damage. You are also entitled to have the goods repaired or replaced if the goods fail to be of acceptable quality and the failure does not amount to a major failure.

Generally you will be responsible for all costs associated with a claim under this warranty, however, where you have suffered any additional direct loss as a result of a defective product you may be able to claim such expenses by contacting our customer service helpline above.

3 YEAR REPLACEMENT WARRANTY

Your product is guaranteed for a period of **36 months from the original date of purchase** and is intended for DIY (Do It Yourself) use only. If a product is defective it will be replaced in accordance with the terms of this warranty. Warranty excludes consumable parts, for example: carbon brushes, line etc.

WARNING

The following actions will result in the warranty being void.

- If the tool has been operated on a supply voltage other than that specified on the tool.
- If the tool shows signs of damage or defects caused by or resulting from abuse, accidents or alterations.
- Failure to perform maintenance as set out within the instruction manual.
- If the tool is disassembled or tampered with in any way.
- Professional, industrial or high frequency use.

KNOW YOUR PRODUCT

LINE TRIMMER

- | | |
|------------------------------|----------------------------|
| 1. Rotating Head Lock Button | 7. Safety Guard |
| 2. Telescopic Shaft | 8. Cutter Head |
| 3. Telescopic Shaft Lever | 9. Edging Wheel |
| 4. Adjustable Handle | 10. Head Angle Lock Button |
| 5. Main Handle | 11. Locking Knob |
| 6. On/Off Trigger | 12. Cord Retainer |

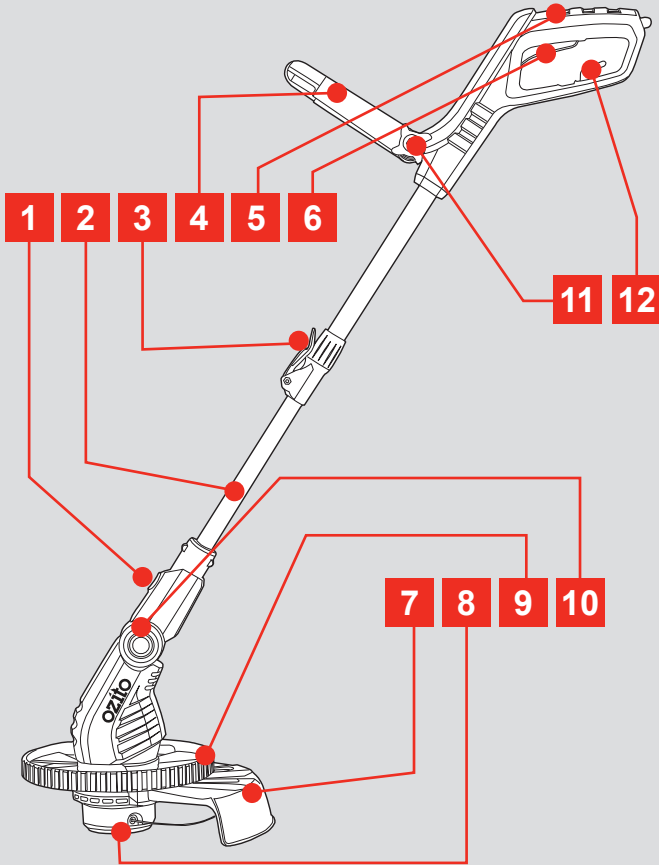

ACCESSORIES:

- 13. Edging Wheel Assembly Screws x2
- 14. Guard Assembly Screw x1

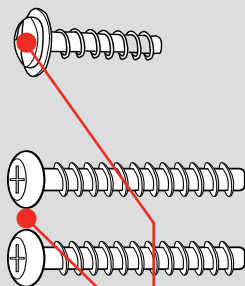

13 14

ONLINE MANUAL

Scan this QR Code with your mobile device to take you to the online manual.



SETUP & PREPARATION

1. ASSEMBLY



WARNING! ENSURE THE TOOL IS DISCONNECTED FROM THE POWER SUPPLY BEFORE PERFORMING ANY OF THE FOLLOWING OPERATIONS.

Fitting the Safety Guard

1. Turn the trimmer upside down and slide the Safety Guard into the recess in the line trimmer housing.

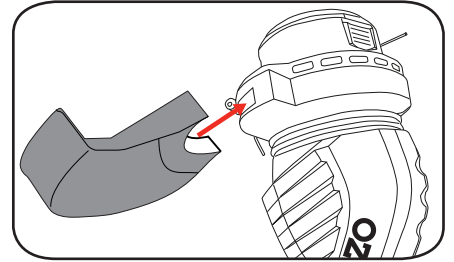

2. Secure in place with supplied Guard Assembly Screw.

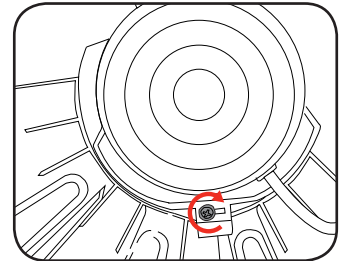

WARNING! NEVER USE THE LINE TRIMMER UNLESS THE SAFETY GUARD IS PROPERLY FITTED AND SECURED.

Fitting the Edging Wheel

1. Align both halves of the Edging Wheel with the recess around the line trimmer housing.

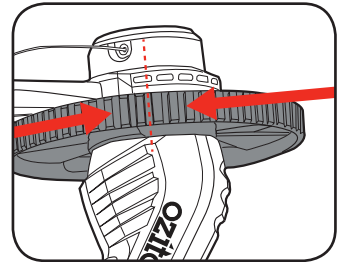

2. Secure in place with the 2 supplied Edging Wheel Assembly Screws.

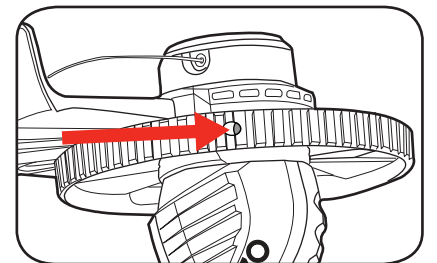

3. Once secure, check that the Edging Wheel is free to rotate. If not, refit the Edging Wheel and Safety Guard ensuring they are in the correct orientation.

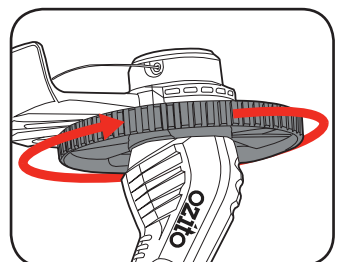

3 YEAR REPLACEMENT WARRANTY

Fitting the Adjustable Handle

1. Place the Adjustable Handle between the bracket so it is positioned correctly.

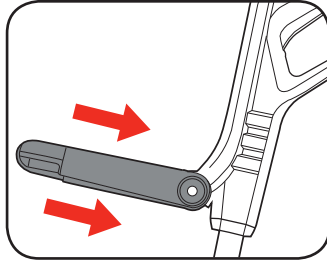

2. Insert the supplied Locking Knob and secure with the locking nut. Do not overtighten.

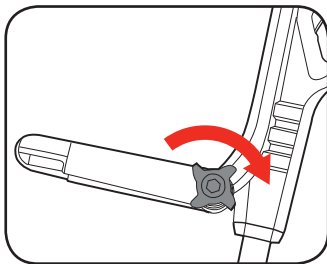

2. ADJUSTMENTS

Adjusting the Cutter Head Angle

1. Depress the Head Angle Lock Button to allow the head to tilt.

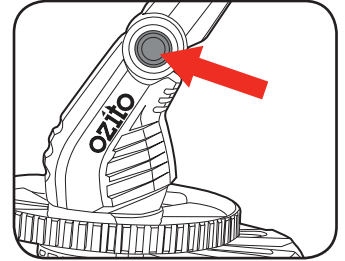

2. Move the Telescopic Shaft into the required position and release the Head Angle Lock Button.

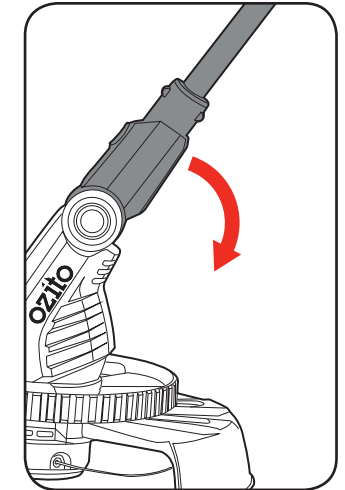

Note: Ensure the cutter head angle is locked into place before operating.

Rotating the Cutting Head

The line trimmer is fitted with a rotating head to allow for edging and trimming. To switch between the two, the head must be rotated following the steps below.

1. Press the Rotating Head Lock Button up to allow the head to rotate.

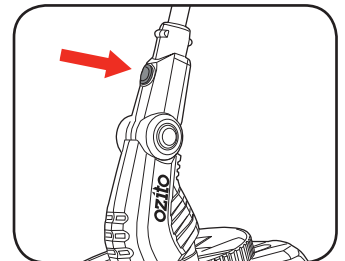

2. Rotate the head 90° anti-clockwise and release the button to lock in place.

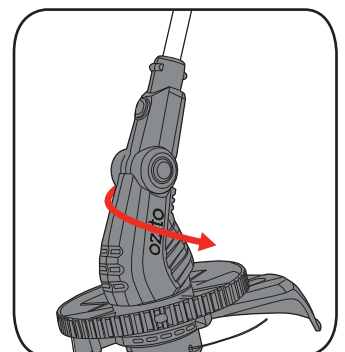

Note: The head will only rotate in one direction.

Adjusting the Working Height

1. Release the Telescopic Shaft Lever.
2. Adjust the Telescopic Shaft up or down to the appropriate height.
3. Tighten the Telescopic Shaft Lever once adjustment is complete.

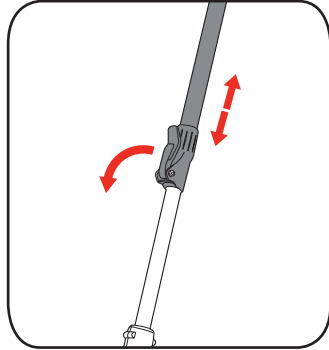

3. CORD RETAINER

Using the Cord Retainer

1. Make a loop with the extension cord and push it through the hole under the on/off trigger.
2. Place the loop onto the cord retainer and ensure it is pulled firmly into place.

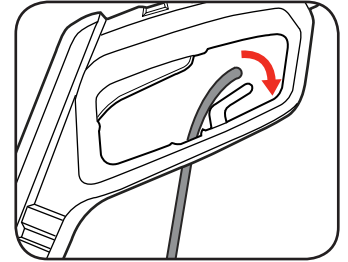
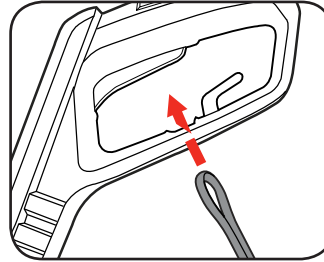

3. Connect the extension cord socket to the line trimmer cord.

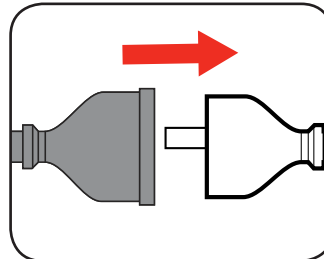

CAUTION: TO AVOID THE EXTENSION CORD FROM DETACHING; ALWAYS CHECK THAT THE CORD IS ATTACHED TO THE CORD RETAINER BEFORE USE.

OPERATION

4. CONTROLS

CAUTION: TO REDUCE THE RISK OF ELECTRICAL SHOCK, A RESIDUAL CURRENT DEVICE (RATED 30mA OR LESS) SHOULD BE USED.

On/Off Trigger

1. To switch ON, depress the On/Off trigger.

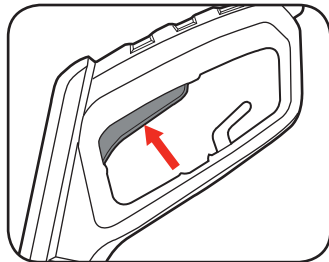

2. To switch OFF, release the On/Off trigger.

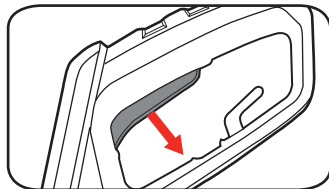

WARNING! THE LINE TRIMMER MAY RUN FOR A FEW SECONDS AFTER IT HAS BEEN SWITCHED OFF. LET THE MOTOR COME TO A COMPLETE STANDSTILL BEFORE SITTING THE TOOL DOWN.

Automatic Line Feed

This line trimmer is equipped with Automatic Line Advancement which automatically feeds the additional line to the correct length as it wears down.

- To automatically advance the line, allow the line trimmer to come to a complete stop. When the head comes to a stop, a "Click" can be heard. The line will have automatically advanced approximately 5cm. If a longer length of line is required, repeat the automatic line advancement instruction.

Manual Line Feed

- To manually advance the line, ensure the line trimmer is off and turn the line trimmer upside down. Push the tab on the side of the cutter head and then pull on the end of both pieces of line protruding from the cutter head.

5. USING THE TRIMMER

CAUTION: DO NOT CONTINUALLY TAP, BUMP OR HOLD THE SPOOL HOLDER ON THE GROUND AS THIS MAY RESULT IN DAMAGE TO THE SPOOL HOLDER OR OVERLOAD THE UNIT.

1. Wear eye protection and stout shoes at all times while operating the line trimmer.
2. Start cutting nearest the mains power source and work away to make it easier to avoid the extension cord.

3. Do not push the line against hard material (rocks or concrete) during cutting as this may result in damaged line.

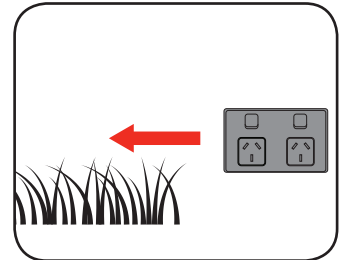

4. Never use the line trimmer without its safety devices.
5. Do not cut grass that is wet (The best results are achieved on dry grass).
6. Wait until the line trimmer reaches full speed before cutting the grass
7. Keep the line trimmer away from hard objects in order to avoid unnecessary wear to the line.

8. Several passes will be required to cut long grass as shown.

9. To prevent the line from breaking ensure you approach the edge/object slowly.

10. Watch out for kickbacks in the event of impact with hard objects.

11. After finishing the cutting operation, keep the head close to ground level, release the switch and allow the motor to come to a complete standstill. Unplug and place the line trimmer on the ground.

12. Keep ventilation slots of the trimmer clean at all times. Periodically clean out the grass from the cutting head and the rim of the safety guard to ensure efficient operation at all times.

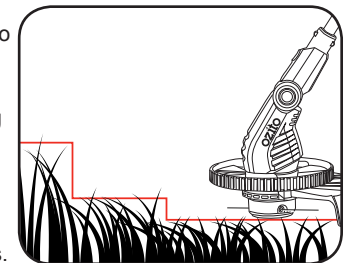

WARNING! MAKE SURE THAT THE WORK AREA IS FREE OF ROCKS, DEBRIS, LINES AND OTHER FOREIGN OBJECTS.

OPERATION

MAINTENANCE

6. TRIMMING & EDGING

Trimming

Move the line trimmer from side to side as you walk forward, holding it at an angle of approx. 30° (Light cuts are better than heavy cuts as they allow the cut grass to fall away from the cutting head).

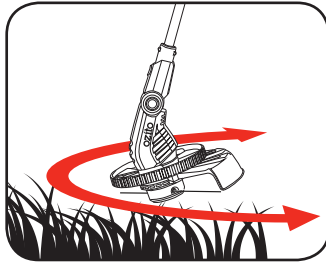

Edging

Place the edging wheel along the ground and roll the line trimmer along the edge of the path.

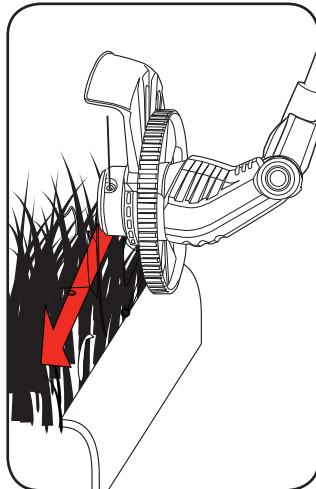

7. LINE AND SPOOL



WARNING! ENSURE THE TOOL IS DISCONNECTED FROM THE POWER SUPPLY BEFORE PERFORMING ANY OF THE FOLLOWING OPERATIONS.

Replacing the spool/clearing jams and tangled lines

From time to time, especially when cutting thick or stocky weeds, the line feeding hub may become clogged with sap or other material and the line will become jammed as a result. To clear the jam, follow these steps.

1. Press the release tabs on the line spool cover and remove the cover by pulling it straight off.

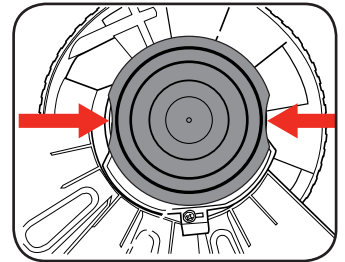

2. Lift the spool of nylon line out of the hub and clear any broken line or cutting debris from the spool area. In case of jams and tangled line, unwrap about 11cm of line to ensure that it is undamaged.

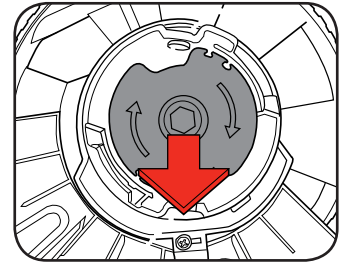

3. Insert the spool into the spool housing.

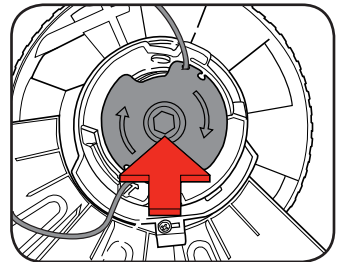

4. Unclip the ends of the cutting lines and guide them into the eyelets. The line should protrude approximately 11cm from the spool housing.

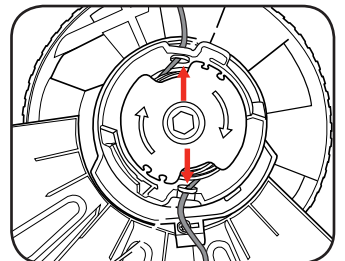





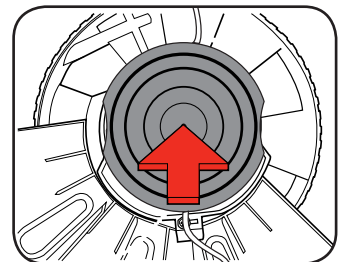





Note: If the cutting lines protrude beyond the trimming blade, cut them off so that they just reach the blade.

5. Snap the spool cover back onto the spool housing.



DESCRIPTION OF SYMBOLS

V	Volts	Hz	Hertz
~	Alternating current	W	Watts
/min	Revolutions or reciprocation per minute	n_o	No load speed
	Double insulated		Regulator compliance mark
	Warning		Read instruction manual
	Wear eye protection		Do not operate in the rain
	Disconnect the mains plug if the cord is damaged or entangled		Decibel level
	Wear hearing protection		
			Danger, flying objects Keep bystanders away

Rewinding spool from a bulk line

Bulk line for your line trimmer is available from your local dealer.

To install, follow steps:

1. Remove the spool as described in steps 1 - 2 of the “**Replacing the spool/clearing jams and tangled lines**” section.

2. Using 1.5mm or 1.6mm of line, cut a length of line approximately 8m long. Divide the line evenly so you find the half-way point and cut in half.

3. Feed approximately 15mm on one end of each line into the hole in the spool to lock it in place.

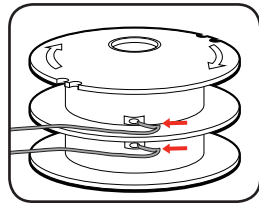

4. Wind the 2 lines onto each section of the spool in the direction of the arrow. Make sure to wind the line on neatly and in layers. Do not cross the line as this will stop it from feeding.

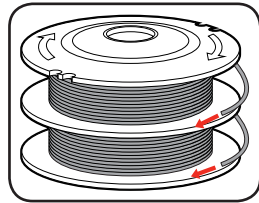

5. When the length of line is wound onto the spool place the end of the line into the clips in the outside of the spool. Leaving about 11cm protruding from the spool

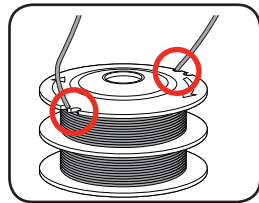

6. Re-seat the spool as described in steps 3 - 5 of the “**Replacing the spool/clearing jams and tangled lines**” section.

- Keep ventilation slots of the trimmer clean at all times. Periodically clean out the grass from the cutting head and the rim of the safety guard to ensure efficient operation at all times.
- After each use, blow air through the tool housing to ensure it is free from all dust, dirt, etc. Build up of dust, dirt particles may cause the tool to overheat and shorten the life of the tool.
- If the housing of the trimmer requires cleaning, do not use solvents but a moist soft cloth or soft brush only.
- Never let any liquid get inside the tool, never immerse any part of the tool into liquid.
- No lubrication is necessary as the tool has sealed bearings.
- When not in use, the line trimmer should be stored in a dry, frost free location not within the reach of children.

Note: Ozito Industries will not be responsible for any damage or injuries caused by the repair of the line trimmer by an unauthorised person or by mishandling of the line trimmer. This tool is designed for DIY use - use in commercial or industrial environments will void the warranty.

TROUBLESHOOTING

Problem	Cause	Remedy
Grass wraps around the attachment shaft and the trimmer head.	Cutting tall grass at ground level.	Make several passes from top down.

SPARE PARTS

Spare parts can be ordered from the Special Orders Desk at your local Bunnings Warehouse.

For further information, or any parts not listed here, visit

www.ozito.com.au or contact Ozito Customer Service:

Australia 1800 069 486

New Zealand 0508 069 486

E-mail: enquires@ozito.com.au

CARING FOR THE ENVIRONMENT



Power tools that are no longer usable should not be disposed of with household waste but in an environmentally friendly way. Please recycle where facilities exist. Check with your local council authority for recycling advice.



Recycling packaging reduces the need for landfill and raw materials. Reuse of recycled material decreases pollution in the environment. Please recycle packaging where facilities exist. Check with your local council authority for recycling advice.



ELECTRICAL SAFETY



WARNING! When using mains-powered tools, basic safety precautions, including the following, should always be followed to reduce risk of fire, electric shock, personal injury and material damage.

Read the whole manual carefully and make sure you know how to switch the tool off in an emergency, before operating the tool.

Save these instructions and other documents supplied with this tool for future reference.

The electric motor has been designed for 230V and 240V only. Always check that the power supply corresponds to the voltage on the rating plate.

Note: The supply of 230V and 240V on Ozito tools are interchangeable for Australia and New Zealand.



This tool is double insulated therefore no earth wire is required.

To reduce the risk of electrical shock, a residual current device (rated 30mA or less) must be used.

If the supply cord is damaged, it must be replaced by the manufacturer, its service agent or similarly qualified persons in order to avoid a hazard.

Note: Double insulation does not take the place of normal safety precautions when operating this tool. The insulation system is for added protection against injury resulting from a possible electrical insulation failure within the tool.

Using an Extension Lead

Always use an approved extension lead suitable for the power input of this tool. Before use, inspect the extension lead for signs of damage, wear and ageing. Replace the extension lead if damaged or defective.

When using an extension lead on a reel, always unwind the lead completely. Use of an extension lead not suitable for the power input of the tool or which is damaged or defective may result in a risk of fire and electric shock.

It is recommended that the extension lead is a maximum of 25m in length. Do Not use multiple extension leads.

Supply cords shall not be lighter than:

- if polyvinyl chloride insulated, ordinary polyvinyl chloride sheathed flexible cord (code designation 60227 IEC 53).



GENERAL POWER TOOL SAFETY WARNINGS



WARNING! Read all safety warnings and all instructions. Failure to follow the warnings and instructions may result in electric shock, fire and/or serious injury.

Save all warnings and instructions for future reference. The term "power tool" in the warnings refers to your mains-operated (corded) power tool or battery-operated (cordless) power tool.

1. Work area safety

- Keep work area clean and well lit. Cluttered or dark areas invite accidents.
- Do not operate power tools in explosive atmospheres, such as in the presence of flammable liquids, gases or dust. Power tools create sparks which may ignite the dust or fumes.
- Keep children and bystanders away while operating a power tool. Distractions can cause you to lose control.

2. Electrical safety

- Power tool plugs must match the outlet. Never modify the plug in any way. Do not use any adapter plugs with earthed (grounded) power tools. Unmodified plugs and matching outlets will reduce risk of electric shock.
- Avoid body contact with earthed or grounded surfaces, such as pipes, radiators, ranges and refrigerators. There is an increased risk of electric shock if your body is earthed or grounded.
- Do not expose power tools to rain or wet conditions. Water entering a power tool will increase the risk of electric shock.
- Do not abuse the cord. Never use the cord for carrying, pulling or unplugging the power tool. Keep cord away from heat, oil, sharp edges or moving parts. Damaged or entangled cords increase the risk of electric shock.
- When operating a power tool outdoors, use an extension cord suitable for outdoor use. Use of a cord suitable for outdoor use reduces the risk of electric shock.
- If operating a power tool in a damp location is unavoidable, use a residual current device (RCD) protected supply. Use of an RCD reduces the risk of electric shock.

3. Personal safety

- Stay alert, watch what you are doing and use common sense when operating a power tool. Do not use a power tool while you are tired or under the influence of drugs, alcohol or medication. A moment of inattention while operating power tools may result in serious personal injury.
- Use personal protective equipment. Always wear eye protection. Protective equipment such as dust mask, non-skid safety shoes, hard hat, or hearing protection used for appropriate conditions will reduce personal injuries.
- Prevent unintentional starting. Ensure the switch is in the off-position before connecting to power source and/or battery pack, picking up or carrying the tool. Carrying power tools with your finger on the switch or energising power tools that have the switch on invites accidents.

- Remove any adjusting key or wrench before turning the power tool on. A wrench or a key left attached to a rotating part of the power tool may result in personal injury.
 - Do not overreach. Keep proper footing and balance at all times. This enables better control of the power tool in unexpected situations.
 - Dress properly. Do not wear loose clothing or jewellery. Keep your hair, clothing and gloves away from moving parts. Loose clothes, jewellery or long hair can be caught in moving parts.
 - If devices are provided for the connection of dust extraction and collection facilities, ensure these are connected and properly used. Use of dust collection can reduce dust-related hazards.
- ## 4. Power tool use and care
- Do not force the power tool. Use the correct power tool for your application. The correct power tool will do the job better and safer at the rate for which it was designed.
 - Do not use the power tool if the switch does not turn it on and off. Any power tool that cannot be controlled with the switch is dangerous and must be repaired.
 - Disconnect the plug from the power source and/or the battery pack from the power tool before making any adjustments, changing accessories, or storing power tools. Such preventive safety measures reduce the risk of starting the power tool accidentally.
 - Store idle power tools out of the reach of children and do not allow persons unfamiliar with the power tool or these instructions to operate the power tool. Power tools are dangerous in the hands of untrained users.
 - Maintain power tools. Check for misalignment or binding of moving parts, breakage of parts and any other condition that may affect the power tool's operation. If damaged, have the power tool repaired before use. Many accidents are caused by poorly maintained power tools.
 - Keep cutting tools sharp and clean. Properly maintained cutting tools with sharp cutting edges are less likely to bind and are easier to control.
 - Use the power tool, accessories and tool bits etc. in accordance with these instructions, taking into account the working conditions and the work to be performed. Use of the power tool for operations different from those intended could result in a hazardous situation.
- ## 5. Service
- Have your power tool serviced by a qualified repair person using only identical replacement parts. This will ensure that the safety of the power tool is maintained.

This appliance is not intended for use by persons (including children) with reduced physical, sensory or mental capabilities, or lack of experience and knowledge, unless they have been given supervision or instruction concerning use of the appliance by a person responsible for their safety.

Young children should be supervised to ensure that they do not play with the appliance.



LINE TRIMMER SAFETY WARNINGS

EE.2 Safe operating practices

EE.2.1 Training

- Read the instructions carefully. Be familiar with the controls and the proper use of the machine.
- Never allow people unfamiliar with these instructions or children to use the machine. Local regulations can restrict the age of the operator.
- Keep in mind that the operator or user is responsible for accidents or hazards occurring to other people or their property.

EE.2.2 Preparation

- Before use, check the supply and extension cord for signs of damage or aging. If the cord becomes damaged during use, disconnect the cord from the supply immediately. DO NOT TOUCH THE CORD BEFORE DISCONNECTING THE SUPPLY. Do not use the appliance if the cord is damaged or worn.
- Never operate the machine while people, especially children, or pets are nearby.
- Wear eye protection and stout shoes at all times while operating the machine.

EE.2.3 Operation

- Keep supply and extension cords away from **cutting means**.
- Use the machine only in daylight or good artificial light.
- Never operate the machine with damaged guards or shields or without guards or shields in place.
- Switch on the motor only when the hands and feet are away from the **cutting means**.

- Always disconnect the machine from the power supply (i.e. remove the plug from the mains or remove the disabling device)
 - whenever leaving the machine unattended;
 - before clearing a blockage;
 - before checking, cleaning or working on the machine;
 - after striking a foreign object;
 - whenever the machine starts vibrating abnormally.
- Take care against injury to feet and hands from the **cutting means**.
- Always ensure that the ventilation openings are kept clear of debris.

EE.2.4 Maintenance and storage

- Disconnect the machine from the power supply (i.e. remove the plug from the mains or remove the disabling device) before carrying out maintenance or cleaning work.
- Use only the manufacturer's recommended replacement parts and accessories.
- Inspect and maintain the machine regularly. Have the machine repaired only by an authorized repairer.
- When not in use, store the machine out of the reach of children.

EE.2.5 Recommendation

- The appliance should be supplied via a residual current device (RCD) with a tripping current of not more than 30 mA.