



PRODUCT MANUAL

DOUBLE HAMMOCK KIT

TT402DK



200KG CAPACITY

HAMMOCK FABRIC SIZE: **160(W)** x **210(L)**cm

HAMMOCK STAND MAX SIZE: **330(L)** x **100(W)** x **100(H)**cm



WARNING

Read instructions before use and keep for future reference. Failure to read these instructions before use can lead to an increased risk of injury. When installing always check with a qualified builder for safety. Two Trees will only guarantee the performance of this product when used with other Two Trees products. i.e. if non Two Trees hammocks or frames are used, the guarantee is void.

Thank you for purchasing a Two Trees hammock.

We at Two Trees know the importance of spending time relaxing. Hence we've developed a range of quality hammocks and convenient accessories that come with easy to follow instructions so that you will be relaxing in no time. It is important to read all instructions before use and take care when using your hammock. Please ensure that you adhere to the following safety measures to get the maximum enjoyment from your new hammock.



WARNING

Read instructions before use and keep for future reference. Failure to read these instructions before use can lead to an increased risk of injury. When installing always check with a qualified builder for safety.

CAUTION AND SAFETY INSTRUCTIONS

1. Assembly must be carried out by an Adult.
2. Ensure hammock is fully assembled before use.
3. **DO NOT** exceed the maximum load of 200kgs.
4. **DO NOT** climb into hammock feet first.
5. **DO NOT** stand in hammock.
6. **DO NOT** dive into or jump about in hammock.
7. **DO NOT** stick your head through the suspension cords.
8. Keep suspension cords as straight as possible, **DO NOT** twist.
9. Inspect frame feet and ensure they are stable before use.
10. **DO NOT** use damaged or weakened hammock hanging accessories.
11. Hammock fabrics and accessories will wear over time and use. Always check the loading capacity and condition of parts before use.
12. Hammocks are not designed for swinging, playing, climbing or to be used as a children's toy.
13. **DO NOT** leave children or pets unattended in or near hammock.
14. Hammock fabric, suspension cords and hanging accessories will become worn over time and use. Always inspect prior to use and **DO NOT** use if items show signs of damage or weakness.
15. Always check the loading capacity before use.
16. Keep hammock clear of obstructions.
17. Allow a minimum of 50cm clearance range around the perimeter of your hammock when in use (Fig. 1).
18. Only use the hammock on level floors with shock-absorbing properties such as carpet or outdoor grass to minimise the risk of injury in case of an accident. **DO NOT** use on slippery or hard surfaces.
19. Never use a free standing brick wall to hang your hammock.
20. Only use Two Trees accessories for hanging your hammock.
21. **DO NOT** modify hammock. Hammock must be used in accordance of this manual.
22. **DO NOT** smoke in or around the hammock. Keep away from heat or flames.
23. **DO NOT** use whilst wearing shoes, clothing, jewellery or accessories that have a hook and loop fastener.
24. **DO NOT** use near sharp objects.
25. A copy of this manual must be provided should the hammock transfer ownership.

SELECTING THE LOCATION

There are many ways to hang your hammock, here are some of our favourite and recommended options:



**BETWEEN
TREES**



**BETWEEN
TWO POSTS**

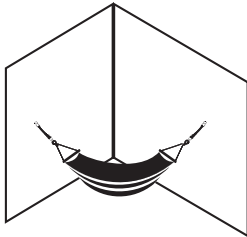

**BETWEEN
TWO WALLS**



**ON HAMMOCK
FRAME**

THE TWO TREES HAMMOCKS RANGE INCLUDES





WARNING:

Read instructions before use and keep for future reference. Failure to read these instructions before use can lead to an increased risk of injury. When installing always check with a qualified builder for safety.



DO NOT twist or knot suspension cords when hanging.

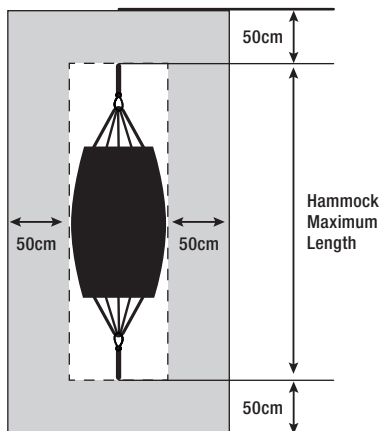

Allow a minimum of 50cm clearance range around the perimeter of your hammock when in use. <Fig.1>

You need a minimum of 3.2 metres space to fully assemble this hammock kit. At first, the included hammock will require 3 metres to get the ideal shape. However, through use of your hammock will naturally stretch and sag. This is why we've added a 20cm extension to your hammock stand, so you can adjust your hammock and continue relaxing.

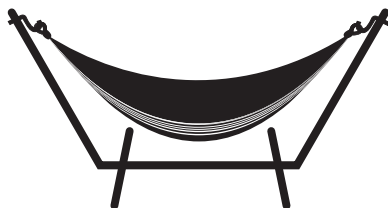

Hammocks will stretch by 5-10% after the first few uses. Adjustments can be made after each use to keep you and your hammock comfortable.



DO NOT exceed the maximum load of 200kgs.



DO NOT leave children or pets unattended in or near hammock.

Should you not want to use your included frame and would like to hang from a tree, beam or posts please follow the below guide. To hang your Two Trees hammock you will require two fixed points, such as trees, beams, posts, or dyna bolts into brick walls. Consult a qualified builder if unsure.



WARNING: Never use a free standing brick wall to hang your hammock.

Your Two Trees hammock will require a minimum of 3 metres between fixing points to get the ideal shape. Rope may be needed to attach one end of the hammock, it is recommended to use a double piece to avoid the hammock twisting.

Hang the hammock loops at roughly the same height. When the hammock is in use it should sit 20-30cm above the ground.

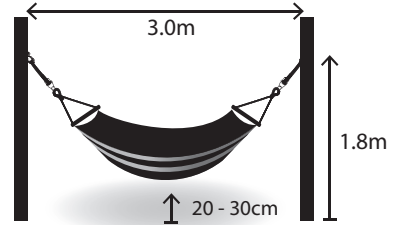

TEMPORARY INSTALLATIONS

For temporary installations, such as trees or beams, we recommend using the Two Trees hammock hanging kit (TT501HK). For more information about our installation products please visit our website (www.twotreeshammocks.com.au)

- 1** Place the cord around the pole or tree, then thread through the figure eight hook.
- 2** Thread the cord through the clamp hook and secure at desired length.
- 3** Repeat process for other side of hammock. Ensure both hooks are secure, place hammock ends over hooks.



PERMANENT INSTALLATIONS

We recommend using the Two Trees screw eye and hook (TT502HH). Always check with your qualified builder if unsure of safety.

For sturdy masonry walls (not air/hollow/single brick or besser block) a 10mm dyna bolt with a large washer and rope can be used.

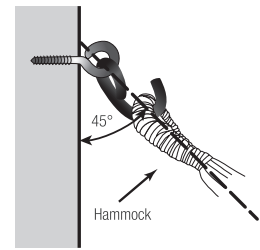
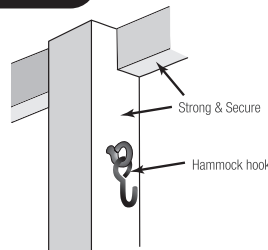

WARNING: DO NOT EXCEED THE MAXIMUM LOAD OF 200KGS

Read instructions before use and keep for future reference. Failure to read these instructions before use can lead to an increased risk of injury. When installing always check with a qualified builder for safety.

HOW TO RELAX IN YOUR HAMMOCK

1



Open the hammock fabric in the centre of the hammock and slowly and safely sit in the middle as you would in a chair.

2



Gently lie back on a diagonal with your head on the edge of the hammock.

3



Bring your feet in and stretch them out, so you are lying on a diagonal. This is the traditional way to relax in a classic style hammock.

CARING FOR YOUR HAMMOCK

To prolong the the life of your hammock and frame it is best to store away when not in use, as the sun and rain will deteriorate the construction over time. If using near the sea it is important to rinse your hammock regularly.

Prior to washing your hammock, tie a loose single knot in the suspension cords at both hanger ends. Machine wash with cold water on a regular cycle using non-bleach detergent. DO NOT tumble dry. DO NOT iron. Dry in shade.

STORING YOUR HAMMOCK

When storing your Two Trees hammock make sure hammock is clean and completely dry.

To prevent tangles place a knot in each suspension cord. Fold the hammock in half, with suspension cords together. Then fold the edges of the hammock to the centre, and roll the hammock up starting with the suspension cords. Store in a dry place.



LIST OF PARTS

A	Metal arm pipe with fixed screws, 42mm DIA x 1060mm	2
B	End angle tube	2
C	Center base spreader tube, 36mm DIA x 540mm	1
D	Metal stand pipe, 40mm DIA x 985mm	2
E	Plastic stand feet	4
F	Plastic inside collar	4
G	Plastic external collar	2
H	Tri-wing hand screws	10
I	Double polycotton hammock	1

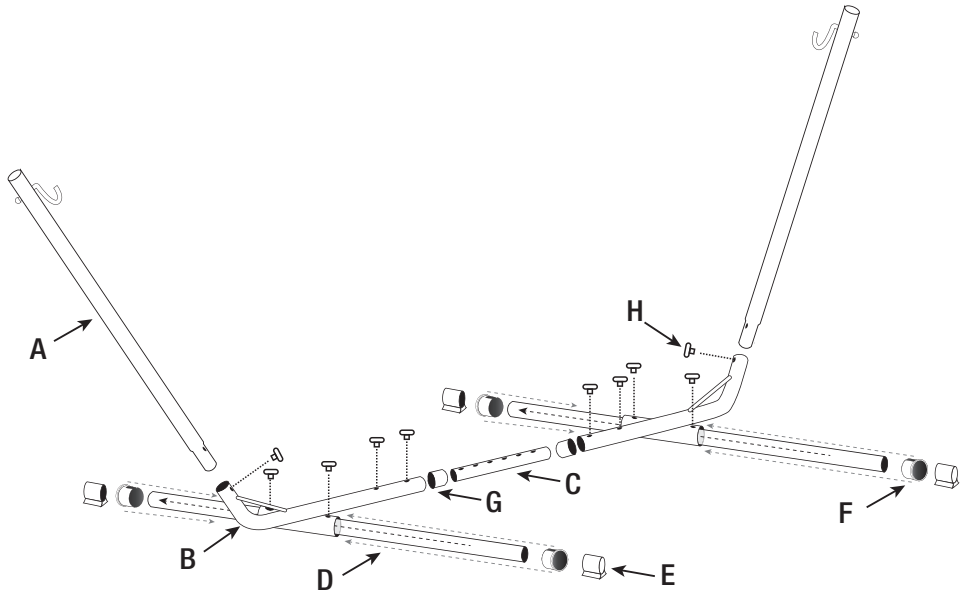

HAMMOCK STAND MIN SIZE: 310(L) x 100(W) x 100(H)cm
Suitable for hammocks with a minimum of 280cm from end to end



HAMMOCK STAND MAX SIZE: 330(L) x 100(W) x 100(H)cm
Suitable for hammocks with a maximum of 300cm from end to end

HAMMOCK FRAME ASSEMBLY INSTRUCTIONS

- 1**
- Place **F** (plastic inside collars) in either side of the small brace tube of **B** (end angle tube).
 - Insert **D** (metal stand pipe) into either side of the small brace tube of **B** (end angle tube).
 - Secure with **H** (tri wing hand screws).
 - Repeat on either side.

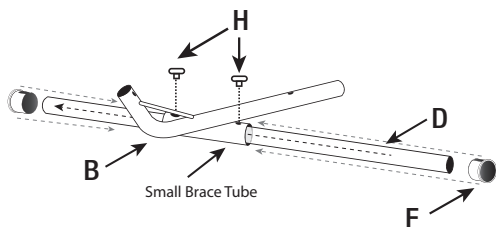

- 2**
- Insert **G** (plastic external collars) on straight end of either side of **B** (end angle tube).
 - Take **C** (centre base spreader tube) and join both **B** (end angle tubes) together.
 - Fix into place with four of **H** (tri wing hand screws).

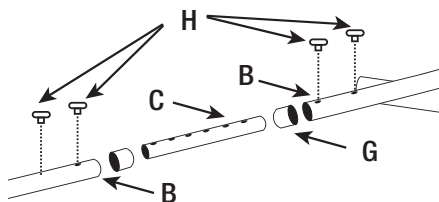

- 3**
- Attach **A** (metal arm pipe) on top angle end of **B** (end angle tube).
 - Fix into place with one of **H** (tri wing hand screws).
 - Repeat on other side.

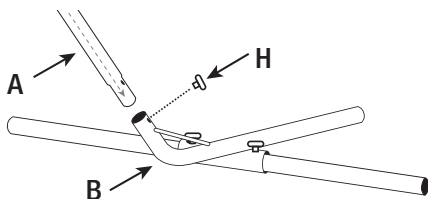

- 4**
- Take **E** (plastic stand feet) and attach to end of **D** (metal stand pipe).
 - Repeat on all sides.

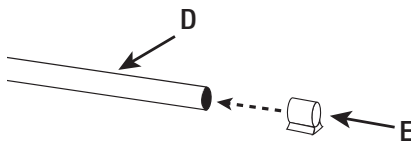

- 5**
- Attach **I** (double polycotton hammock) into the hooks at either end.
 - Ensure that the hammock and suspension cords are not twisted.

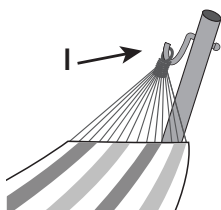

- 6**
- Ensure all tri wing hand screws are secured and tightened before use.
 - Ensure the hammock is set to the minimum size setting for initial use.
 - To adjust the length of your stand for your hammock, extend or shorten the fixtures on **C** (centre base spreader tube).

Note: Your hammock will hang taut on the initial set up. With use, your hammock will stretch and hang in a more relaxed position.

