



flyscreen door

LINK SCREEN

INSTALLATION INSTRUCTIONS



PROVIDES
AIRFLOW



EASY
INSTALL



Protect doorways and openings from insects while allowing air flow in.

- Maintain outdoor views
- Perfect for bi-fold and sliding doorways keeping out insects
- Additional doors can be joined to cover large openings
- Slimline design neatly retracts



You'll Need



TAPE MEASURE



SCREWDRIVER



DRILL



FINE BLADE SAW



DRILL BITS

2.5mm & 3mm for aluminium frame
6.5mm masonry if face mounting to brick

Components List



2x Handles
4x Handle screws (10mm)
4x Screw caps



4x Headrail screws
(13mm)



8x Frame screws
(25mm)



8x Frame screws
& wall plugs
(used for brick/masonry)

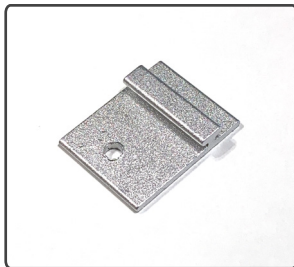

8x Face mount brackets
(only required for
face mounting)



1x Headrail connector
(only required
joining >2 doors)



4x Door connectors
(used for joining
>2 doors)

Contents

Recess Mount	pg 4
Face Mount	pg 6
Handle Installation	pg 8
Connecting Doors	pg 10

Link Screen Door Parts

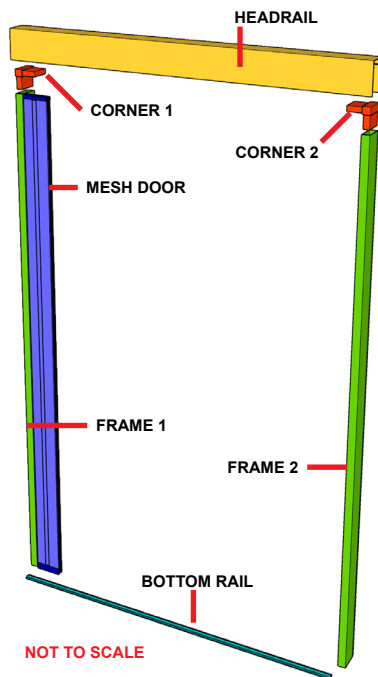

Recess Mount Instructions

SCAN ME



Scan the QR code to watch the recess mount installation guide video or use the following instructions.

STEP ONE

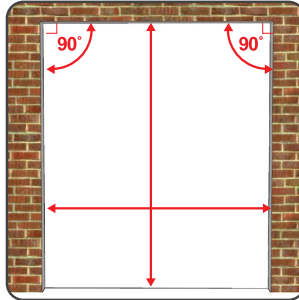

Measure opening width and height to ensure correct size requirements.

DOOR MUST BE LEVEL AND SQUARE

STEP TWO

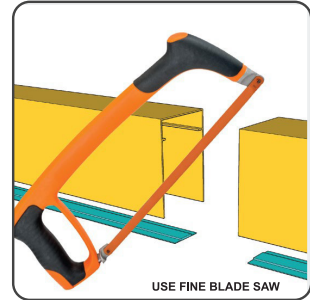

Door width can be altered to suit opening. Measure and trim headrail and bottom rail as required.

DOOR HEIGHT CANNOT BE ALTERED

STEP THREE

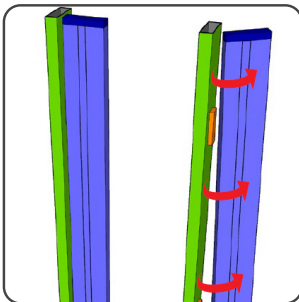

Door comes pre-fitted to one side of the frame. Using even pressure, twist/pull the door away from frame to allow for frame installation.

STEP FOUR

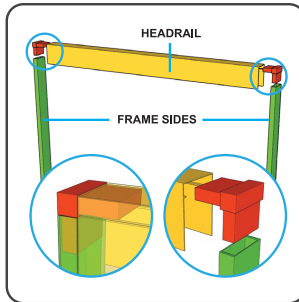

Construct door frame by connecting headrail and frame sides via corner piece.

STEP FIVE

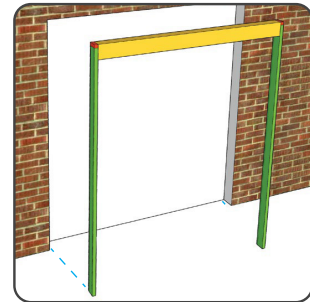

Position constructed frame into door opening. Ensure frame is square and level. Spin frame to set left/right operation (i.e. Having the hinges/door clips on the left will mean door will close from left to right).

STEP SIX

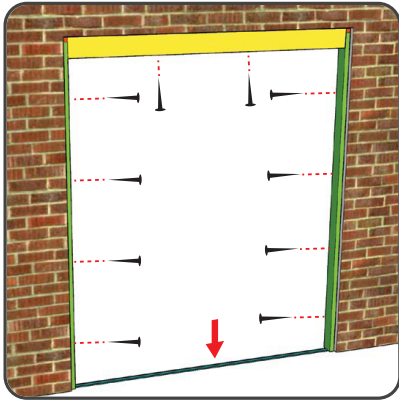

Secure door frame:

- Using a 3mm drill bit, drill pilot holes on frame sides and headrail.
- Secure frame sides with frame screws provided.
- Secure headrail with headrail screws provided.
- Clean base, align and apply bottom rail by peeling off double sided tape backing.

STEP SEVEN

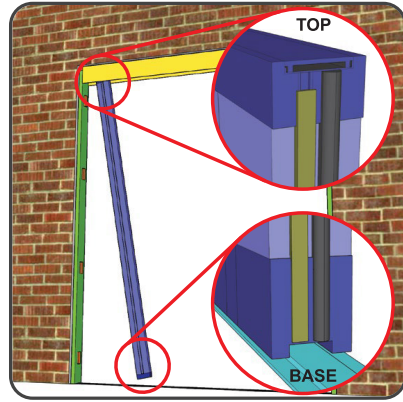

Install mesh door. Identify top and bottom as shown above. Angle door up/under the headrail and straighten against the side frame with connectors. Ensure base of door is sitting correctly on bottom rail.

STEP EIGHT

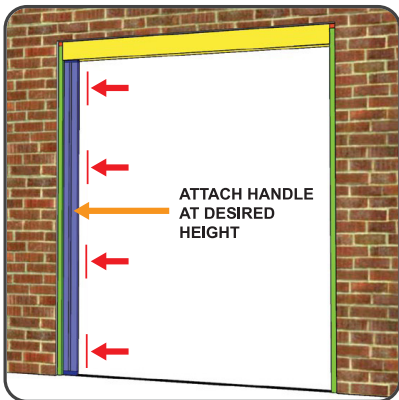

Using firm and even pressure, push door onto door clips (located on frame side) until door 'clicks' into place. Attach handle at desired height

(REFER TO PG 8 FOR DETAILED INSTRUCTIONS)

STEP NINE

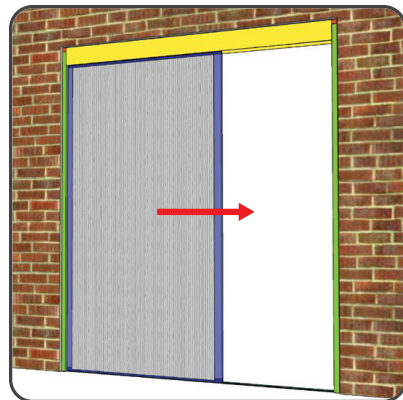

Test door to ensure smooth operation. Door should connect to magnetic closure at opposite end. Opposite end of frame has a magnetic strip and a weather seal.

Face Mount Instructions

SCAN ME



Scan the QR code to watch the face mount installation guide video or use the following instructions.

STEP ONE

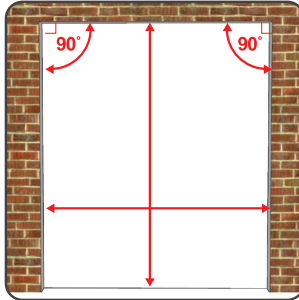

Measure opening width and height to ensure correct size requirements.

DOOR MUST BE LEVEL AND SQUARE

STEP TWO

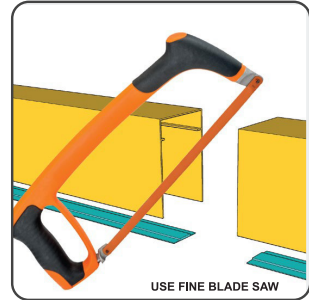

Door width can be altered to suit opening. Measure and trim headrail and bottom rail as required.

DOOR HEIGHT CANNOT BE ALTERED

STEP THREE

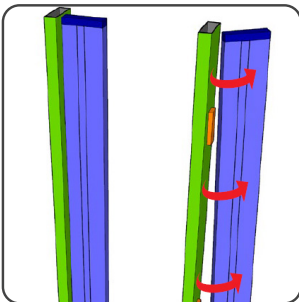

Door comes pre-fitted to one side of the frame. Using even pressure, twist/pull the door away from frame to allow for frame installation.

STEP FOUR

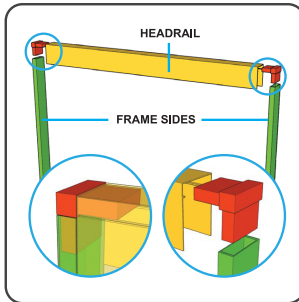

Construct door frame by connecting headrail and frame sides via corner piece.

STEP FIVE

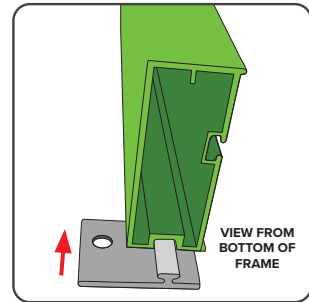

Starting from the bottom of one frame side, slide 4x brackets into the track (as shown above). Repeat this for the other frame side. Each side should have 4x brackets.

STEP SIX

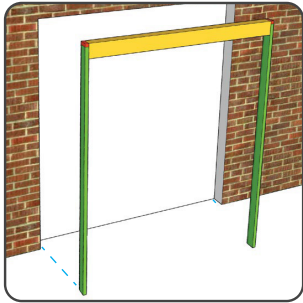

Position constructed frame into door opening. Ensure frame is square and level. Spin frame to set left/right operation (i.e. Having the hinges/door connector clips on the left will mean door will close from left to right).

STEP SEVEN

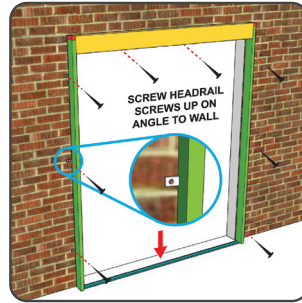

Secure door frame:

- Screw headrail screws up on angle to wall to secure headrail (Screws are self-drilling, 3mm pilot hole recommended if having difficulties).
- Position face mount bracket into place by sliding up/down the frame. Secure with frame screws. If mounting onto brick/masonry, use frame screws+wall plugs set. Pre drill with 6.5mm masonry drill bit. Insert wall plug, secure brackets with screws.
- Clean base, align and apply bottom rail by peeling off double sided tape backing.

STEP EIGHT

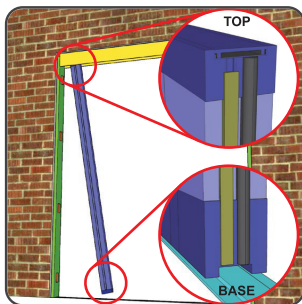

Install mesh door. Identify top and bottom as shown above. Angle door up/under the headrail and straighten against the side frame with connectors. Ensure base of door is sitting correctly on bottom rail.

STEP NINE

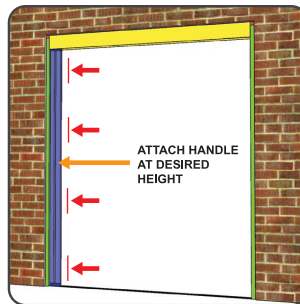

Using firm and even pressure, push door onto door clips (located on frame side) until door 'clicks' into place. Attach handle at desired height

(REFER TO PG 8 FOR DETAILED INSTRUCTIONS)

STEP TEN

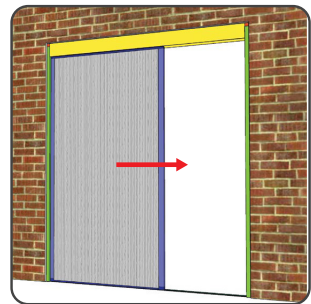

Test door to ensure smooth operation. Door should connect to magnetic closure at opposite end. Opposite end of frame has a magnetic strip and a weather seal.

Handle Attachment

STEP ONE

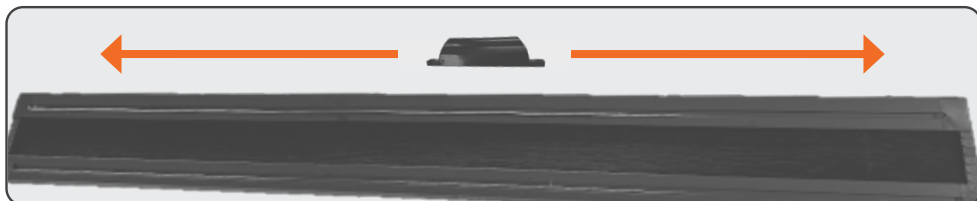

Determine the desired placement of handle on mesh door.

STEP TWO

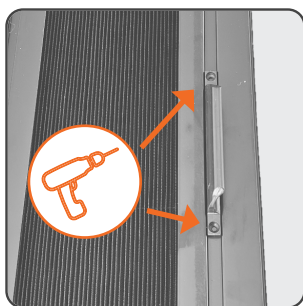

Ensure handle is facing correct way in-line with door opening operation

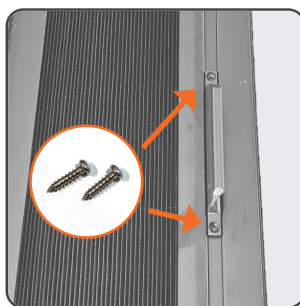

Place handle on the concave strip of door at the desired height.

Carefully drill pilot hole (2.5 mm drill bit) and use handle screws provided to secure.

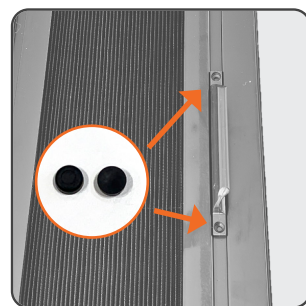

Place handle screw caps to cover exposed screws.

STEP THREE

Repeat step 2 on opposite side of door ensuring handle is facing correct way in-line with door opening operation



Connecting Multiple Doors

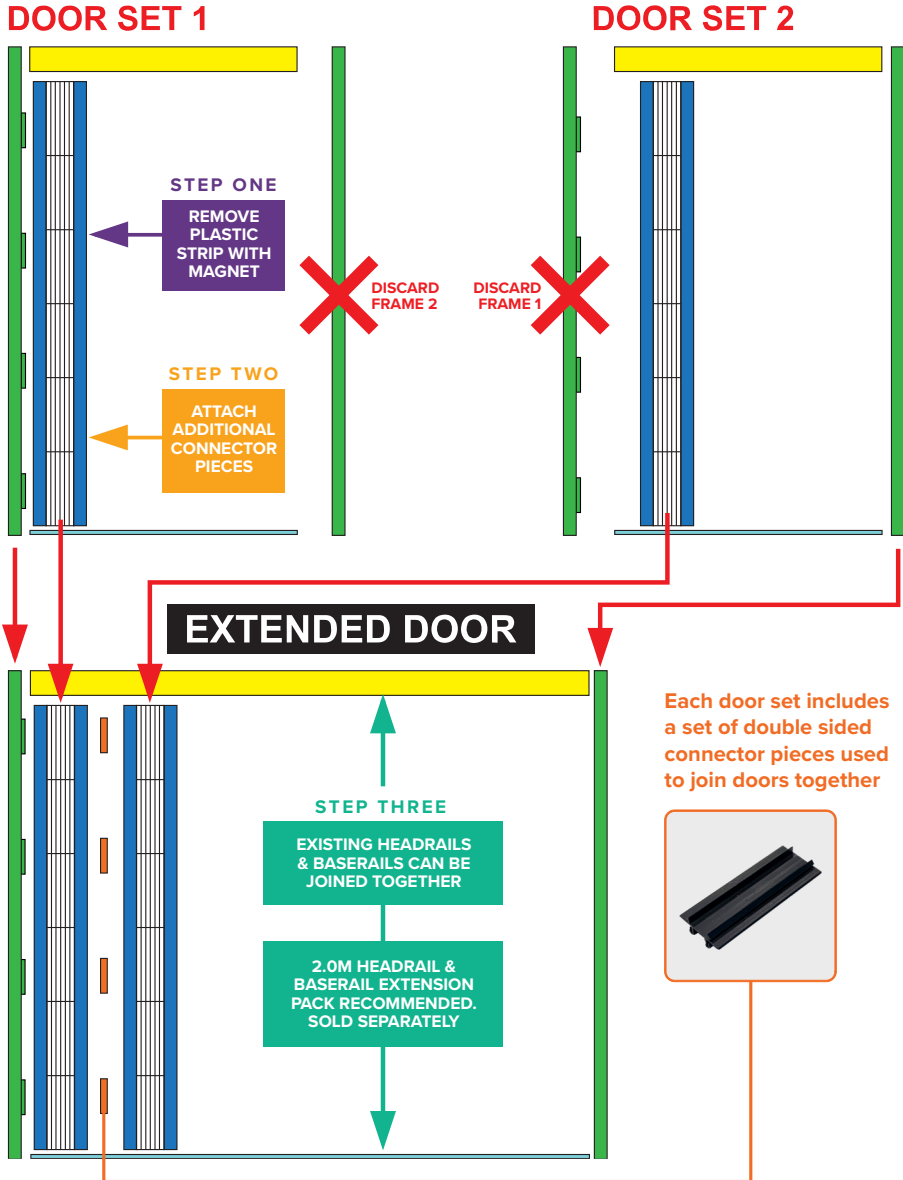

STEP ONE

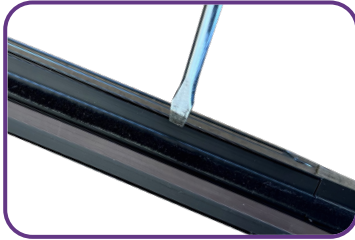

Plastic strip with magnet is located on the side of the mesh door.

Gently insert a flat head screwdriver along the border of the plastic strip, 'pop'/remove the strip from the mesh door frame.

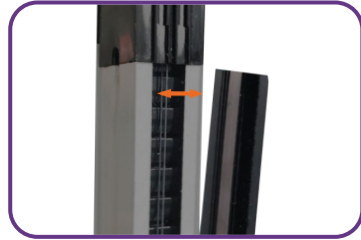

Discard strip.

STEP TWO

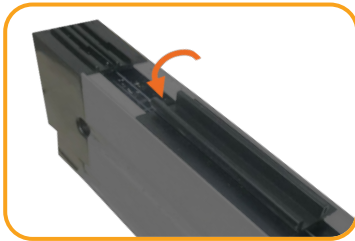

After the plastic strip is removed, add door connector pieces.

Insert the 4x connector pieces onto the exposed mesh door frame. Press in firmly to ensure placement.

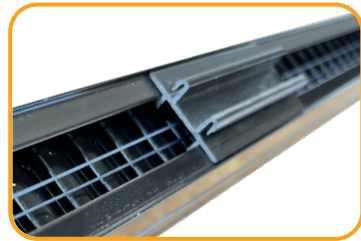

Once connectors are in place, additional door can be joined together.

STEP THREE

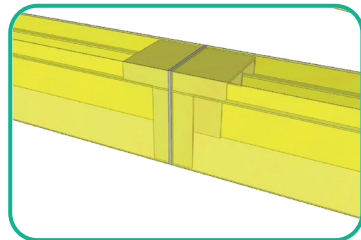
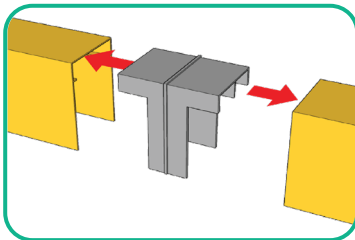

Two or more headrails can be connected by using the headrail connector provided. Align and slide the headrail into the connector.

Optional: Alternatively use 2m Headrail & Base Extension Pack for a seamless and smooth operation. Headrail and Base Extension Pack sold separately.

PILLAR



Pillar Products PTY LTD
pillarproducts.com.au

48-50 Access Way,
Carrum Downs VIC 3201
1300 155 355
info@pillarproducts.com.au

WARRANTY



To register your purchase for our warranty, scan here and complete the steps. For any other issues please contact the bunnings store of purchase.