

YOUR HEADACHE-FREE GUIDE TO RACK IT LIKE A BOSS

You've got this. We know because you take pride in your passions. Take care of your stuff. That's why you purchased this Rack It PRO Deep Single Drawer. You're particular. And we like that. Because we know you'll take the time to check off all the Parts listed below and to read through these Assembly Instructions before you start. Cue Farnsey (or Beyoncé - whatever lifts you). **Let's do this.**

HOUSING PARTS:



PART A - BOTTOM PANEL x 1

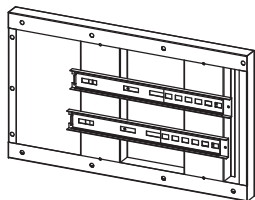

PART B - RIGHT SIDE PANEL x 1

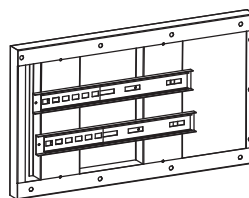

PART C - LEFT SIDE PANEL x 1



PART D - BACK PANEL x 1



PART E - TOP PANEL x 1



PART F - M6 SCREW x 32 (+2 spare)

DRAWER PARTS:

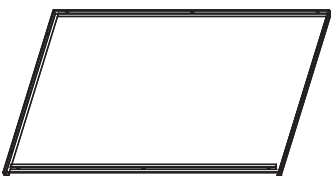

PART G
DRAWER BOTTOM x 1

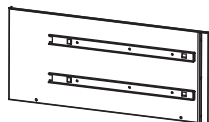

PART H
DRAWER PANEL x 1



PART I
DRAWER PANEL x 1

Front Edge



PART J - DRAWER BACK x 1



PART K - DRAWER FRONT x 1



PART M -
M4 SCREW x 20 (+4 spare)
(for Drawer Assembly)

PLEASE NOTE: If using an electric screwdriver only loosely tighten screws, finish tightening with hand screwdriver to avoid damage.

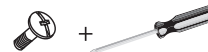

STAGE 1: BOX IT

STEP 1

Your Drawer starts here.
With Bottom Panel (A).
Like the foundations of a house.
So when you're fixing on Side Panels (B & C),
think: do I want to rush the foundations?
The answer is, of course, no way.

Screw holes at the back of Bottom Panel A

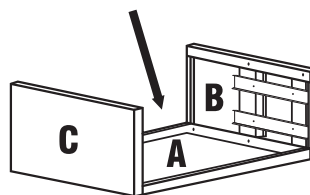

Hot tips:

1. Make sure the pre-punched screw holes on Bottom Panel (A) are to the back.
2. Make sure the narrowest gap between the boxy ridges on the interior and the front edge of each Side Panel is to the front.

STEP 2

Fix off your Back Panel (D), followed by your Top panel (E). You've boxed It.
Cue roof shout! And let's move onto Stage 2...

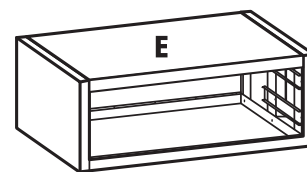
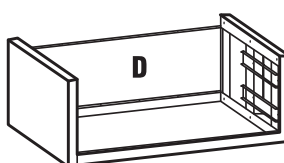

STAGE 2: DRAWER IT

STEP 1

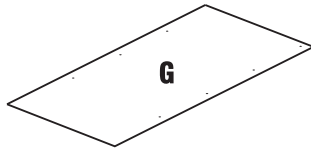

Place your Drawer Bottom (G) on your familiar flat surface. Flat side up!
And with the 3x threaded holes to the back.

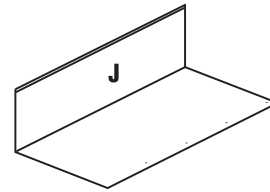

Screw fix on your Back Panel (J) first (this is important).

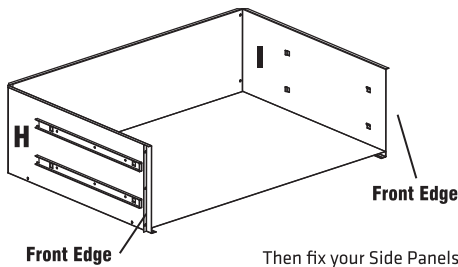

Then fix your Side Panels (H & I).

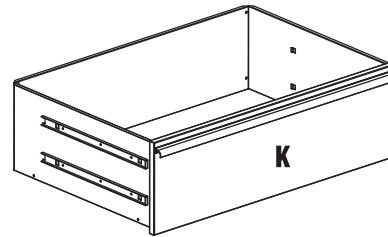

Followed Small Front Panel (K).

STAGE 3: RACK IT

STEP 1

If you're screw fitting your Drawer to a Rack It MDF Shelf, now is the time to do so. Pick 2x self-tapping screws no longer than 15mm, and fix the Unit down through the 2x Screw Holes in the Bottom Panel.

Fix screws through the holes

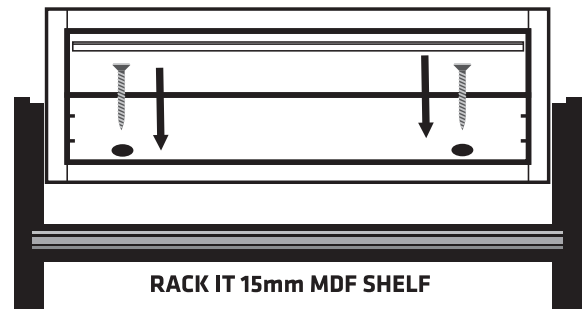

STEP 2

The final assembly is made easier (and more enjoyable) with a friend. Celebrate together as you slide this baby home... Carefully line up the Inner and Outer Runners on the Drawer. Once all 4x Runners are touching, gently push the Drawer closed. Easy does it: you might need to slightly open and close the Drawer a few times before it all falls into place.

Hot tips:
This can be fiddly, it's way easier with 2x people. Be patient, and kind to one another. We're almost done.

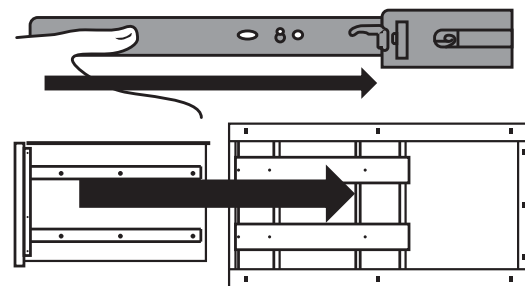

You've done it! Cue warm inner feeling of satisfaction.

Stand back and marvel at your Rack It PRO Deep Single Drawer. Now all that's left to do is select your precious stuff to store inside. Now is also the time to enjoy tossing these instructions in the recycling.

We knew you had it in you!