

68mm | High Security Hasp & Staple

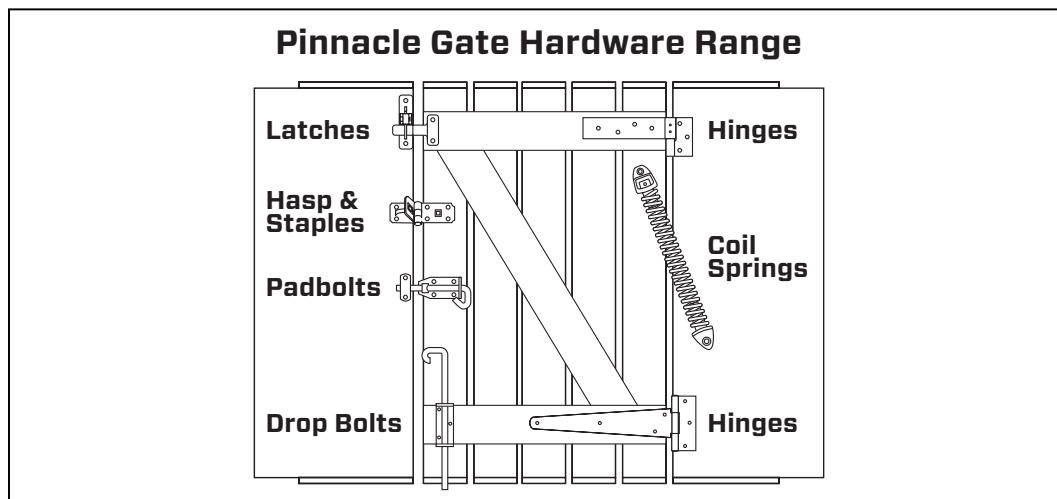
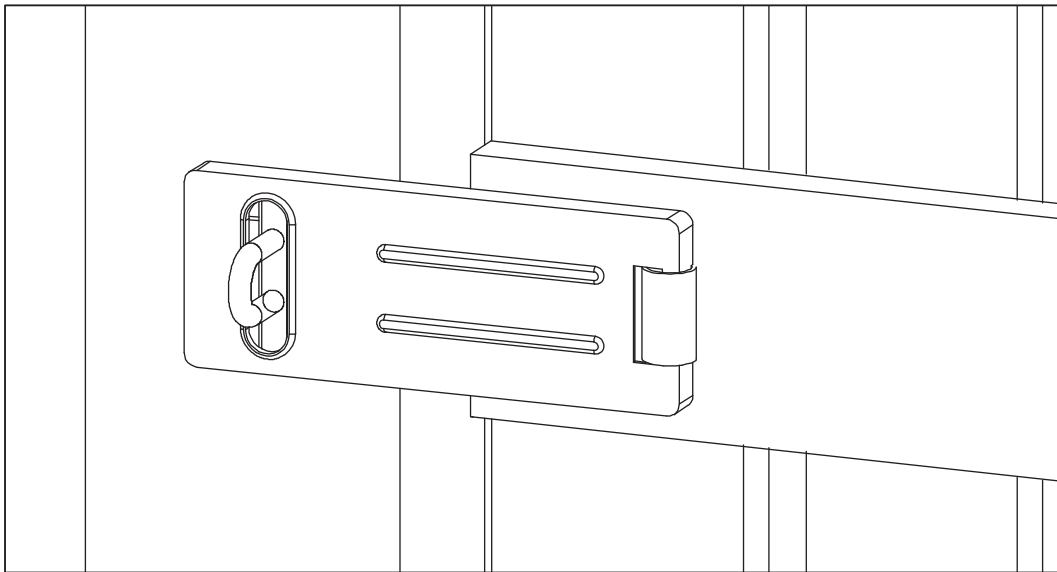

Tools required: Pencil, No.2 Phillips screwdriver, drill and 2mm drill bit.

Installation instructions:

1. Place hasp and staple in location to ensure that it functions as intended.
2. Mark screw locations and drill pilot holes with 2mm drill bit. Fasten with screws. Please ensure you do not over tighten as this is not recommended.



Corrosion Protection Chart

Finish:	Rating:
Stainless Steel	Ultimate 
Galvanised	High 
Zinc Plated	Moderate 

Suitable for model no: GHS051.

CONNECT WITH US!
PINNACLE.NET.AU

