

EASYDRAIN STANDARD | EASYDRAIN COMPACT | EASYDRAIN EDGE
TECHNODRAIN & EVOMAX | FLO-WAY & RAINWATER



EVERHARD SURFACE WATER DRAINAGE

Australian made, eco-friendly drainage solutions for the home

SELECTING THE SYSTEM THAT'S RIGHT FOR YOU

EasyDRAIN
STANDARD

EasyDRAIN
COMPACT

EasyDRAIN
EDGE

TechnoDRAIN
& EvoMAX

Flo-way &
Rainwater

Everhard's extensive range of surface water drainage systems are designed for various residential & commercial outdoor drainage projects and made to withstand Australia's harsh weather and environmental conditions. Surface water drainage is essentially the removal of excess water from the surface and into a drainage system in a controlled manner, as quickly and effectively as possible.

WHAT ARE THE DIFFERENT SYSTEMS?

EasyDRAIN STANDARD

- / 100mm internal channel depth profile is suitable for medium to high rainwater levels and water flow
- / Made in Australia and manufactured from 100% recycled polymer
- / Comes complete with a range of galvanised steel, stainless steel and polymer grate options - See Grate Guide for complete list

EasyDRAIN COMPACT

- / 80mm internal channel depth profile makes for easy installation and is suitable for areas with medium to low rainfall and water flow
- / Comes complete with heel-friendly grates. Available in black polymer or galvanised steel
- / Ideal for walkways, landscaped areas, patios and gardens

EasyDRAIN EDGE

- / Architectural slot drainage design - only 20mm visible
- / Made in Australia and manufactured from 100% recycled polymer
- / Installed under the surface for invisible look
- / Ideal for coastal areas, around swimming pools, patios and decking

TechnoDRAIN & EvoMAX

- / 150mm and 200 internal channel width profiles available, suitable for high rainfall water flow areas
- / Available with Class B and Class D grates for light vehicle traffic, car parks and driveways
- / Can be used for residential and commercial purposes

Flo-way & Rainwater

- / Range of shallow and deep pits for surface water collection
- / Leaf and debris catchment accessories available
- / Integrates with any of the EasyDRAIN ranges

CHANNEL COMPARISONS

EasyDRAIN Compact



EasyDRAIN Standard
EasyDRAIN Edge



TechnoDRAIN &
EvoMAX 150H

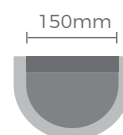

TechnoDRAIN &
EvoMAX 200H

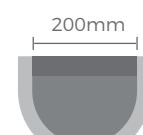



HANDY HINT
 Before selecting drainage, consider how much water will go into it and what it will be exposed to

EASYDRAIN GRATE GUIDE

MATERIAL	FEATURES	CHANNEL	CORNER	TEE	SLIM PIT
STANDARD BLACK POLYMER	<ul style="list-style-type: none"> Made in Australia, manufactured from 100% recycled polymer Suitable for: residential driveways, pathways, gardens and any salt affected areas (pools, coastal areas) Flow rate: 417L/min/metre* 				
HEEL FRIENDLY BLACK POLYMER	<ul style="list-style-type: none"> Made in Australia, manufactured from 100% recycled polymer Suitable for: residential driveways, pathways, gardens, pedestrian areas and any salt affected areas (pools, coastal areas) Flow rate: 175L/min/metre* Adheres to industry standard - AS1428 designed for access and mobility 				
EDGE BLACK POLYMER	<ul style="list-style-type: none"> Made in Australia, manufactured from 100% recycled polymer Suitable for: residential driveways, pathways, gardens, pedestrian areas and any salt affected areas (pools, coastal areas) Flow rate: 149L/min/metre* Adheres to industry standard - AS1428 designed for access and mobility 				
PRESSED GALVANISED STEEL	<ul style="list-style-type: none"> Suitable for: residential driveways** and pathways Not Suitable for: salt and chemical affected areas (pool, coastal areas) Flow rate: 230L/min/metre* 				
PRESSED STAINLESS STEEL	<ul style="list-style-type: none"> Suitable for: residential driveways** and pathways Not Suitable for: salt and chemical affected areas (pool, coastal areas) Flow rate: 458L/min/metre* 				
EURODESIGN 316 STAINLESS STEEL	<ul style="list-style-type: none"> Suitable for: residential driveways**, pathways, gardens, pedestrian areas and any salt affected areas (pools, coastal areas) Adheres to industry standard - AS1428 designed for access and mobility 				
GALVANISED ROUND BAR	<ul style="list-style-type: none"> Suitable for: residential driveways and pathways Not Suitable for: salt and chemical affected areas (pool, coastal areas) Adheres to industry standard - AS1428 designed for access and mobility 				

EasyDRAIN Grates are the only ones interchangeable - these grates will not suit TechnoDRAIN or EvoMAX

*This all depends on a heap of different variables, but if we make a like-for-like comparison assuming a 1 in 200 site gradient and catchment area of 250m²

**Flat upper surface of metal grates may show signs of slight indentation over time if used in a driveway



A GUIDE TO

EasyDRAIN STANDARD

Specifications, Features and Benefits

EasyDRAIN Standard is a click together drainage system designed for outdoor applications, medium to high rainfall areas and areas with a medium to high water flow. With an internal channel depth of 100mm and components to suit various configurations, ensures the system can effectively hold and distribute water efficiently throughout the drainage system.

EASYDRAIN STANDARD INSTALLED

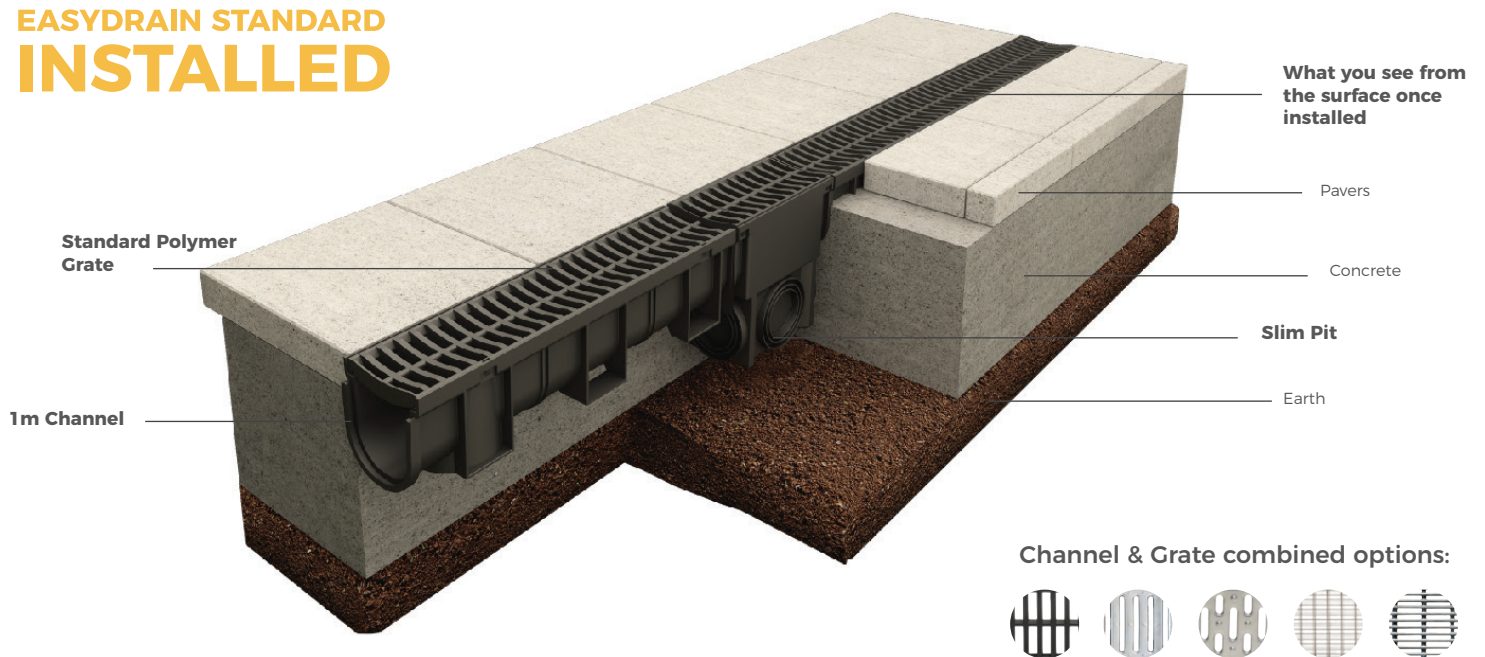

Features and Benefits

- ✓ All channels and polymer grates are made in Australia and manufactured from 100% recycled polymer
- ✓ The largest of the EasyDRAIN Ranges - available in polymer, pressed galvanised steel, pressed stainless steel, Eurodesign 316 stainless steel and galvanised round bar grates.
- ✓ All grates are interchangeable with any of the EasyDRAIN channels
- ✓ Ideal for medium to high water flow and rainfall applications
- ✓ Designed to fit any project, including common applications - residential driveways, swimming pools (polymer or eurodesign grates), patios, landscaped areas, walkways, outdoor entertaining areas and balconies.
- ✓ Channel is moulded with bottom outlets that connect to 75mm, 90mm or 100mm PVC pipes
- ✓ Once correctly installed in concrete, polymer and galvanised round bar grates are rated to 1.5 tonne wheel loads

HANDY HINT

You'll need a converter to connect two male channel ends together or connect a corner to a male end of channel

Pictured: 83300

A GUIDE TO EasyDRAIN STANDARD

Specifications, Features and Benefits

CHANNEL & GRATE

Available in 1m and 3m lengths. Collects and distributes water away from around the area

- Available in a range of grate options in Polymer, Galvanised Steel and Stainless Steel
- Comes in 1 metre and 3 metre lengths. Easily join together and with other components by simply clicking together
- 100mm profile to capture large volume of water flow - ideal for heavy rainfall areas

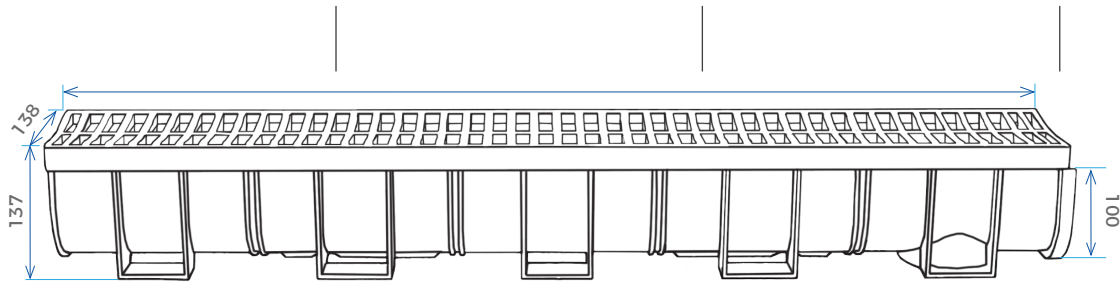

- 200mm paver-length segments moulded into channel, allowing for easy cutting and rejoining with converter

- Black polymer channel and grate made from tough, recycled UV stabilised polymer - ideal for driveways and all outdoor areas

- Connects to 75mm, 90mm and 100mm pvc pipe

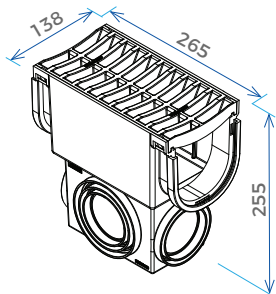

SLIM PIT

Allows seamless connection to 75mm, 90mm and 100mm pvc stormwater pipe. Connects to the EasyDRAIN Channel

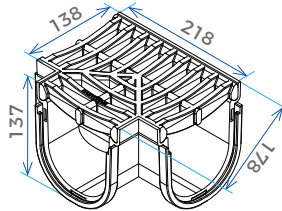

TEE PIECE

Allows for easy change of direction. Connects to the EasyDRAIN Channel

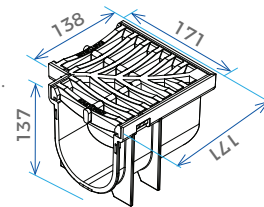

CORNER

Allows for easy change of direction. Connects to the EasyDRAIN Channel

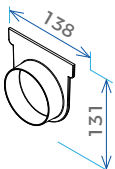

END CAP

Provides a finishing point at the end of the EasyDRAIN Channel. Also allows for stormwater connection at the end of the EasyDRAIN Channel

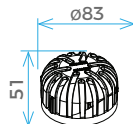

LEAF DOME

Provides a barrier against leaves and other debris from entering waterways. Suitable for all ranges

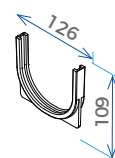

CONVERTER

Acts as a joiner between cut ends of EasyDRAIN channel by converting a male end into a female end

A GUIDE TO EasyDRAIN COMPACT

Specifications, Features and Benefits

EasyDRAIN Compact is a shallow click together drainage system designed for outdoor applications, medium to low rainfall areas and areas with a medium to low water flow. With an internal channel depth of 80mm and components to suit various configurations, ensures the system can effectively hold and distribute water efficiently throughout the drainage system

EASYDRAIN COMPACT INSTALLED

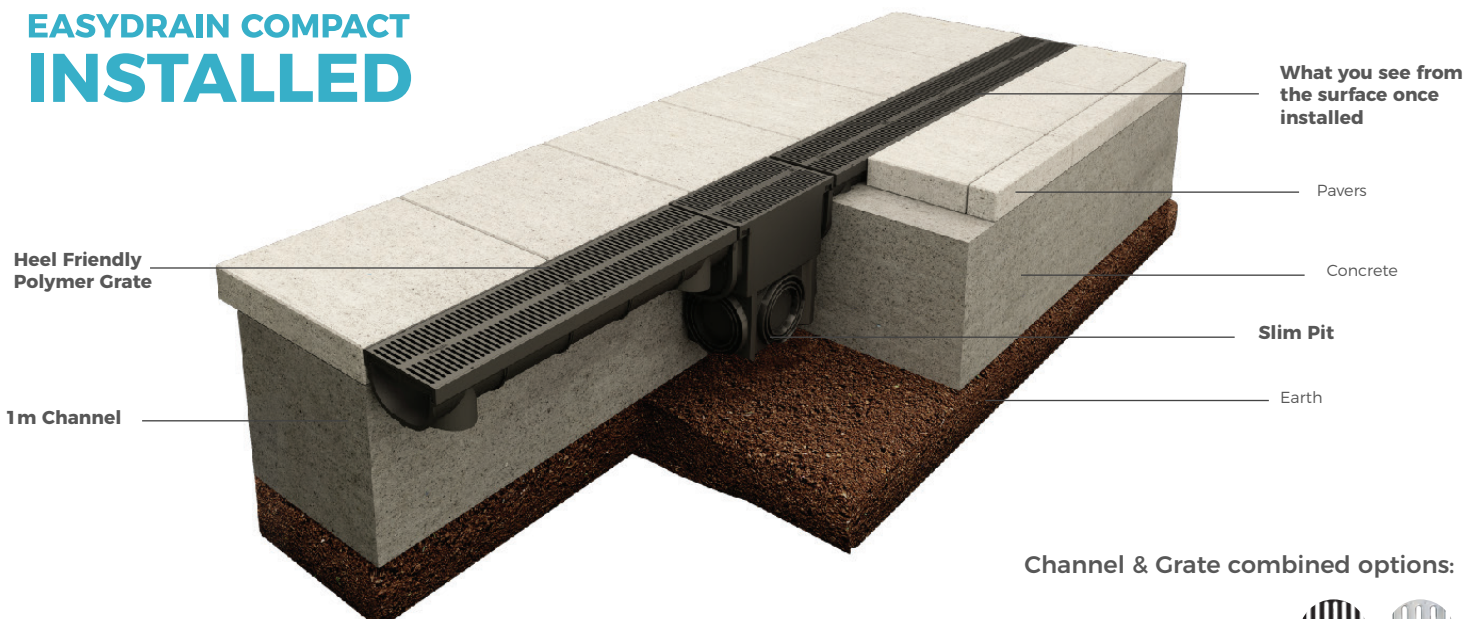

Features and Benefits

- / All channels and polymer grates are made in Australia and manufactured from 100% recycled polymer
- / Available in heel friendly polymer and galvanised stainless steel
- / All grates are interchangeable with any of the EasyDRAIN channels
- / Ideal for medium to low water flow and rainfall applications
- / Designed to most projects, including common applications - swimming pools, patios, landscaped areas, walkways, outdoor entertaining areas and balconies.
- / Channel is moulded with bottom outlets that connect to 75mm, 90mm or 100mm PVC pipes
- / Designed for access and mobility, heel friendly grate adheres to industry standards AS1428 whilst having gaps of less than 10mm



Pictured: 83500

Our EasyDRAIN COMPACT system is the only complete system in the market with a shallow 80mm profile, making it ideal for low rainfall and low water flow areas

COMPACT CHANNEL & GRATE

Available in 1m and 3m lengths. Collects and distributes water away from areas around the home

- Comes standard with heel friendly grate options in black polymer and galvanised steel
- Comes in 1 metre and 3 metre lengths that easily join together and with other components by simply clicking together
- Black polymer grate and channel made from tough, recycled UV stabilised polymer - ideal around swimming pools and in coastal areas

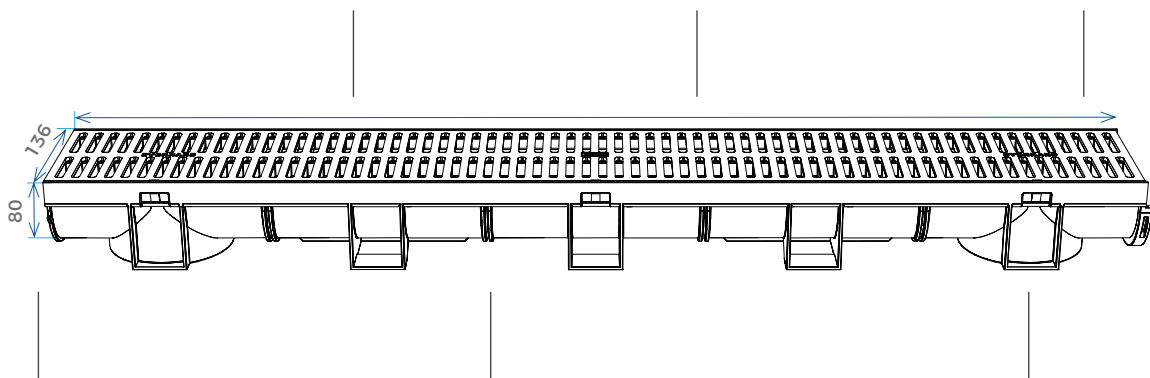

- Shallow 80mm profile allows for quick installation - ideal for low rainfall areas
- 200mm paver-length segments moulded into channel, allowing for easy cutting and rejoining with converter
- Connects to 75mm, 90mm and 100mm pvc pipe

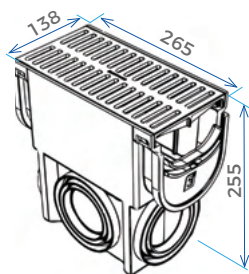

COMPACT SLIM PIT

Allows seamless connection to 75mm, 90mm and 100mm pvc stormwater pipe. Connects to the EasyDRAIN Compact Channel

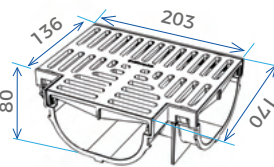

COMPACT TEE PIECE

Allows for an easy change of direction. Connects to the EasyDRAIN Compact Channel

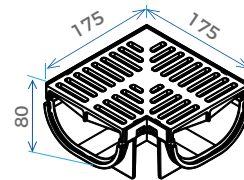

COMPACT CORNER

Allows for an easy change of direction. Connects to the EasyDRAIN™ Compact Channel

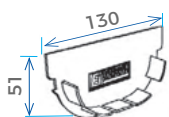

COMPACT END CAP

Provides a finishing point at the end of the EasyDRAIN Compact Channel

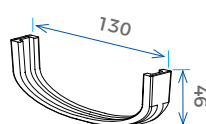

COMPACT CONVERTER

Acts as a joiner between cut ends of EasyDRAIN Compact Channel by converting a male end into a female end

HANDY HINT

Galvanised grates are not suitable around swimming pools or environments affected by salt water

Note: All measurements are in millimetres. Dimensions may vary due to the nature of polymer



Pictured: 83210

A GUIDE TO EasyDRAIN EDGE

Specifications, Features and Benefits

EasyDRAIN Edge is an architectural and sustainable drainage system that is installed completely underground revealing a small 20mm slot of complete water capture. The system creates new landscaping opportunities for areas such as patios and swimming pools without compromising on water collection needs. Edge has been tested to handle a water flow of 149L per metre per minute.

EASYDRAIN EDGE INSTALLED



Features and Benefits

- ✓ All channels and polymer grates are Made in Australia and manufactured from 100% recycled polymer
- ✓ Available in heel friendly polymer and galvanised stainless steel
- ✓ All grates are interchangeable with any of the EasyDRAIN channels
- ✓ Ideal for medium to low water flow and rainfall applications
- ✓ Architectural drainage that is best suitable to areas where aesthetics are important, including: around swimming pools, patios and outdoor entertaining areas
- ✓ Channel is moulded with bottom outlets that connect to 75mm, 90mm or 100mm PVC pipes
- ✓ Designed for access and mobility, adheres to industry standards AS1428 when using the heel friendly insert



A GUIDE TO EasyDRAIN EDGE

Specifications, Features and Benefits

EDGE CHANNEL & GRATE

- 20mm opening is the only visible part of the drainage once installed

- Black polymer grate and channel made from tough, recycled UV stabilised polymer - ideal around swimming pools and in coastal areas

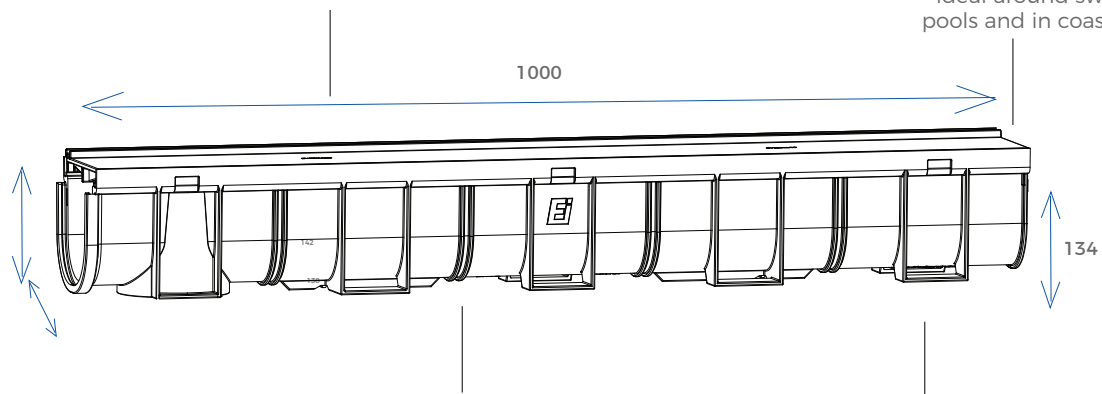

- 200mm paver-length segments moulded into channel, allowing for easy cutting and rejoining with converter

- Connects to 75mm, 90mm and 100mm pvc pipe

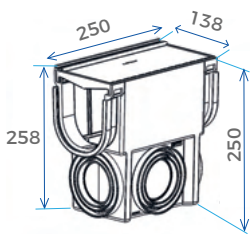

EDGE ACCESS PIT

Allows seamless connection to 75mm, 90mm and 100mm pvc stormwater pipe. Connects to the EasyDRAIN Edge Channel

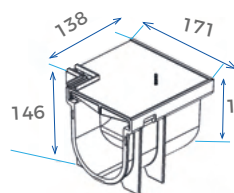

EDGE INTERNAL CORNER & GRATE

Allows for an easy change of direction. Connects to the EasyDRAIN Edge Channel

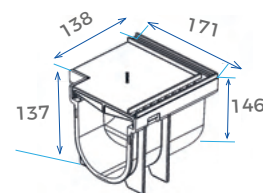

EDGE EXTERNAL CORNER & GRATE

Allows for an easy change of direction. Connects to the EasyDRAIN Edge Channel

EDGE HEEL FRIENDLY INSERT

Placing into the 20mm opening, allows the drainage to be heel and wheelchair friendly

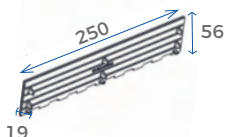

END CAP

Provides a finishing point at the end of the EasyDRAIN Channel. Also allows for stormwater connection at the end of the EasyDRAIN Channel

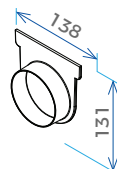

LEAF DOME

Provides a barrier against leaves and other debris from entering waterways. Suitable for all ranges

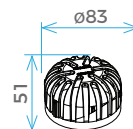

CONVERTER

Acts as a joiner between cut ends of EasyDRAIN channel by converting a male end into a female end

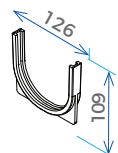



A GUIDE TO TechnoDRAIN & EvoMAX

Specifications, Features and Benefits

TechnoDRAIN and EvoMAX drainage systems are built for driveways and parking lots which support areas of light vehicle traffic - up to Class B and TechnoDRAIN Pro supports loads up to Class D making it a suitable drainage system for commercial car parks and unloading areas for heavy motor vehicles.

TECHNODRAIN & EVOMAX INSTALLED

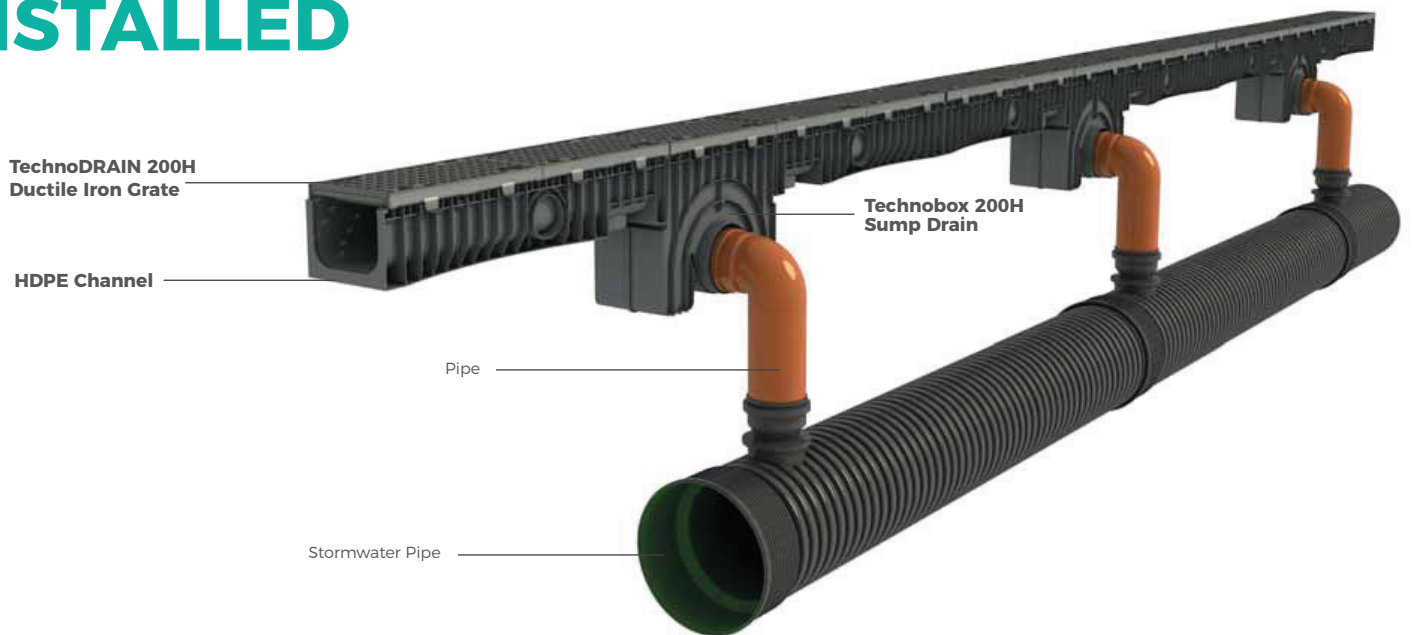

Features and Benefits

- ✓ Made from durable HDPE (high density polyethylene) material
- ✓ Strong, unbreakable and shock resistant
- ✓ Resists a wide range of acids, salts and hydrocarbons - TechnoDRAIN can be used in chemical plants, workshops and service stations
- ✓ Ideal for high water flow and rain flow areas
- ✓ With a coefficient high flow rate, the TechnoDRAIN surface does not obstruct the flow of water and reduces the deposit of aggregates
- ✓ Channel is moulded with bottom outlets that connect to 110mm PVC pipes
- ✓ EvoMAX is available with Class B grates and TechnoDRAIN has Class D grates



Pictured: 81503

A GUIDE TO TechnoDRAIN & EvoMAX

Specifications, Features and Benefits

TECHNODRAIN & EVOMAX CHANNEL & GRATE - 150H

- Ideal for commercial and residential use with high water flow

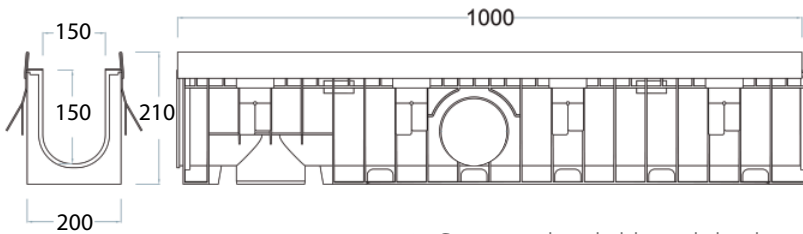

- Strong, unbreakable and shock-resistant

TECHNODRAIN & EVOMAX END CAP

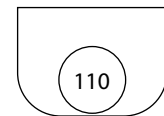

- Available in 150H or 250H
- Provides an end point for the drainage, comes with 110mm pre-shaped outlet for seamless connection to stormwater pipes

TECHNODRAIN & EVOMAX CHANNEL & GRATE - 200H

- Ideal for commercial and residential use with high water flow

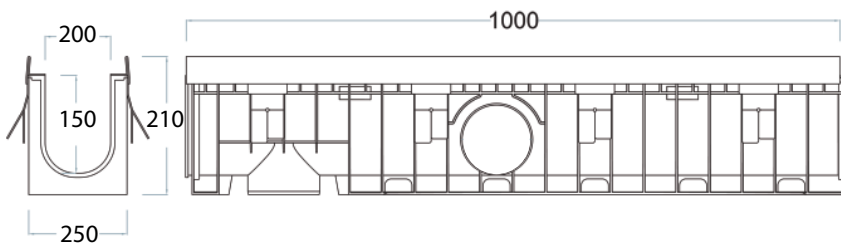

- Strong, unbreakable and shock-resistant

TECHNOBOX 200H SUMP DRAIN

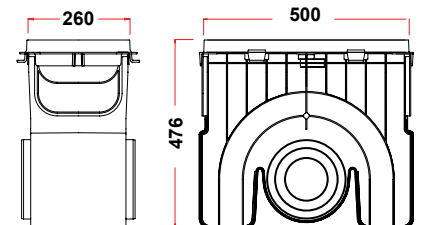

- Allows seamless connection to stormwater pipes - fits together with TechnoDRAIN 200H Channel

Note: All measurements are in millimetres. Dimensions may vary due to the nature of polymer



A GUIDE TO Flo-way & Rainwater Pits & Grates

Specifications, Features and Benefits

Flo-way and Rainwater Pits are designed for use under garden taps, downpipes or any location where surface water collects however is not exposed to vehicle traffic. Everhard's pits are designed to suit 90mm or 100mm PVC pipes with additional components in the range to help secure the stormwater connection points and accessories that catch debris ensuring it won't end up in waterways or block the drainage system.

RAINWATER PIT INSTALLED

The way the Rainwater Pit connects to the EasyDRAIN Channel and Grate, connected pipe and sits under the downpipe from the roof gutter, would work the same as using a Flo-way. It simply has a smaller capacity to hold rainwater/overflow.

Grate Options:

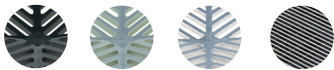

Pipe - typically connected to stormwater pipe or waste line to road

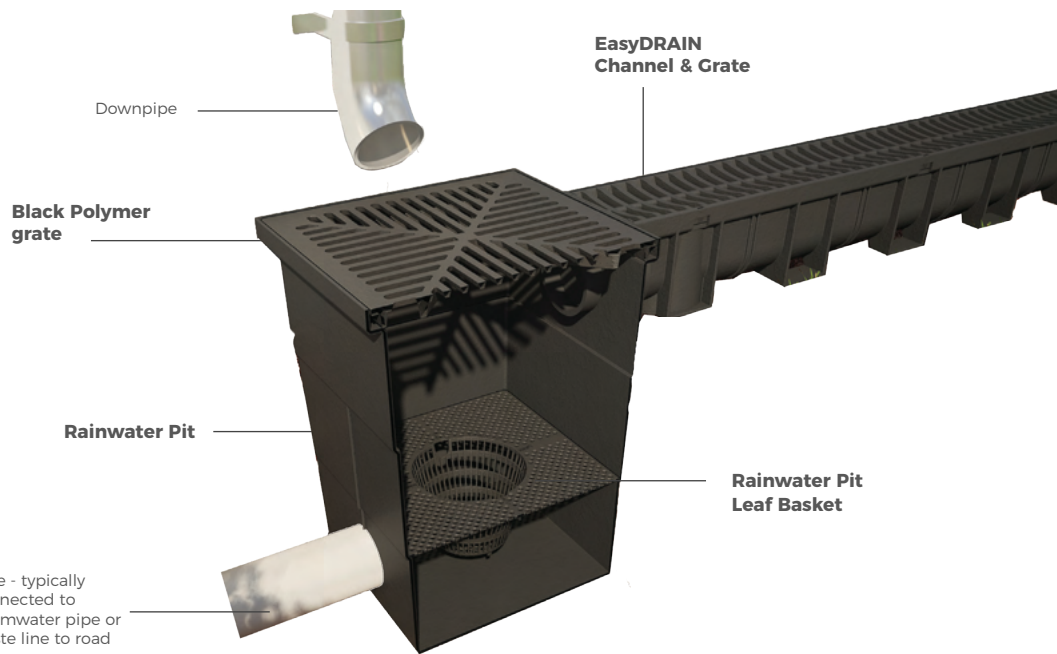

Features and Benefits

- ✓ The Flo-way Pit square trap design funnels rainwater directly into a connected stormwater pipe
- ✓ Flo-way Pits come complete with grate, available in a range of materials
- ✓ Rainwater Pits are designed as a drainage collection point by itself or for connection to the EasyDRAIN Channel and Grate System
- ✓ Rainwater Pits and Grates come separately or complete with black polymer or aluminium grate
- ✓ Easy to install into any domestic or non traffic-able application
- ✓ Suits 90mm or 100mm PVC Pipe
- ✓ Made from UV stabilised polymer material
- ✓ Black polymer is made from 100% recycled plastic
- ✓ Polymer pits and black polymer grates are made in Australia

HANDY HINT

Where rainwater pits are connecting to a stormwater pipe, we recommend using a Pit Boss for seamless connection

Pictured: 84767

A GUIDE TO Flo-way™ / Rainwater Pits & Grates

Specifications, Features and Benefits

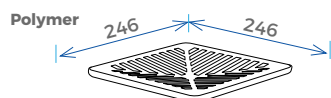

PIT GRATES

Sits on top of a Rainwater Pit or Flo-way Pit to allow water to drain into pit. Grates can be purchased complete with Flo-way Pit or separately for Rainwater Pit

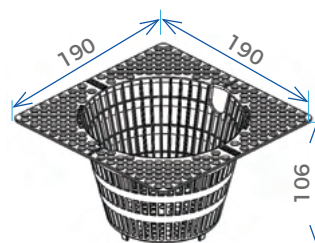
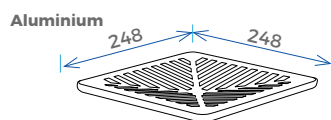

LEAF BASKET

Fits Rainwater Pit and assists flow of surface water by providing a barrier against leaves and other debris entering the waterways

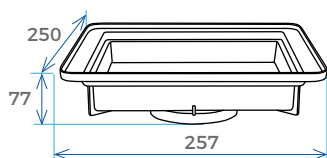

FLO-WAY PIT

Square trap design funnels rainwater directly into a connected stormwater pipe. Suits 90mm or 100mm PVC pipe

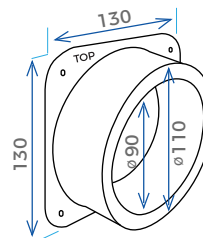

PIT BOSS

Creates a pipe connection to pits, reducing issues caused by subsidence of the ground or improper installation connections. Assists in maintaining the fall of the pipework into the pit

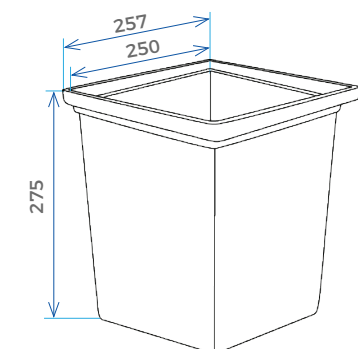

RAINWATER PIT

Designed as a drainage collection point by itself or for connection to the EasyDRAIN Channel and Grate system

Rainwater & Flo-way Grate Options

All grates are available on their own or as a complete unit with the Flo-way or Rainwater Pit. It is best to consider your application of where and how the pit will be used before selecting a grate to ensure it will be appropriate for the chosen application.

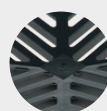

Black Polymer



Grey Polymer

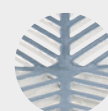

Aluminium

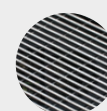

EURODESIGN 316
Stainless Steel

Note: All measurements are in millimetres. Dimensions may vary due to the nature of polymer

THE COMPLETE

SURFACE WATER DRAINAGE SYSTEM



The above imagery uses EasyDRAIN Standard and Rainwater Pits to show how they interact together. This is not a typical configuration that would be installed. EasyDRAIN Standard, Compact and Edge all interact with the Flo-way and Rainwater pits in similar configurations. The only product line this doesn't apply to is TechnoDRAIN & EvoMAX.

For more examples of drainage configurations please check everhard.com.au or email info@everhard.com.au

Are you a specifier? All of our products come with spec sheets found on our website. If you are after Revit files or additional information, contact us at marketing@everhard.com.au

EasyDRAIN
STANDARD

EasyDRAIN
COMPACT

EasyDRAIN
EDGE

TechnoDRAIN
& EvoMAX

Flo-way &
Rainwater

PRODUCT LIST

EasyDRAIN STANDARD

Product Description	EI Code	Length	Width	Height
1M Channel with Black Polymer Grate	83300	1000mm	138mm	137mm
3M Channel with Black Polymer Grate	83390	3000mm	138mm	137mm
Corner with Black Polymer Grate	83330	171mm	171mm	137mm
Tee Piece with Black Polymer Grate	83400	218mm	178mm	137mm
Slim Pit with Black Polymer Grate	83800	265mm	138mm	255mm
1M Channel with Pressed Galvanised Steel Grate	83432	1000mm	138mm	137mm
3M Channel with Pressed Galvanised Steel Grate	83433	3000mm	138mm	137mm
Corner with Pressed Galvanised Steel Grate	83338	171mm	171mm	137mm
Tee with Pressed Galvanised Steel Grate	83900	218mm	178mm	137mm
Slim Pit with Pressed Galvanised Steel Grate	83802	265mm	138mm	255mm
1M Channel with Pressed Stainless Steel Grate	83303	1000mm	138mm	137mm
3M Channel with Pressed Stainless Steel Grate	83393	3000mm	138mm	137mm
Corner with Pressed Stainless Steel Grate	83333	171mm	171mm	137mm
Tee with Pressed Stainless Steel Grate	83901	218mm	178mm	137mm
Slim Pit with Pressed Stainless Steel Grate	83801	265mm	138mm	255mm
1M Channel with Galvanised Round Bar Grate	83307	1000mm	138mm	137mm
1M Channel with EURODESIGN Stainless Steel Grate	83308	1000mm	138mm	137mm
1M Channel with EURODESIGN Stainless Steel A/V Grate	83309	1000mm	138mm	137mm
Corner with EURODESIGN Stainless Steel Grate	83335	171mm	171mm	137mm
Standard Black Polymer End Cap	83360		138mm	131mm
Standard Black Polymer Converter	83370		126mm	109mm
Standard Black Polymer Leaf Dome	84040		83mm	51mm

EasyDRAIN COMPACT

Product Description	EI Code	Length	Width	Height
1M Channel with Black Polymer Heel Friendly Grate	83500	1000mm	136mm	80mm
3M Channel with Black Polymer Heel Friendly Grate	83530	3000mm	136mm	80mm
Corner with Black Polymer Heel Friendly Grate	83600	175mm	175mm	80mm
Tee with Black Polymer Heel Friendly Grate	83550	203mm	170mm	80mm
Slim Pit with Black Polymer Heel Friendly Grate	83540	265mm	138mm	255mm
1M Channel with Pressed Galvanised Steel Grate	83501	1000mm	136mm	80mm
Corner with Pressed Galvanised Steel Grate	83601	175mm	175mm	80mm
Tee Piece with Pressed Galvanised Grate	83550G	203mm	170mm	80mm
Slim Pit with Pressed Galvanised Steel Grate	83540G	265mm	138mm	255mm
Compact Black Polymer End Cap	83700		130mm	51mm
Compact Black Polymer Converter	83701		130mm	46mm

PRODUCT VARIATION INFORMATION

EasyDRAIN Edge

Product Description	EI Code	Length	Width	Height
1M Channel with Edge Grate	83210	1000mm	138mm	142mm
Internal Corner & Grate	83220	171mm	138mm	146mm
External Corner & Grate	83225	171mm	138mm	146mm
Access Pit & Grate	83215	250mm	138mm	258mm
Heel Friendly Insert (4 pack)	83230	250mm	19mm	56mm

TechnoDRAIN & EvoMAX

Product Description	EI Code	Length	Width	Height
EvoMAX 150H 1M Channel with Galvanised Steel Grate	81471	1000mm	200mm	210mm
EvoMAX 200H 1M Channel with Galvanised Steel Grate	81503	1000mm	250mm	210mm
EvoMAX 200H 1M Channel with Galvanised Steel Heel Proof Grate	81504	1000mm	250mm	210mm
TechnoDRAIN 150H 1M Channel & Ductile Iron Grate	81423	1000mm	200mm	210mm
TechnoDRAIN 200H 1M Channel & Ductile Iron Grate	81380	1000mm	250mm	210mm
Technobox 200H Sump Drain with Ductile Iron Grate	81381	500mm	260mm	476mm
150H End Cap	81422	165mm	57mm	160mm
200H End Cap	81402	215mm	57mm	160mm
Sump Basket Filter 200	81433	495mm	255mm	20mm

Flo-way/ Rainwater Pits & Grates

Product Description	EI Code	Length	Width	Depth
Flo-way with Grey Polymer Grate	84756	257mm	257mm	77mm
Flo-way with Aluminium Polymer Grate	84762	257mm	257mm	77mm
Flo-way with EURODESIGN Stainless Steel Grate	84744	257mm	257mm	77mm
Flo-way with EURODESIGN Stainless Steel A/V Grate	84745	257mm	257mm	77mm
Rainwater Pit Case Only	84825	257mm	257mm	275mm
Rainwater Pit with Aluminium Grate	84768	257mm	257mm	275mm
Rainwater Pit with EURODESIGN Stainless Steel Grate	84777	257mm	257mm	275mm
Rainwater Pit with EURODESIGN Stainless Steel A/V Grate	84778	257mm	257mm	275mm
Flo-way/ Rainwater Black Polymer Grate Only	81010	246mm	246mm	20mm
Flo-way/ Rainwater Grey Polymer Grate Only	84830	246mm	246mm	20mm
Flo-way/ Rainwater Aluminium Grate Only	21330	248mm	248mm	20mm
Flo-way/ Rainwater EURODESIGN Stainless Steel Grate Only	97844	248mm	248mm	20mm
Flo-way/ Rainwater EURODESIGN Stainless Steel A/V Grate Only	97845	248mm	248mm	20mm



BRANCHES

Head Office

454 Newman Road
Geebung QLD 4034
(07) 3637 6444

Cairns

55 Supply Road
Bentley Park QLD 4869
(07) 4031 3558

Sydney

464 Victoria Street
Wetherill Park NSW 2164
(02) 8711 1111

Melbourne

11-13 Claredale Road
Dandenong VIC 3175
(03) 9771 7344

Perth

28 Haydock Street
Forrestdale WA 6112
(08) 9417 8222

AGENTS

Wholesale Products

2B Knoll Street
Glenorchy TAS 7010
(03) 6273 3455

Young's Distribution Centre

8 Whitehouse Street
Garbutt QLD 4814
(07) 4779 0222

RD Agencies SA & NT

Unit 5/8 Lindsay Road
Lonsdale SA 5160
(08) 8387 7344

For complete warranty information or standards applicable to any of our products, please contact 13 19 26 or email info@everhard.com.au. Visit everhard.com.au for the latest product updates, news and releases.

All measurements throughout this brochure are in millimetres and are solely for reference purposes. Any changes resulting from technical advance of design may be made without prior notice. Always refer to the physical product and instructions before installing. While every care has been exercised in compiling and publishing the information contained in these pages, Everhard accepts no responsibility for errors or omissions and all information is believed to be correct at the time of printing. Everhard reserves the right to delete or alter items without notice. Appliances are for display purposes only. Colours have been reproduced with as much accuracy as possible. Styles, sizes and colours may vary.

Everhard Industries Pty Ltd
ABN 41 009 690 859

November 2021 | Version 004