



FULL BOAR

DEMOLITION HAMMER

- *40 Joules*
- *1150min⁻¹*



INSTRUCTION MANUAL



WARNING: Read all safety warnings and all instructions. Failure to follow the warnings and instructions may result in electric shock, fire and/or serious injury. Save all warnings and instructions for future reference.

SPECIFICATIONS - MODEL NO. FBT-1200

Power:	1500W
Input:	230-240V ~ 50Hz
Impact Energy:	40 joule
Impact Rate:	1150min ⁻¹
Breaking Capacity:	200mm
Bit Fitment:	Hex
Weight (tool only):	14.2kg

KNOW YOUR PRODUCT

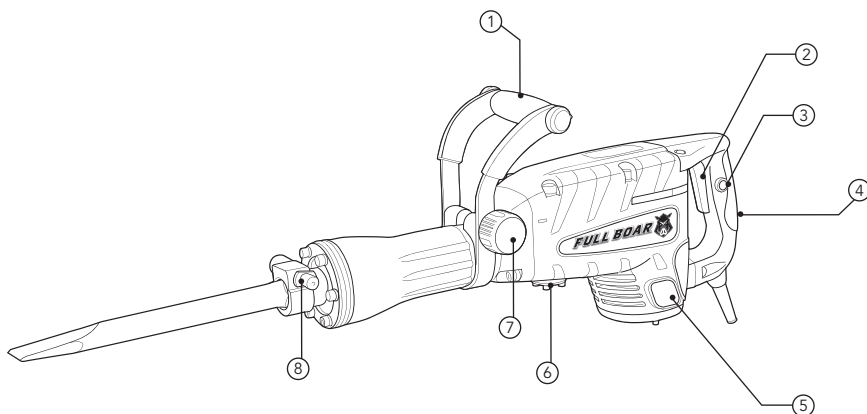

- | | |
|----------------------------------|---------------------------|
| 1. Front Handle (with soft grip) | 5. Carbon Brush Access |
| 2. On/Off Trigger | 6. Grease Cap |
| 3. Lock-on Button | 7. Handle Locking Knob |
| 4. Rear Handle (with soft grip) | 8. Quick Release Bit Lock |

TABLE OF CONTENTS

SPECIFICATIONS.....	Page 2
KNOW YOUR PRODUCT.....	Page 2
INTRODUCTION.....	Page 4
SAFETY INSTRUCTIONS.....	Page 4
ASSEMBLY.....	Page 8
OPERATION	Page 9
MAINTENANCE	Page 10
CONTENTS	Page 13
WARRANTY.....	Page 14

INTRODUCTION

Congratulations on purchasing a Full Boar Demolition Hammer. Your Full Boar Demolition Hammer FBT-1200 has been designed for rapid breaking and chipping of concrete, block and masonry products.

SAFETY INSTRUCTIONS



Warning! When using mains-powered equipment, basic safety precautions, including the following, should always be followed to reduce risk of fire, electric shock, personal injury and material damage.

Read and understand the manual prior to operating this tool.

Save these instructions and other documents supplied with this tool for future reference.

ELECTRICAL SAFETY

The electric motor has been designed for 230V and 240V only. Always check that the power supply corresponds to the voltage on the rating plate.

Note: The supply of 230V and 240V on Full Boar tools are interchangeable for Australia and New Zealand.

If the supply cord is damaged, it must be replaced by an electrician or a power tool repairer in order to avoid a hazard.

Using an Extension Lead

Always use an approved extension lead suitable for the power input of this tool. Before use, inspect the extension lead for signs of damage, wear and ageing. Replace the extension lead if damaged or defective.

When using an extension lead on a reel, always unwind the lead completely. Use of an extension lead not suitable for the power input of the tool or which is damaged or defective may result in a risk of fire and/or electric shock.

It is recommended that the extension lead is a maximum of 25m in length. Do Not use multiple extension leads.

GENERAL SAFETY INSTRUCTIONS



WARNING! Read all safety warnings and all instructions. Failure to follow the warnings and instructions may result in electric shock, fire and/or serious injury.

Save all warnings and instructions for future reference. The term “power tool” in the warnings refers to your mains-operated (corded) power tool or battery-operated (cordless) power tool.

1. Work area safety

- a. Keep work area clean and well lit.** Cluttered or dark areas invite accidents.
- b. Do not operate power tools in explosive atmospheres, such as in the presence of flammable liquids, gases or dust.** Power tools create sparks which may ignite the dust or fumes.
- c. Keep children and bystanders away while operating a power tool.** Distractions can cause you to lose control.

2. Electrical safety

- a. Power tool plugs must match the outlet. Never modify the plug in any way. Do not use any adapter plugs with earthed (grounded) power tools.** Unmodified plugs and matching outlets will reduce risk of electric shock.
- b. Avoid body contact with earthed or grounded surfaces, such as pipes, radiators, ranges and refrigerators.** There is an increased risk of electric shock if your body is earthed or grounded.
- c. Do not expose power tools to rain or wet conditions.** Water entering a power tool will increase the risk of electric shock.
- d. Do not abuse the cord. Never use the cord for carrying, pulling or unplugging the power tool. Keep cord away from heat, oil, sharp edges or moving parts.** Damaged or entangled cords increase the risk of electric shock.
- e. When operating a power tool outdoors, use an extension cord suitable for outdoor use.** Use of a cord suitable for outdoor use reduces the risk of electric shock.
- f. If operating a power tool in a damp location is unavoidable, use a residual current device (RCD) protected supply.** Use of an RCD reduces the risk of electric shock.

3. Personal safety

- a. Stay alert, watch what you are doing and use common sense when operating a power tool. Do not use a power tool while you are tired or under the influence of drugs, alcohol or medication.** A moment of inattention while operating power tools may result in serious personal injury.
- b. Use personal protective equipment. Always wear eye protection.** Protective equipment such as dust mask, non-skid safety shoes, hard hat, or hearing protection used for appropriate conditions will reduce personal injuries.
- c. Prevent unintentional starting. Ensure the switch is in the off-position before connecting to power source and/or battery pack, picking up or carrying the tool.** Carrying power tools with your finger on the switch or energising power tools that have the switch on invites accidents.

GENERAL SAFETY INSTRUCTIONS (cont.)

d. Remove any adjusting key or wrench before turning the power tool on. A wrench or a key left attached to a rotating part of the power tool may result in personal injury.

e. Do not overreach. Keep proper footing and balance at all times. This enables better control of the power tool in unexpected situations.

f. Dress properly. Do not wear loose clothing or jewellery. Keep your hair, clothing and gloves away from moving parts. Loose clothes, jewellery or long hair can be caught in moving parts.

g. If devices are provided for the connection of dust extraction and collection facilities, ensure these are connected and properly used. Use of dust collection can reduce dust-related hazards.

4. Power tool use and care

a. Do not force the power tool. Use the correct power tool for your application. The correct power tool will do the job better and safer at the rate for which it was designed.

b. Do not use the power tool if the switch does not turn it on and off. Any power tool that cannot be controlled with the switch is dangerous and must be repaired.

c. Disconnect the plug from the power source and/or the battery pack from the power tool before making any adjustments, changing accessories, or storing power tools. Such preventive safety measures reduce the risk of starting the power tool accidentally.

d. Store idle power tools out of the reach of children and do not allow persons unfamiliar with the power tool or these instructions to operate the power tool. Power tools are dangerous in the hands of untrained users.

e. Maintain power tools. Check for misalignment or binding of moving parts, breakage of parts and any other condition that may affect the power tool's operation. If damaged, have the power tool repaired before use. Many accidents are caused by poorly maintained power tools.

f. Keep cutting tools sharp and clean. Properly maintained cutting tools with sharp cutting edges are less likely to bind and are easier to control.

g. Use the power tool, accessories and tool bits etc. in accordance with these instructions, taking into account the working conditions and the work to be performed. Use of the power tool for operations different from those intended could result in a hazardous situation.

5. Service

a. Have your power tool serviced by a qualified repair person using only identical replacement parts. This will ensure that the safety of the power tool is maintained.

b. If the supply cord of this power tool is damaged, it must be replaced by a specially prepared cord available through the service organization.

ADDITIONAL SAFETY RULES FOR DEMOLITION HAMMERS

- **Wear ear protectors.** Exposure to noise can cause hearing loss.
- **Use auxiliary handle(s), if supplied with the tool.** Loss of control can cause personal injury.
- **Hold power tool by insulated gripping surfaces, when performing an operation where the cutting accessory may contact hidden wiring or its own cord.** Cutting accessory contacting a “live” wire may make exposed metal parts of the power tool “live” and could give the operator an electric shock.

 **WARNING!** This appliance is not intended for use by persons (including children) with reduced physical, sensory or mental capabilities, or lack of experience and knowledge, unless they have been given supervision or instruction concerning use of the appliance by a person responsible for their safety.

Recommendations for the use of a residual current device with a rated residual current of 30mA or less.

- Always use an approved extension lead suitable for the power input of this tool. Before use, inspect the extension lead for signs of damage, wear and ageing. Replace the extension lead if damaged or defective.
- When using an extension lead on a reel, always unwind the lead completely. Use of an extension lead not suitable for the power input of the tool or which is damaged or defective may result in a risk of fire and electric shock.
- It is recommended that the extension lead is a maximum of 25m in length. Do Not use multiple extension leads.
- Before drilling into walls, ceilings etc, ensure there are no concealed power cables or pipes in the cavity.
- Always use the side handle, this gives you greater control if the accessory should become jammed.
- Keep the cord clear of the accessory being used, do not wrap the cord around your arm or wrist.
- Hold the tool by the insulated gripping surfaces when performing an operation where the accessory may contact hidden wiring or its own cord.
- Use thick cushioned gloves and limit the exposure time by taking frequent breaks.
- Vibration caused by the hammer action may be harmful to your hands and arms.
- When removing an accessory from the tool avoid contact with skin and use proper protective gloves when grasping the bit or accessory. Accessories may be hot after prolonged use.

 **WARNING!** Some dust created by power sanding, sawing, grinding, drilling and other construction activities contain chemicals known to cause cancer, birth defects or other reproductive harm.

Some examples of these chemicals are:

- Lead from lead-based paints;
- Crystalline silica from bricks, cement and other masonry products, and;
- Arsenic and chromium from chemically-treated timber.

The risk from such exposures vary depending on how often you do this type of work. To reduce your exposure to these chemicals; work in a well ventilated area, and work with approved safety equipment, such as those dust masks that are specifically designed to filter out microscopic particles.

Always wear eye protection and a dust mask for dusty applications and when drilling/chiselling overhead. Sanding particles can be absorbed by your eyes and inhaled easily and may cause health complications.

ASSEMBLY

WARNING! BEFORE ATTACHING OR REMOVING ANY ACCESSORIES, BE SURE TO DISCONNECT THE DEMOLITION HAMMER FROM THE POWER SUPPLY

Adjusting the Front Handle

The front handle (1) is adjustable to any position around the 360° handle collar mount.

1. Rotate the front handle (1) around the collar mount to the desired position.
2. Tighten the accessory locking knob (7) by turning clockwise to secure the handle into place.

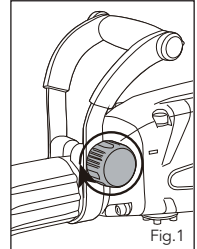

Fitting and Removing Accessories

Important! Always lubricate the accessory fitment prior to inserting them into the demolition hammer. Using your finger, apply grease sparingly to the shaft of the accessory from the supplied tub of grease. Lubricating the accessories will prolong the life of your demolition hammer. Non-lubrication of accessories will void your warranty.



Note: Prior to fitting an accessory, remove any dust or debris from the shank of the accessory.

1. Pull out the quick release bit lock (8) and rotate it 180°.

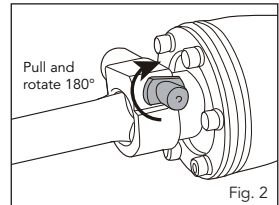

2. Insert the shank of the accessory into the nose of the tool. Ensure the notch on the shank is positioned as per the illustration shown. The notch in the shank of the accessory has to face the flat of the accessory holder as illustrated. If the notch is in an incorrect position, the shank will not lock into position.

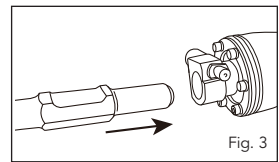

3. Lock the shank into the nose of the tool by pulling out the quick release bit lock (8) and rotating it 180°.
4. Pull on the accessory to ensure it is properly secured.

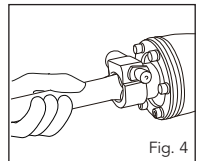

Note: The accessories will have a small amount (approx. 10-12mm) of back and forth movement from the accessory holder, this is normal.

Note: To avoid damage to the quick release bit lock (8), only use round hex shank bits. Damage caused to the bit lock (8) by using incorrect accessories will not be covered under warranty.

Warning! Accessories can be hot after use, always wear gloves to prevent burns or lacerations.

OPERATION

On/Off Switch

To turn the demolition hammer on, squeeze the On/Off Trigger (2). To turn the demolition hammer off, release the On/Off Trigger (2).

Lock-on Button

To lock the On/Off Trigger (2) in the on position that the demolition hammer continually works, squeeze the On/Off Trigger (2) and then press the Lock-On Button (3). Take pressure off the On/Off Trigger (2) before releasing the Lock-on Button (3).

Note: Always wait until the accessory has stopped moving before putting down the demolition hammer.

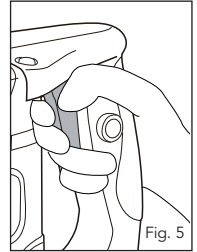

Cold Hammering

If the demolition hammer is stored for long periods of time or at cold temperatures, the lubrication may become stiff and the demolition hammer may not hammer initially or the hammering may be weak.

Should this occur, insert an accessory into the demolition hammer, turn the demolition hammer on and apply the end of the accessory against a scrap piece of concrete or timber. Turn the demolition hammer on and off every few seconds. After 15 seconds to 2 minutes, the demolition hammer should have started to hammer normally. The colder the demolition hammer, the longer it may take to warm up and function like normal.

Note: Always wait until the accessory has stopped moving before putting down the demolition hammer.

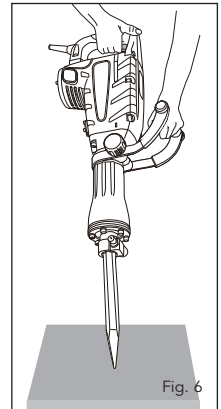

Operating the Demolition Hammer

For the best penetration rates in concrete, run the demolition hammer with a steady pressure, but do not use excessive force as this will decrease the efficiency of the demolition hammer.

Do not use the flat chisel as a "pry bar". Using the flat chisel for prying or pushing debris away from your work area will damage the flat chisel and potentially cause damage to your demolition hammer. Such damage will void your warranty.

MAINTENANCE

- Keep the ventilation vents of the demolition hammer clean at all times, if possible, prevent foreign matter from entering the vents.
- After each use, blow air through the demolition hammer housing to ensure it is free from all dust particles which may build up. Build up of dust particles may cause the demolition hammer to overheat and fail.
- If the enclosure of the demolition hammer requires cleaning, do not use solvents, but a moist soft cloth only. Never let any liquid get inside the demolition hammer; never immerse any part of the demolition hammer into a liquid.

Carbon brushes

When the carbon brushes wear out, the demolition hammer will spark and/or stop. Discontinue use as soon as this happens. They should be replaced prior to recommencing use of the demolition hammer. Carbon brushes are a wearing component of the demolition hammer, therefore not covered under warranty. Continuing to use the demolition hammer when the carbon brushes need to be replaced may cause permanent damage to the demolition hammer. Carbon brushes will wear out after many uses but when the carbon brushes need to be replaced, take the demolition hammer to an electrician or a power tool repairer for a quick and low cost replacement. Always replace both carbon brushes at the same time.

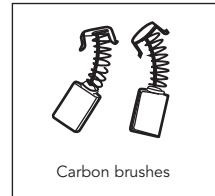

Gear Box Grease Replenishment

The grease in the gearbox will require replenishment after approximately 50 hours of accumulative use. After this time, add approximately 30 / 50 grams (approx 2-3 teaspoons) from the supplied tub of grease into the gearbox.

First remove the grease cap (6) from the demolition hammer by using the allen key to loosen all four bolts. Once removed, add the grease through this hole. Ensure the grease cap (6) is secured back into position with all four bolts properly fastened prior to operation.

Note: Ozito Industries will not be responsible for any damage or injuries caused by the repair of the demolition hammer by an unauthorised person or by mishandling of the demolition hammer.

Re-sharpening the chiselling tools

Good results are only achieved with sharp chisels, therefore sharpen the chiselling accessories regularly. This prolongs the service life of the tools and ensures good working performance.

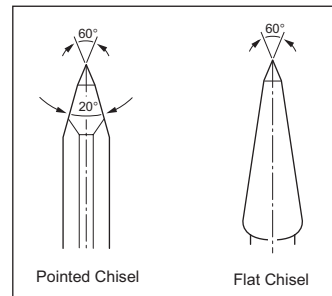

Sharpen chiselling tools using grinding wheels (e. g., ceramic bonded corundum wheel) with a steady supply of water. Recommended values for this purpose are shown below. Take care that no annealing coloration appears on the cutting edges, otherwise the hardness of the chiselling tools will be impaired



TROUBLE SHOOTING

Symptom	Solution
Accessory is falling out	Ensure that the accessory locking bolt has been rotated to the correct position.
Not chiseling or low breaking power	Tool temperature low Accessories not lubricated Refer to insert or Cold Hammering section for instructions on how to resolve this issue
Accessory is jammed/ stuck in concrete during use	Release the accessory locking mechanism, allowing the demolition breaker to be separated from the accessory. The accessory should be easily removed from concrete once it is detached from the demolition breaker.
Accessory repeatedly becomes stuck while in use	Free the accessory as described above. Refrain from penetrating too deeply with the chisel bit, as it is prone to becoming stuck when demolishing large pieces of concrete.
A small amount of sparking is visible through the housing air vents	This is normal and does not indicate a problem
Excessive sparking is visible through the housing air vents and/or the demolition breaker is failing to operate	This may indicate the carbon brushes have worn out and need to be replaced. Carbon brushes should only be replaced by a qualified electrician or power tool repairer.

DESCRIPTION OF SYMBOLS

V	Volts	Hz	Hertz
~	Alternating current	W	Watts
/min	Revolutions or reciprocation per minute	n_o	No load speed
∅	Diameter	dB	Decibel level
	Double insulated		Regulator compliance mark
/bpm	Impact rate		Warning

CARING FOR THE ENVIRONMENT



Power tools that are no longer usable should not be disposed of with household waste but in an environmentally friendly way. Please recycle where facilities exist. Check with your local council authority for recycling advice.



Recycling packaging reduces the need for landfill and raw materials. Reuse of recycled material decreases pollution in the environment. Please recycle packaging where facilities exist. Check with your local council authority for recycling advice.

CONTENTS

1 x FBT-1200 Demolition Hammer
1 x Pointed chisel
1 x Flat chisel
1 x Grease pot

1 x Allen key
1 x Carry case
1 x Side handle (fitted)

Distributed by:
Ozito Industries Pty Ltd

AUSTRALIA (Head Office)

1-23 Letcon Drive, Bangholme Victoria, Australia, 3175

Telephone: 1800 069 486

WARRANTY

YOUR WARRANTY FORM SHOULD BE RETAINED BY YOU AT ALL TIMES. IN ORDER TO MAKE A CLAIM UNDER THIS WARRANTY YOU MUST RETURN THE PRODUCT TO YOUR NEAREST BUNNINGS WAREHOUSE (see www.bunnings.com.au or www.bunnings.co.nz for store locations) WITH YOUR BUNNINGS REGISTER RECEIPT. PRIOR TO RETURNING YOUR PRODUCT FOR WARRANTY PLEASE TELEPHONE OUR CUSTOMER SERVICE HELPLINE:

**Australia 1800 069 486
New Zealand 0508 069 486**

TO ENSURE A SPEEDY RESPONSE PLEASE HAVE THE MODEL NUMBER AND DATE OF PURCHASE AVAILABLE. A CUSTOMER SERVICE REPRESENTATIVE WILL TAKE YOUR CALL AND ANSWER ANY QUESTIONS YOU MAY HAVE RELATING TO THE WARRANTY POLICY OR PROCEDURE.

1 YEAR WARRANTY

Your product is guaranteed for a period of **12 months from the original date of purchase**. If a product is defective it will be repaired in accordance with the terms of this warranty. Warranty excludes consumable parts, for example: wheels, bearings.

The benefits provided under this warranty are in addition to other rights and remedies which are available to you under law. The warranty covers manufacturer defects in materials, workmanship and finish under normal use.

Our goods come with guarantees that cannot be excluded under Australian Consumer law & Consumer Guarantees Act 1993 (NZ). You are entitled to a replacement or refund for a major failure and to compensation for other reasonably foreseeable loss or damage. You are also entitled to have the goods repaired and replaced if the goods fail to be of acceptable quality and the failure does not amount to a major failure.

WARRANTY EXCLUSIONS

The following actions will result in the warranty being void.

- If the tool has been operated on a supply voltage other than that specified on the tool.
- If the tool shows signs of damage or defects caused by or resulting from abuse, accidents or alterations.
- Failure to perform maintenance as set out within the instruction manual.
- If the tool is disassembled or tampered with in any way.
- The warranty excludes damage resulting from product misuse or product neglect.

This warranty is given by Ozito Industries Pty Ltd.

ABN: 17 050 731 756

Ph.1800 069 486

Australia/New Zealand (Head Office)
1-23 Letcon Drive, Bangholme, Victoria, Australia 3175