

ESTILO®

CARE HEIGHT LINK SUITE PLUMBERS INSTALLATION GUIDE

This Product is to be installed by a licensed Plumber

1. Check that this toilet is compatible with your current set out requirements.
S-Trap 140-300mm
2. Before installing your new toilet please make sure you have received all items and that they are undamaged. Any damage claims after installation will not be accepted.
3. Check that the floor and wall are level and perpendicular.

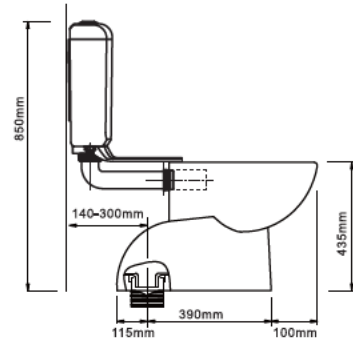

Installation

1. Floor Fixing Kit – measure and install the floor fixing kit (see instructions in kit) don't install the external locking SS screws at this stage.

2.

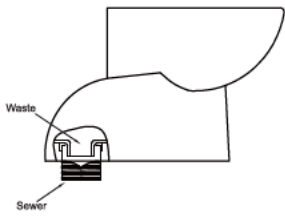

Connect the waste to the sewer, ensure that the sewer connection is connected correctly and that a good seal has been achieved.

3.

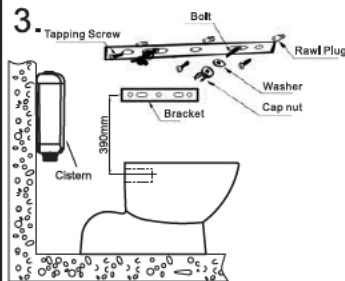

Hang the bracket on the wall. Note – Take caution when selecting the area to be drilled as water pipes or other hazardous objects may be present in wall. Install the cistern.

4.

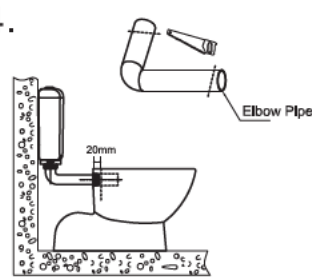

Cut the elbow pipe to size before connecting it to the WC pan connector. Note – Use a fine tooth hand saw/hacksaw to make the cut, ensure there is a 20mm minimum connection into the pan.

5.

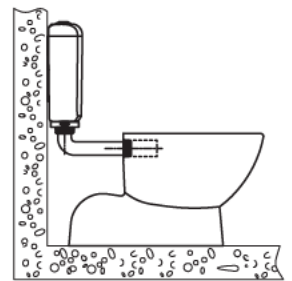

Securely connect the WC pan with the elbow pipe.

6.

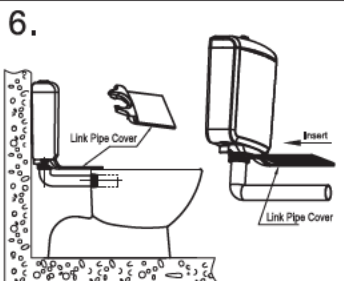

Install the link pipe cover on the cistern.

7.

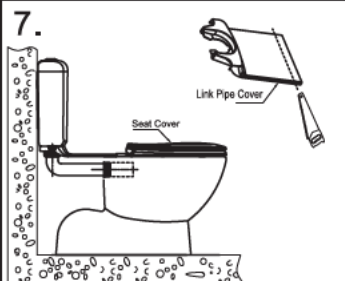

Measure and mark the area to be cut from the link pipe cover by loosely installing the toilet seat into the pan. Remove both items and make the cut with a fine tooth hand saw/hacksaw. Note – Use the cut lines on the back of the link pipe cover to ensure you achieve a straight cut. Reinstall the link pipe cover.

8. Before fixing this toilet to the floor, connect the water supply and ensure that the toilet is working correctly by doing several flush tests. Check for leaks. Once you are confident that there are no leaks and the toilet is working correctly install the Pan into the Floor Fixing Kit provided and apply a bead of Wet Area Silicone under the base of the Pan (you will need to allow recommended drying time before use).

9.

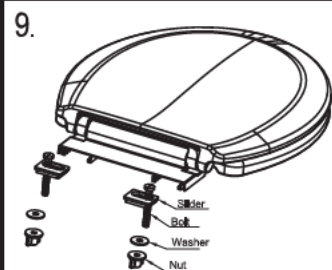

Install the seat after the silicone has dried.