

easycraft
Installation Guide
Wall & ceiling linings





Australian Made

All our raw materials are produced by Australian manufacturers, our processing and painting is conducted locally. Easycraft has a national sales & distribution network to ensure that our products can be provided to any renovation, extension, residential or commercial construction site throughout Australia.



Quality

Easycraft panels provide the natural feel of timber without the defects, imperfections, knots and grain inconsistencies.

Easycraft panels are manufactured with a consistent density, thickness, width and length, and are suitable for use with fixing nails and countersunk screws. The panels can be loaded with significantly more weight than plasterboard.



Tough and Impact Resistant

Easycraft panels are 300% more impact resistant than standard plasterboard and 50% better than impact resistant plasterboard which makes Easycraft panels an ideal choice for corridors, foyers, high traffic areas of Education, Retail, Office and Aged Care & Health Care facilities. Refer Impact Test - Easycraft verses Plasterboard video on website. Out performs by up to 3 times.



Ease of Installation

Easycraft's easyjoin system provides a means to join one board to the next easily and seamlessly. The easyjoin system allows you to install your selected profile with no sign of interruption. Easycraft panels are easy to install, so much so that we have significant popularity among DIY home improvers.

Within commercial projects, it can be installed by one of the following contractors; Carpenter, Plastering Contractor or Joinery Contractor.

accreditations



Easycraft is committed to sourcing and using the best available environmentally sustainable timber for use in our wall & ceiling products and as such operates an AS 4707:2014 – Chain of Custody compliant management system for certified wood and forest products. Our core suppliers operate under the same Standard and have Chain of Custody Accreditation.

The Australian Standard is part of the Australian Forestry Certification Scheme which is endorsed by the Programme for the Endorsement of Forest Certification, in accordance with the PEFC International Standard – PEFC ST 2002:2013, Chain of Custody of Forest Based Products.



Building Code of Australia

Easycraft comply with Impact, Thermal, Acoustic & Fire requirements of the National Construction Code. Easycraft has formally tested their products and have available tests results.



Greenfirst

Global GreenTag certified products pass the world's toughest standards to protect you, and your family's health and safety, minimise your impact on our finite planet and put the power of selection back in your hands



Wood Naturally

Easycraft is a proud promoter of the benefits of using wood based products, not only from an environmental perspective but also for the use, look, feel and additional hard wearing benefits.

contents

general product	2
product type & application	3
easyjoin system	3
installation essentials	4
tools & equipment	5
fixing to timber or steel frames	6
fixing dado panels to timber or steel frames	7
fixing horizontally to timber or steel frames	7
fixing easyascot to timber or steel frames	8
fixing to existing wall	9
fixing to brick & block walls	10
fixing to ceiling	11
fixing to interior wet area	12
finishing options - mouldings	14
easycraft finishing dado rails	14
wall to floor finishing options	15
ceiling finishing options	16
finishing - paint	17
finishing - lacquer/stain	18
grooved panel curvature	19
fireplace installation	19
material references	20
easycraft design partners	20
limitations	21
manufacturers warranty	21
continuous improvement	21

Front Cover Image
Project styled by Kristy Spencer, Bare Studio.
Product featured - easyVJ100.

Back Cover Image
Project styled by Salt Shoal Bay.
Product featured - easyVJ100 ceiling.

contact us

If you require any further support for your Project or Specification, please contact Easycraft National Office, to be transferred to your Regional Sales Manager.

National Office & Manufacturing

140 North Road Wynnum West QLD 4178

Postal Address:

PO. Box 3496
Tingalpa DC QLD 4173

Phone:

Brisbane: 07 3906 7200

For Other States contact details call Brisbane Office.

Email:

marketing@easycraft.com.au

general product

Information

The following installation instructions and guides are in addition to local and state regulations and the requirements of the National Construction Code (NCC).

All diagrams in this installation guide are for demonstration purposes only.

Diagrams may omit some components for clarity.

Deviation from standard applications and requirements detailed in this installation Manual or supplementary

EasyCraft Construction details may void the manufacturer's product warranty.

Storage

The following recommendations should be applied to maintain EasyCraft panels in good order and condition. The storage area should be protected from the sun, rain and wind.

Product should be stored flat, undercover and on timber bearers spaced at maximum 600mm centres.

Never store material outdoors or in an open area (verandah) or areas with newly poured concrete or in rooms that have been recently plastered.

Panel dimensions & joining

Please note, presented board & profile dimensions are nominal sizes and are subject to manufacturing variance.

Please check all panels on deliver to pre-plan installation based on sizing received.

When end-joining wall and ceiling panels profiles may not align exactly, so we recommend a moulding be placed over the join to minimise any variance.

Pre-conditioning

Pre-conditioning MDF panels is recommended so they attain an equilibrium moisture content (EMC) before fixing, so as to reduce the likelihood of bowing or shrinkage after they have been fixed.

Some boards may achieve an EMC simply by being stored for some time in the location where they are to be used without any positive conditioning.

We recommend product should be delivered to site minimum 48 hours prior to installation and stored in the environment of where it is to be installed to allow to acclimatise.

Cutting & working

EasyCraft products are easy to cut and shape with a normal hand or power saw. The normal health and safety precautions should be taken when working with wood panel products. Machining equipment should be fitted with dust collection devices and used in well ventilated areas.

Follow good hygienic and housekeeping practices. Wood dust can be vacuumed, shovelled or swept to avoid accumulation. If dust levels exceed Safe Work Australia Standards the wearing of a dust mask (AS 1715 and AS 1716) and safety glasses (AS 1337) is recommended.

Storage and work areas should be adequately ventilated.

Base material

As with solid wood, MDF is a hygroscopic material (meaning it readily takes up and retains moisture), thus its moisture content depends on the relative humidity and air temperature in the surrounding environment. As the moisture content of MDF changes, it is subject to dimensional changes.

There are many variables which can ultimately affect the performance of timber, including the surrounding environment, quality of installation and quality of framing.

But managing changes in the environment humidity levels and moisture content plays a very important role in achieving the best results from the product.

In environments that can experience large changes in air temperature and humidity you may experience movement in the panels, either expansion or shrinkage.

Maintenance

The extent and nature of maintenance will depend on the environment and exposure of the installed panels. EasyCraft products may be periodically cleaned with a damp cloth. Do not use high pressure washers, abrasive materials or cleaning products as this can cause coating damage and water ingress into the wall cavity.

Wet Areas

EasyCraft Interior Wet Area Panels are designed for high moisture environments but are not deemed "Water Resistant" by the NCC, meaning they are not suitable in the shower recess, or as a splash back "where the vessel is within 75mm of the wall". Panels can installed to stud frame, or directly to suitable plasterboard and fibre cement wall linings.

Safety

EasyCraft products are manufactured from wood products. Accordingly, machine tools should be fitted with dust extractors and operators should wear a dust mask and eye protection.

Further information is contained in the respective product Material safety Data Sheets (MSDS) available on our web site.

product type & application



Designed for interior walls and ceilings in a range of decorative profiles.

Suitable for:

- A replacement for traditional plasterboard or to cover existing wall finishes.
- Residential applications: Dining, kitchen, lounge, family, bedroom, study, media, games.
- Commercial applications: Foyers, classrooms, offices, rental properties, retail, restaurants, apartments, hotels, aged care facilities.



A ultra-high moisture resistant board that is offered in a range of decorative profiles. Allows seamless flow from living rooms to wet areas.

Suitable for:

- Use in areas subject to high moisture and humidity for walls & ceiling linings.
- Residential applications: Bathroom, laundry, kitchen, basement, garage, storeroom.
- Commercial applications: Offices, rental properties, restaurants, apartments, hotels, hospitals, aged care.

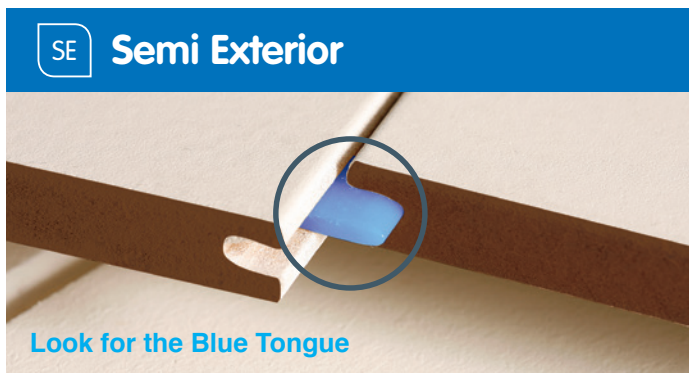

The perfect product for outdoor-undercover use. This pressed hardwood lining comes pre-primed and ready to paint.

Suitable for:

- Use in semi exterior undercover areas for walls & ceiling linings.
- Residential applications: Alfresco, patio, outdoor rooms, bbq areas.
- Commercial applications: Toilet blocks, outdoor kitchens, laundries, garages, storage units.



A Fire Rated interior board that delivers on performance and style. This product offers excellent fire-retardant properties in a large range of decorative profiles.

Suitable for:

- A range of applications where reduced fire reaction, flame spread and smoke development are critical.
- Specified commercial applications: Foyers, classrooms, offices, rental properties, retail, restaurants, apartments, hotels, aged care facilities, referenced against the NCC wall and ceiling lining material group requirements.

easyjoin system

Easycraft panels feature the easyjoin system that allows for a fuss free, quick installation.

The panels are identified by a Green Tongue for general purpose interior, a Blue Tongue for wet area interior & semi-exterior applications and a Red Tongue for Fire Rated interior applications.

GP general purpose interior

- Product should be delivered to site a minimum 48 hours prior to installation and stored in the environment of where it is to be installed to allow it to acclimatise.
- The framing must be straight and true.
- For Wall & Ceiling applications framing can be placed at 600mm centres or less. We recommend for ceilings, framing placed at 450mm.
- Easycraft linings can be joined off the studs but these joins must be supported by additional noggins at 700mm maximum spacing.
- Fixings should be positioned no closer than 25mm to a corner and no closer than 15mm to the edge. This positioning will prevent splintering and breakout.
- A 10mm gap must be left at the floor if the wall lining is being installed only part way up the wall.
- A 5mm gap must be left at the top and bottom of the sheet if the wall lining is being installed from floor to ceiling.
- A 0.5mm expansion gap should be allowed at each join. Do not 'Hard Knock' the panels together.
- For each metre width of wall or ceiling, allow approx. 1.0mm for an expansion gap at the outer perimeters of your wall or ceiling. (e.g. 6m wall x 1.0mm = 6mm therefore leave a 3mm gap at each outer edge of wall or ceiling)
- Decide how you wish to finish off internal and external corners before you install the first sheet.
- We recommend for horizontal and ceiling applications that you DO NOT END BUTT sheets due to the potential for movement.

WA wet area interior SE semi-exterior

Interior linings cannot be used in direct 'wet areas', such as showers or as splashback (where the vessel is within 75mm of the wall). Easycraft WET AREA

Interior linings can line all other areas including ceilings within bathrooms and laundries (in accordance with AS 3740 and NCC Volume One, F1.7 and Volume Two, 3.8.1)

- We recommend for all internal high moisture or humidity household areas to use our Wet area interior product as the base substrate.
- Easycraft recommends that Australian Standard, "Waterproofing in Wet Areas within Residential Buildings", AS3740 - 2010 be consulted in conjunction with these instructions before Easycraft Wall Linings are installed in bathrooms.
- Under no circumstances should Easycraft Wall Linings be installed in direct wet areas as defined by AS3740 -2010 e.g. shower recesses & splashbacks
- Easycraft Wall Linings can be installed on internal partition walls in bathrooms.
- Easycraft Wall Linings can be installed on internal bathroom walls that back onto an external wall.
- When installing above the shower Easycraft Wall Linings must not be installed lower than 1800mm from the finished floor level as per NCC requirement.
- When installing above a bath tub, Easycraft Wall Linings must be installed at a minimum of 150mm above the vessel for the length of the vessel (as per NCC requirements).
- When installing above a bath with a shower over the bath Easycraft Wall Linings must be installed no closer than 1500mm from the wall carrying the fixed shower rose.
- When installing wet area panels adjacent to an enclosed shower, the junction must be fully waterproofed, and the panel protected as it is not a water proof material.

Semi-Exterior linings can be used for semi- exterior undercover areas – such as walls, ceilings and eave linings.

tools & equipment

Tools and Equipment

- Tape Measure
- Hand Saw or Power Saw
- Hammer / Nail Gun or Screw Gun
- Pencil
- Spirit Level
- String Line
- Caulking Cartridge Gun or Spatula
- P1 or P2 Dust Mask
- Safety Glasses (complying with AS1337)

Cutting:

EasyCraft Wall Linings can be easily cut with a Power Saw or Hand Saw. When using a Power Saw, cut the board with the face side down. When using a Hand Saw, cut the board with the face side up.

Fixing:

If fixing with power tools ensure the driving pressure is only sufficient to drive the head marginally below the surface. If the driving pressure is too high and the nail is driven in too far, splitting of the board could occur and tool marks will show.

Please refer to our website, Help Centre for more detailed product and installation information.

Consumables

The following is a list of products that are suggested will perform in typical product applications.

- Use recommended Nails & Screws. Nails and Screws are to be long enough to penetrate the studs at least 25-30mm.
- A flexible construction adhesive is to be used to glue the sheets to the frame/Studs and noggins.
- The adhesive selected should allow for movement to take place.
- PVA adhesive is for gluing corners together and supporting the fixing of mouldings in place
- **Nails**
Must be long enough to penetrate the studs at least 30mm.

Fixing wall linings:

- Hammer – use 2mm x 40mm anti-rust bullet head nail
- Nail Gun – use Paslode ND Brads 14ga x 45mm

Fixing ceiling linings:

- Nail Gun – use Paslode Duo-Fast C2.5 x 45 Ring Shank

- **Screws**

Fixing into timber frame:

ICCONS: Needle point CSK head part No. TP796)

- 8 -15 x 20 or 30mm ICCONS: Collated
- Needle point CSK head collated (IC Find # 796C or 798C)
- 8 -15 x 20 or 30mm

Fixing into steel frame:

ICCONS: Self-Drilling CSK head Self embed head (part No. TP326)

- 8 -18 x 20 or 30mm ICCONS: Collated
- Self-Drilling CSK head Self embed head collated (IC Find # 344C or 346C)
- 8 -15 x 20 or 30mm

- **Glues**

A flexible construction adhesive or stud adhesive should be used for fixing the sheets to the studs and noggins.

- **Sealants/ Gap Filler**

For the best result, a flexible (25% movement capability) paintable sealant must be used when fixing skirtings, cornices and timber mouldings to EasyCraft Products. EasyCraft recommends FulaSeal 720 and SikaflexPro+.

- **Miscellaneous**

- Spacers – use off cuts of the 9mm MDF or 10mm timber pieces.
- PVA adhesive for gluing corners together and mouldings in place.
- Best to use a Timber based filler to fill nail or screw holes.

Wet Area Paint Finishes

Paint Manufacturers' may not offer a warranty when applying their paint product onto another manufacturer's base primer.

We recommend you trial the application of the final paint coat onto our primer prior to installation and your final application.

Products can be ordered as a raw, un-primed product to allow you to apply both the base primer and final coat from the paint manufacturer of your choice.

fixing to timber or steel frames

Step 1 - Preparing the frame

1. Studs must be spaced at no more than 600mm centres.
2. For commercial high traffic areas, we recommend 450 centres.
3. Where sheets are joined between studs place a noggin at 650-700mm to support the joint.
4. When sheets are part way up the wall place a noggin at the top to support the top edge.
5. Check that frames are straight and true. Fix any irregularities.
6. Refer to the Drawings below for frame layout.

Step 2 - Installing the sheets

1. Start from one corner of the room.
2. When installing Easycraft sheets over stud walls apply generous dollops of flexible stud adhesive at 300mm intervals on each stud and each noggin behind the first panel. Follow the adhesive manufacturer's recommendations for how much to use.
3. Place a 9mm or 10mm piece of timber or off cut of MDF under the bottom edge of the sheet, to raise it off the floor. You must allow a 9mm or 10mm gap at the bottom and/or top of all sheets.
4. Place the first sheet on the wall.

5. Check the sheet is plum (vertical) using a spirit level and fix the sheet using nails.
6. Space the nails approximately 200-300mm apart, fixing the sheet to the studs and noggins. Ensuring glue and fixings remain a suitable distance apart.
7. Fix nails/screws 50mm from the side at more than 10mm from the top and/or bottom of the panel.
8. Fix the panel starting from one edge
9. Remove the spacer from the bottom of the sheet.
10. Fix the other sheets using the same method outlined above, working along the wall from the first sheet.
11. Make sure you leave a 1.0mm to 1.5mm gap at each join to allow for expansion of the sheets. Do not hard knock panels together.
12. When you get close to the corner or a doorway, measure the gap from the fixed sheet to the corner and cut the next sheet so that it fits the remaining space. Fix the sheet using the same method as described above.
13. When all the sheets are fixed fit skirtings and architraves and finish off internal and external corners.
14. For the best result, a flexible (25% movement capability) paintable sealant must be used when fixing skirtings, cornices and timber mouldings to Easycraft Products. Easycraft recommends FulaSeal 720 and SikaflexPro+.

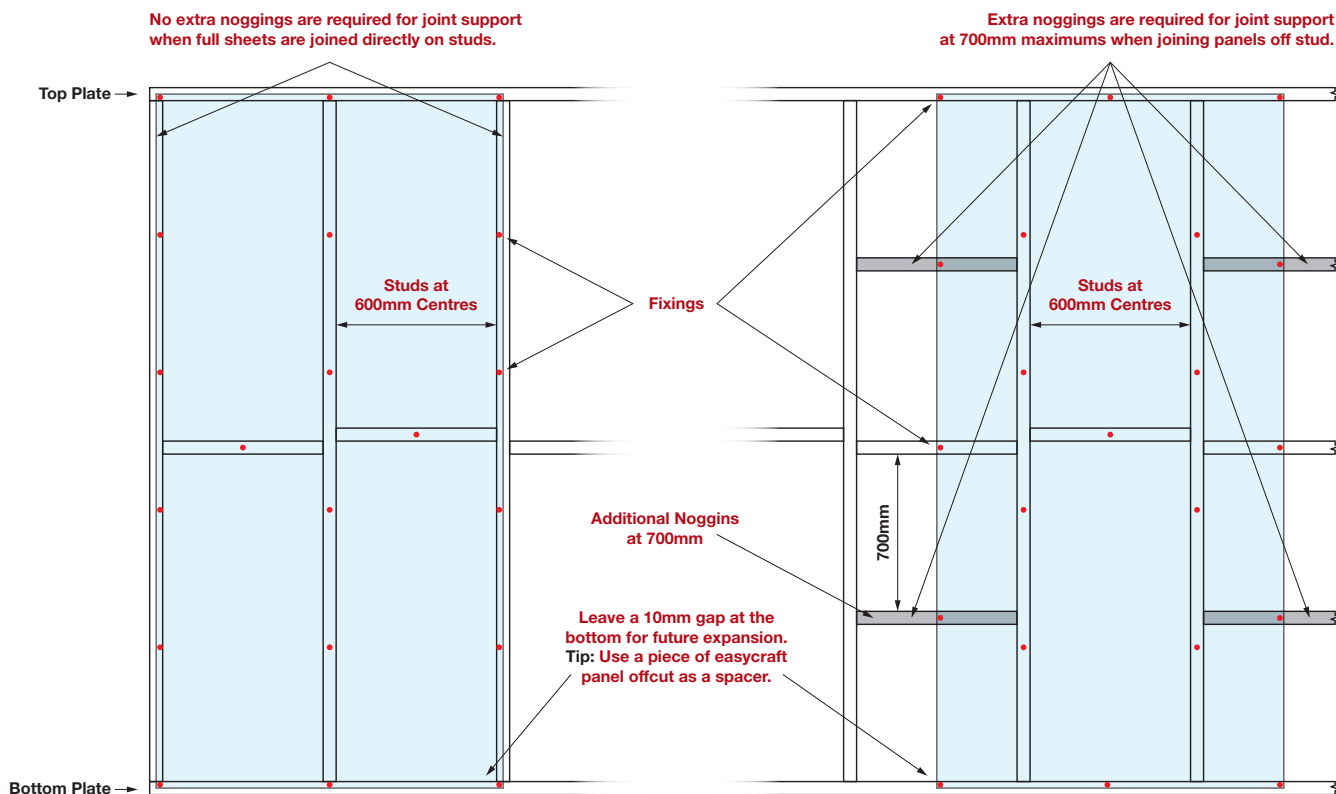

fixing dado panels to timber or steel frames

Half Height - 900mm and 1200mm Tall Panels

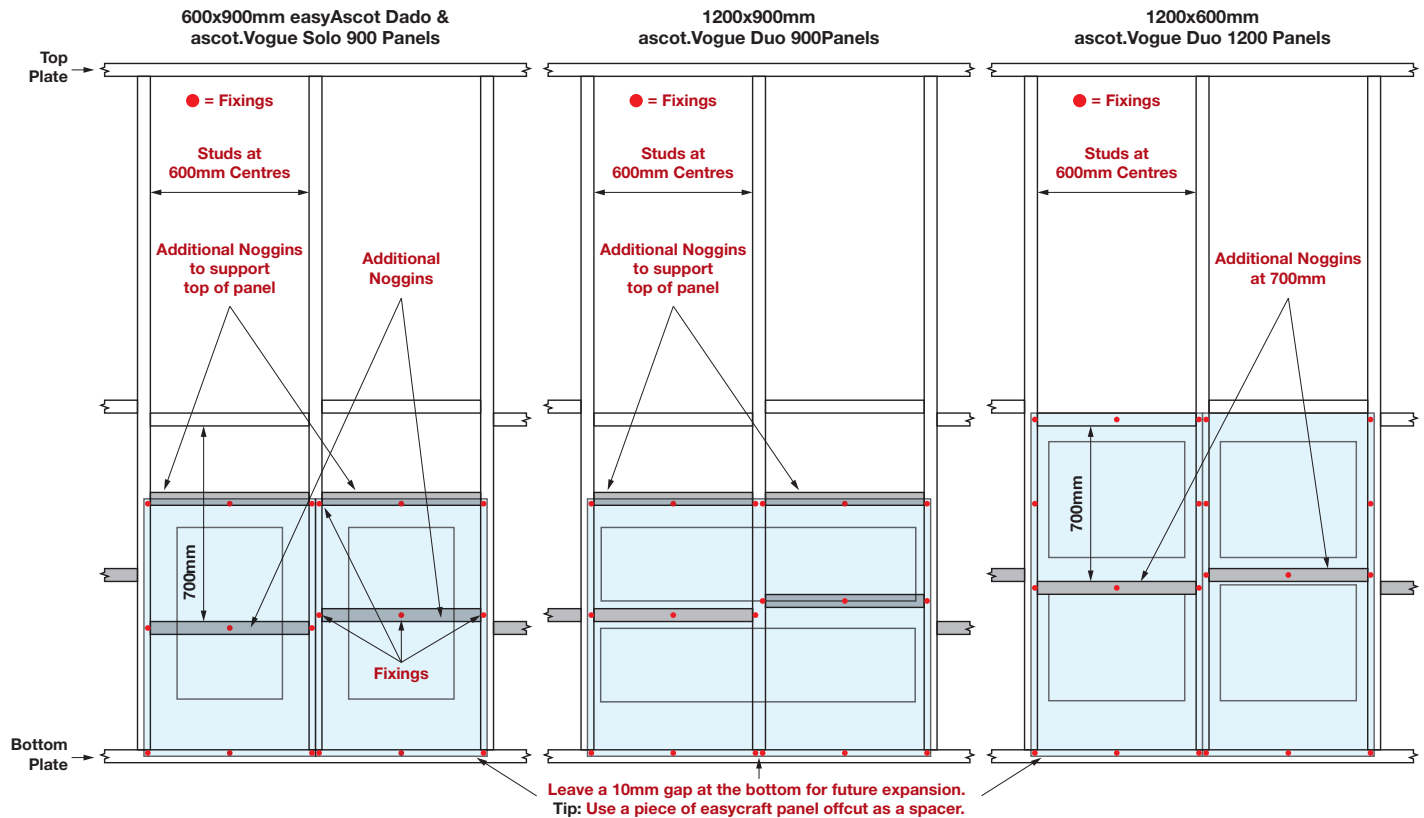

fixing horizontally to timber or steel frames

Tip: To avoid butt joints when installing horizontally, use a panel long enough for the entire length of wall. easycraft panels are available from 2400mm to 4500mm. See finishing options for internal/external corners.

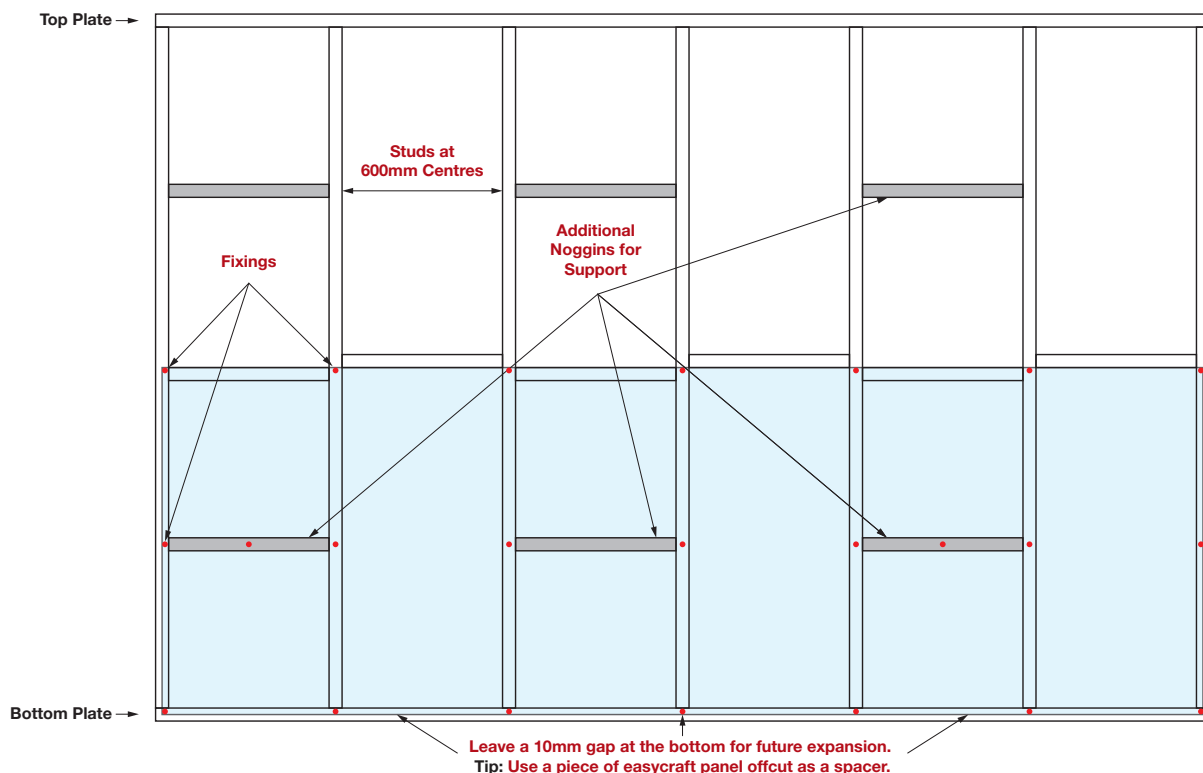

fixing easyascot to timber or steel frames

Step 1 - Preparing the frame:

1. Studs must be spaced at 450mm centres or less.
2. Place a noggin behind at top of panel to support top edge.
3. Check that frames are straight and true. Fix any irregularities.
4. Refer to the Drawings for frame layout.

Step 2 - Installing the sheets

1. Measure and mark the centre of the wall.
2. When installing Easycraft sheets over stud walls apply generous dollops of flexible construction adhesive at 600mm intervals on each stud and each noggin behind the first panel.
Follow the adhesive manufacturers recommendations for how much to use.
3. When installing easyAscot over existing walls apply 5mm bead in zig zag pattern of flexible construction adhesive over existing lining. Follow the adhesive manufacturers recommendations for how much to use.
4. Place a 9mm or 10mm piece of timber or off cut of MDF under the bottom edge of the panel, to raise it off the floor. You must allow a 9mm or 10mm gap at the bottom all panels.

5. Work from the centre of the wall out, ensuring you have equal number of panels on either side of the centre.
6. Check the panel is plum (vertical) using a spirit level and fix the panel using nails.
7. Fix nails 50mm from side and 10mm from top and bottom of panel.
8. Remove the spacer from the bottom of the panel.
9. Fix the other panels using the same method outlined above, working out from the centre panel to the corner.
10. Make sure you leave a 1.0mm to 1.5mm gap at each join to allow for expansion of the panels.
11. When you get close to the corner or a doorway, measure the gap from the fixed panel to the corner, cut and use the primed reverse side of the easyAscot sheet to finish the wall.
12. When all the sheets are fixed fit skirtings and architraves and finish off internal and external corners.
13. Fix dado rails to cover top of the sheet ensuring that it is level.
14. For the best result, a flexible (25% movement capability) paintable sealant must be used when fixing skirtings, cornices and timber mouldings to Easycraft Products. Easycraft recommends FulaSeal 720 and SikaflexPro+.

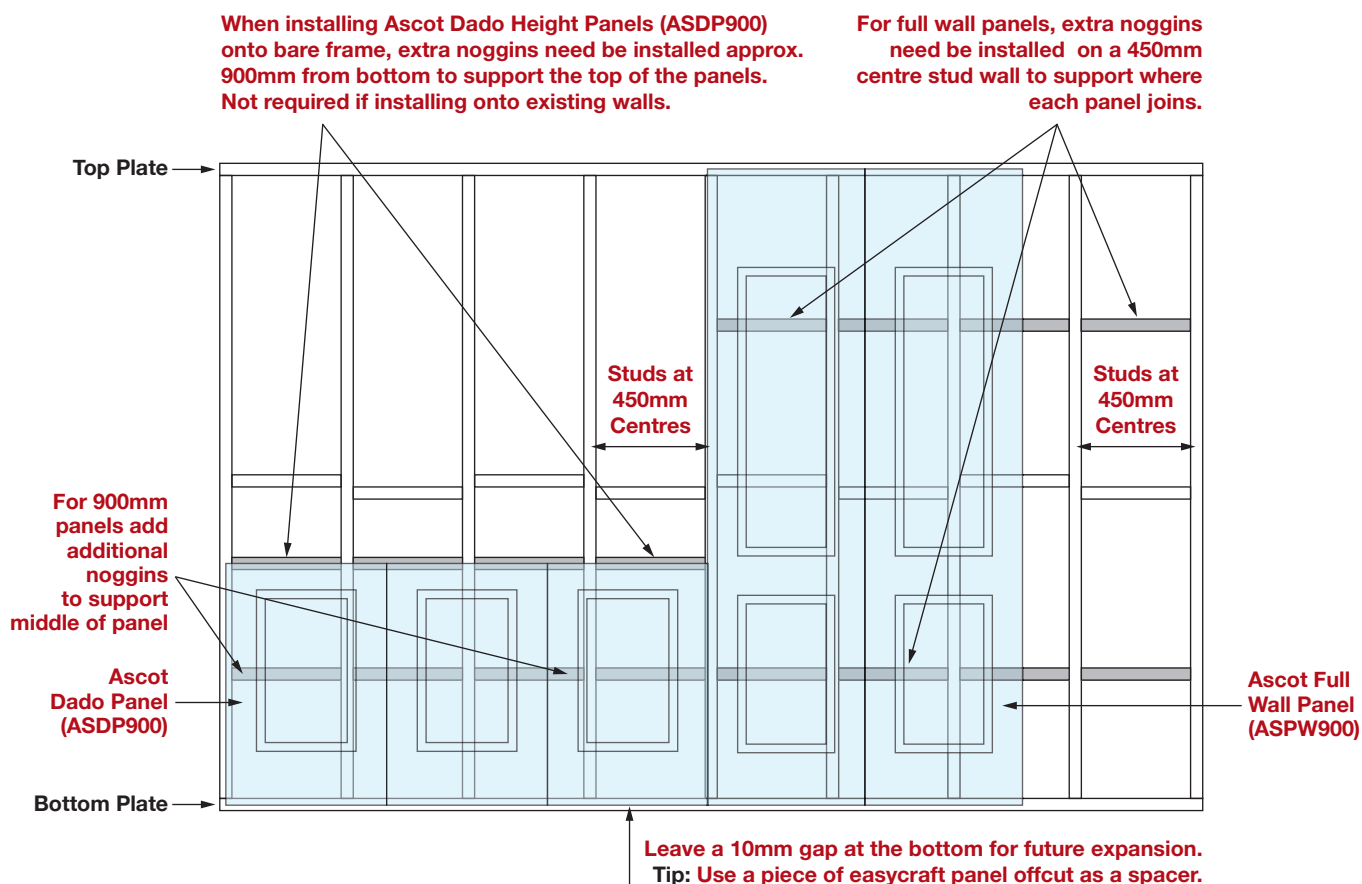

Note: Should you encounter a window, Easycraft offer an ascot classic window panel that can be docked to suit and maintain your profile. Refer website for more information. (need to add window panel to ascot product page)

fixing to existing wall

Step 1 - Preparing the Frame:

1. Studs must be spaced at no more than 600mm centres.
2. Where sheets are joined between studs place a noggin at 450mm to support the join.
3. When sheets are part way up the wall place a noggin at the top to support the top edge.
4. Check that frames are straight and true. Fix any irregularities.
5. Refer to the Drawings below for frame layout.

Step 2 - Installing the Sheets

1. Start from one corner of the room.
2. When installing Easycraft sheets over stud walls apply generous dollops of flexible construction adhesive at 600mm intervals on each stud and each noggin behind the first panel. Follow the adhesive manufacturer's recommendations for how much to use.
3. Place a 9mm or 10mm piece of timber or off cut of MDF under the bottom edge of the sheet, to raise it off the floor. You must allow a 9mm or 10mm gap at the bottom and/or top of all sheets.
4. Place the first sheet on the wall.

5. Check the sheet is plum (vertical) using a spirit level and fix the sheet using nails.
6. Space the nails approximately 500mm apart, fixing the sheet to the studs and noggins.
7. Fix nails/screws 50mm from the side & 10mm from the top and/or bottom of the panel.
8. Remove the spacer from the bottom of the sheet.
9. Fix the other sheets using the same method outlined above, working along the wall from the first sheet.
10. Make sure you leave a 1.0mm to 1.5mm gap at each join to allow for expansion of the sheets.
11. When you get close to the corner or a doorway, measure the gap from the fixed sheet to the corner and cut the next sheet so that it fits the remaining space. Fix the sheet using the same method as described above.
12. When all the sheets are fixed fit skirtings and architraves and finish off internal and external corners.
13. For the best result, a flexible (25% movement capability) paintable sealant must be used when fixing skirtings, cornices and timber mouldings to Easycraft Products. Easycraft recommends FulaSeal 720 and SikaflexPro+.

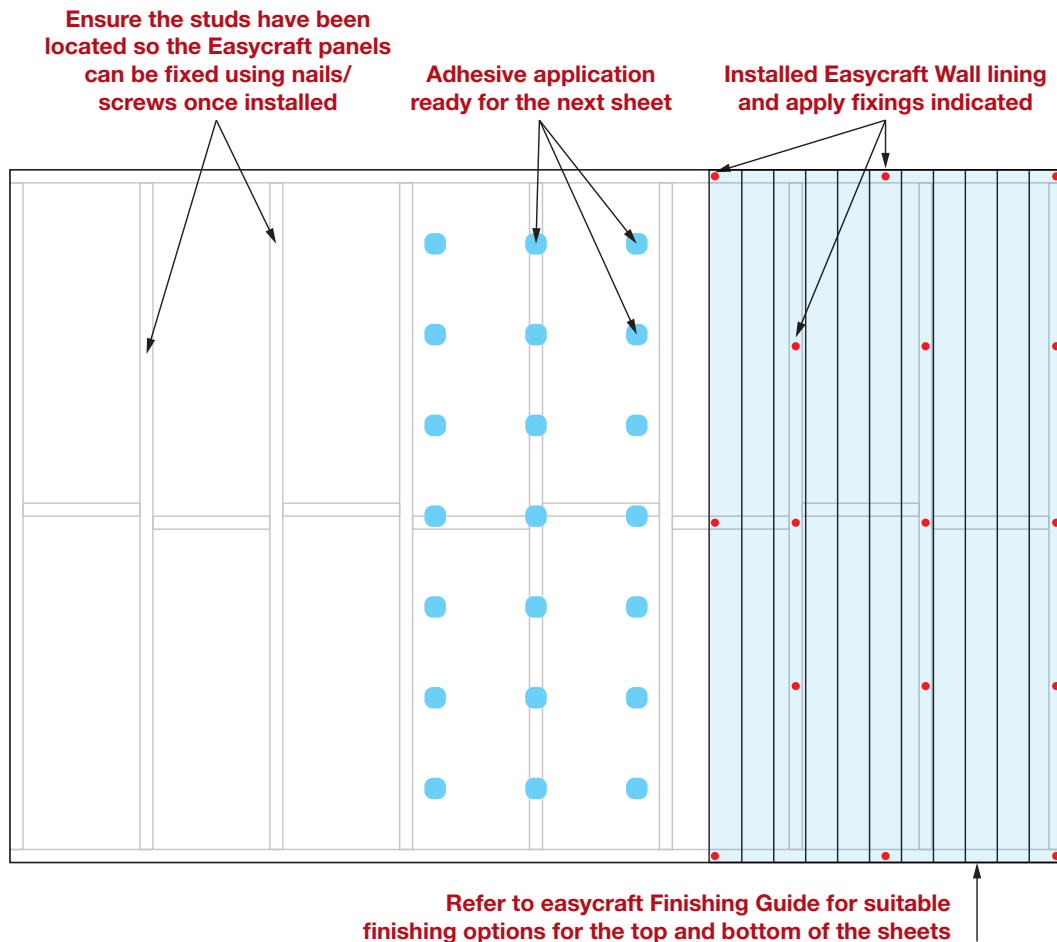

fixing to brick & block walls

Step 1 - Preparing the Wall:

1. Fix horizontal furring channels or battens to the masonry at 450mm centres
2. When sheets are part way up the wall place a noggin at the top to support the top edge.
3. Check that battens are straight and true. Fix any irregularities.
4. Refer to the Drawings for frame layout.

Step 2 - Installing the Sheets

1. Start from one corner of the room.
2. When installing Easycraft sheets over stud walls apply generous dollops of flexible construction adhesive on each batten behind each panel. Follow the adhesive manufacturer's recommendations for how much to use.
3. Place a 9mm or 10mm piece of timber or off cut of MDF under the bottom edge of the sheet, to raise it off the floor. You must allow a 9mm or 10mm gap at the bottom and top of all sheets.
4. Place the first sheet on the wall.
5. Check the sheet is plum (vertical) using a spirit level and fix the sheet using nails.
6. Space the nails approximately 500mm apart, fixing the sheet to the studs and noggins.
7. Fix nail/screw 50mm from side and 10mm from top and bottom of panel.
8. Remove the spacer from the bottom of the sheet
9. Fix the other sheets using the same method outlined above, working along the wall from the first sheet.
10. Make sure you leave a 1.0mm to 1.5mm gap at each join to allow for expansion of the sheets.
11. When you get close to the corner or a doorway, measure the gap from the fixed sheet to the corner and cut the next sheet so that it fits the remaining space. Fix the sheet using the same method as described above.
12. When all the sheets are fixed fit skirtings and architraves and finish off internal and external corners.
13. For the best result, a flexible (25% movement capability) paintable sealant must be used when fixing skirtings, cornices and timber mouldings to Easycraft Products. Easycraft recommends FulaSeal 720 and SikaflexPro+.

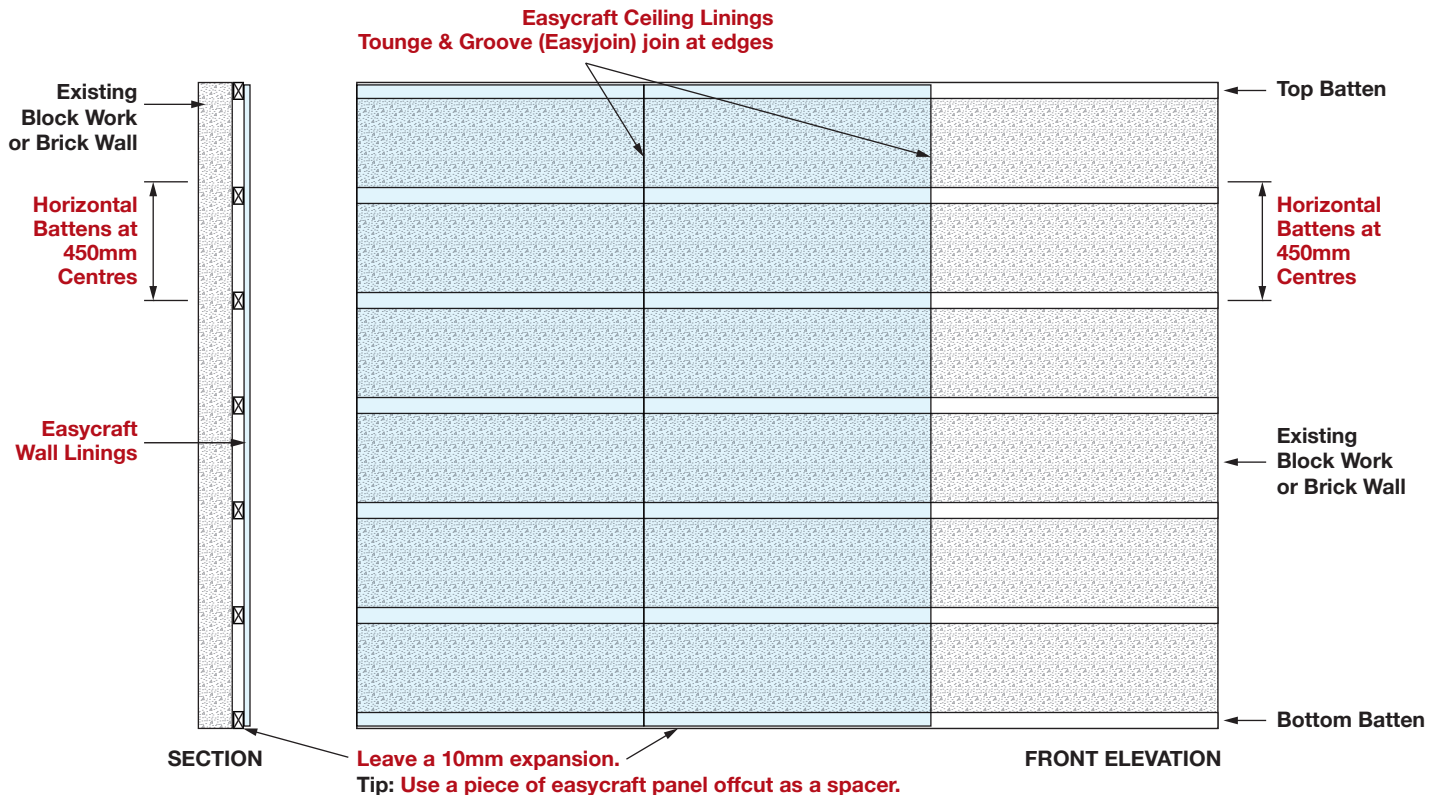

fixing to ceiling

Step 1 - Preparing the ceiling:

1. Check that the ceiling structure is straight and true. Fix any irregularities.
2. Run battens across the ceiling trusses at 450mm centres or less.
3. Refer to the Drawings for Truss and Batten layout above.

Step 2 - Installing the sheets

1. Easycraft recommends sheets be installed across the ceiling battens.
2. Start from one side of the room, working across the ceiling.
3. Apply generous dollops of flexible construction adhesive at 600mm intervals on each batten and any noggins behind the first sheet. Follow the adhesive manufacturer's recommendations for how much adhesive to use.
4. Position the first sheet and make an allowance for any battens that are out of square.
5. Fix sheet to the ceiling battens using nails or screws. Fill over the screw or nail holes a flexible timber filler before painting.
6. Check the sheet is level using a spirit level and adjust the level using the screws. The adhesive will take up any gaps between the Easycraft sheet and the batten.
7. Space the screws or nails approximately 400mm apart, fixing the sheet to the battens. Fixings must penetrate the battens at least 30mm.
8. Fix the other sheets using the same method outlined above, working along the ceiling from one side to the other.
9. Make sure you leave a 1.0mm to 1.5mm gap at each join to allow for expansion of the sheets.
10. When fixing the last sheet, measure the space remaining and cut the sheet 10mm shorter than the space to be filled.
11. Square set junctions- A P50 shadow line or a tear away bead can be used to control the wall/ceiling junction and allow room for movement of the two different substrates. A flexible timber filler is recommended.
12. For the best result, a flexible (25% movement capability) paintable sealant must be used when fixing skirtings, cornices and timber mouldings to Easycraft Products. Easycraft recommends FulaSeal 720 and SikaflexPro+.

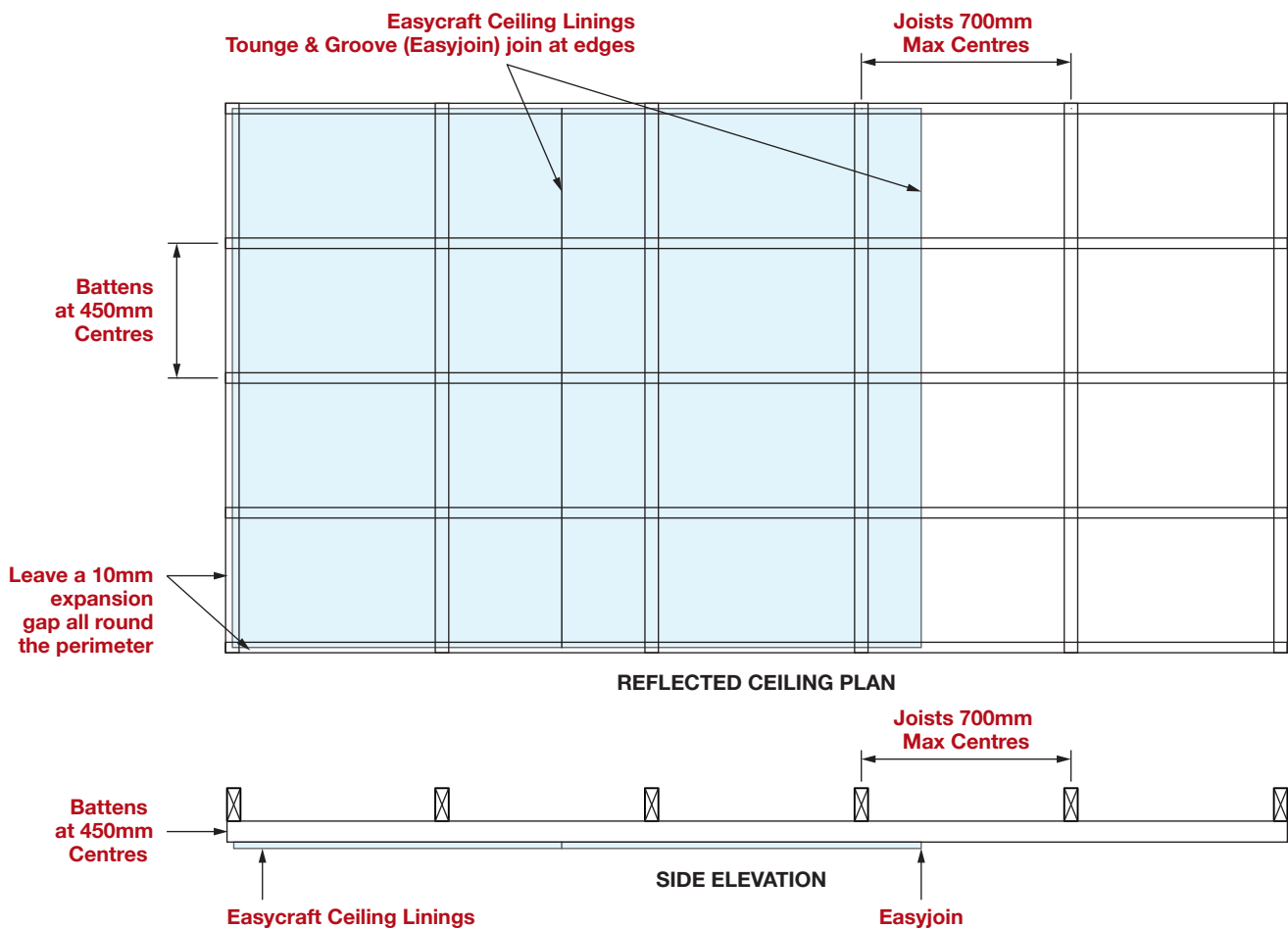

DISCLAIMER: Easycraft's Wet Area Interior panels cannot be used in direct 'wet areas', such as showers or as splashback (where the vessel is within 75mm of the wall). Easycraft WET AREA Interior linings can line all other areas including walls and ceilings within bathrooms and laundries. (in accordance with AS 3740 and NCC Volume One, F1.7 and Volume Two, 3.8.1).

Step 1 - Preparing the frame:

1. Studs must be spaced at 450mm centres or less.
2. Where sheets are joined between studs place a noggin at 700mm maximum to support the join.
3. When sheets are part way up the wall place a noggin at the top to support the top edge.
4. Check that frames are straight and true. Fix any irregularities.
5. Refer to the Drawings for frame layout below.

Step 2 - Installing the sheets

1. Start from one corner of the room.
2. When installing Easycraft sheets over stud walls apply generous dollops of flexible construction adhesive at 600mm intervals on each stud and each noggin behind the first panel. Follow the adhesive manufacturer's recommendations for how much to use.
3. When installing Easycraft sheets over existing walls apply 5mm bead in zig zag pattern of flexible construction adhesive over existing lining. Follow the adhesive manufacturers' recommendations for how much to use.
4. Place a 9mm or 10mm piece of timber or off cut of MDF under the bottom edge of the sheet, to raise it off

the floor. You must allow a 9mm or 10mm gap at the bottom and top of all sheets.

5. Place the first sheet on the wall.
6. Check the sheet is plum (vertical) using a spirit level and fix the sheet using nails.
7. Fix nail/screws 50mm from side and 10mm from top and bottom of the panel.
8. Space the nails approximately 500mm apart, fixing the sheet to the studs and noggins.
9. Remove the spacer from the bottom of the sheet.
10. Fix the other sheets using the same method outlined above, working along the wall from the first sheet.
11. Make sure you leave a 1.0mm to 1.5mm gap at each join to allow for expansion of the sheets.
12. When you get close to the corner or a doorway, measure the gap from the fixed sheet to the corner and cut the next sheet so that it fits the remaining space. Fix the sheet using the same method as described above.
13. When all the sheets are fixed fit skirtings and architraves and finish off internal and external corners.

Step 4 - Finishing Corners

- Refer to finishing/detailing -junction suggestions on page 13 & 15.

Bath with fixed shower screen

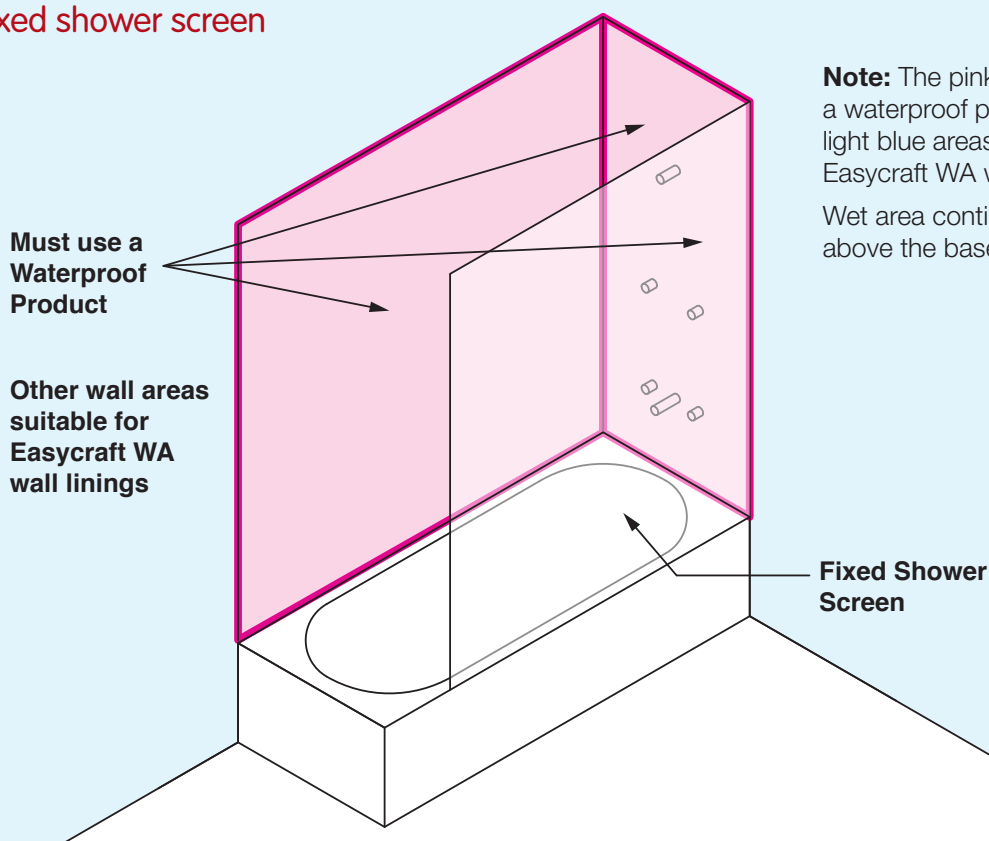

Note: The pink area requires a waterproof product. All other light blue areas are suitable for Easycraft WA wall linings.

Wet area continues to 1800mm above the base of the bath.

Shower & bath with shower screen.

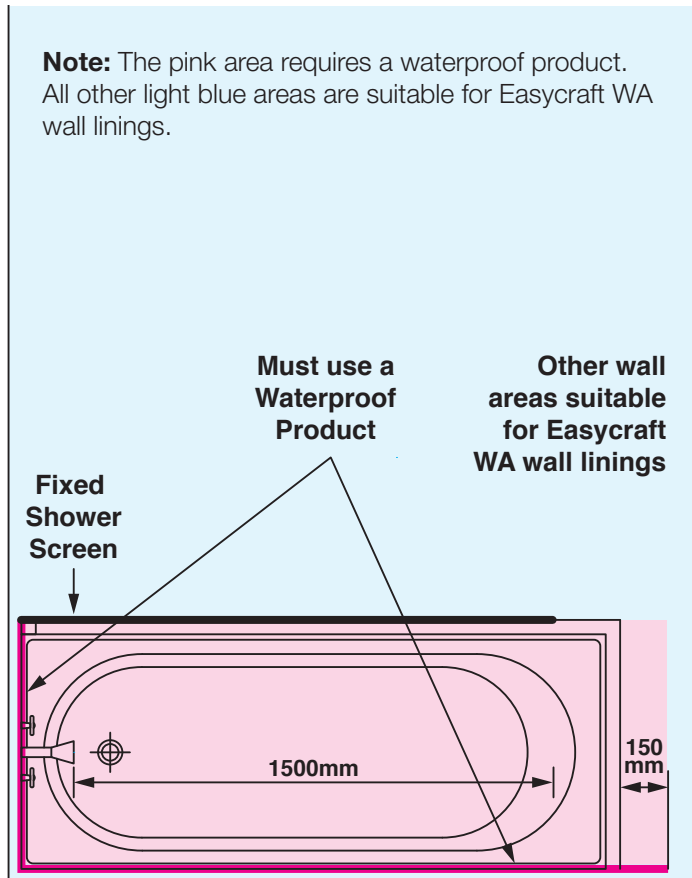

Basin abutting wall

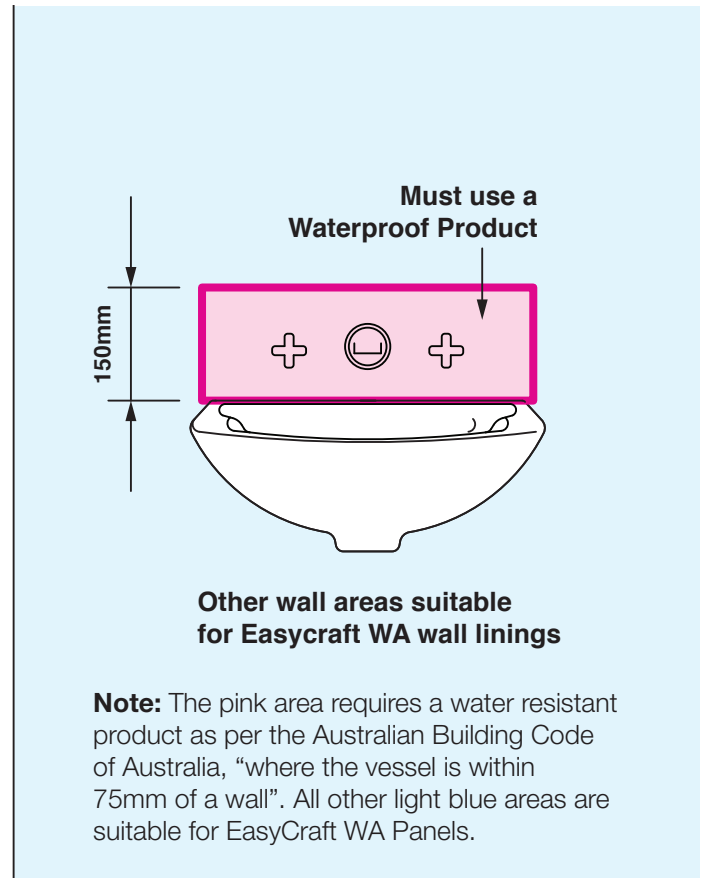

Wet area Tile Floor

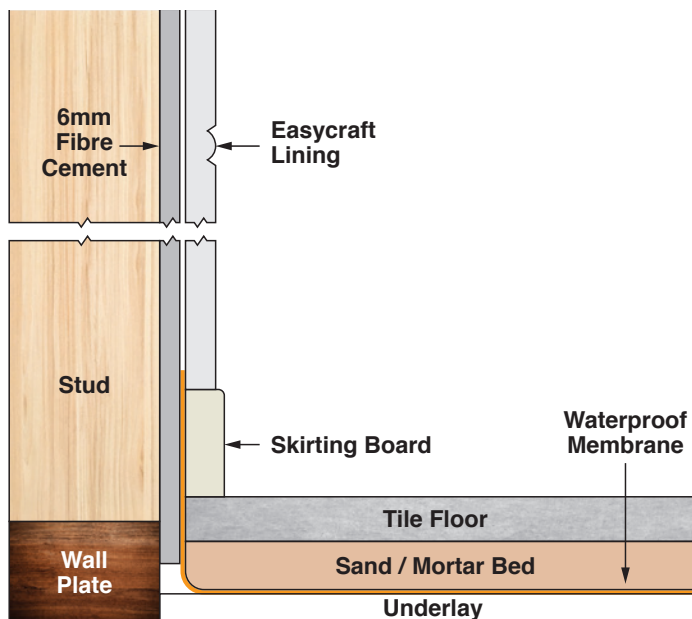

Wet area Tile Floor

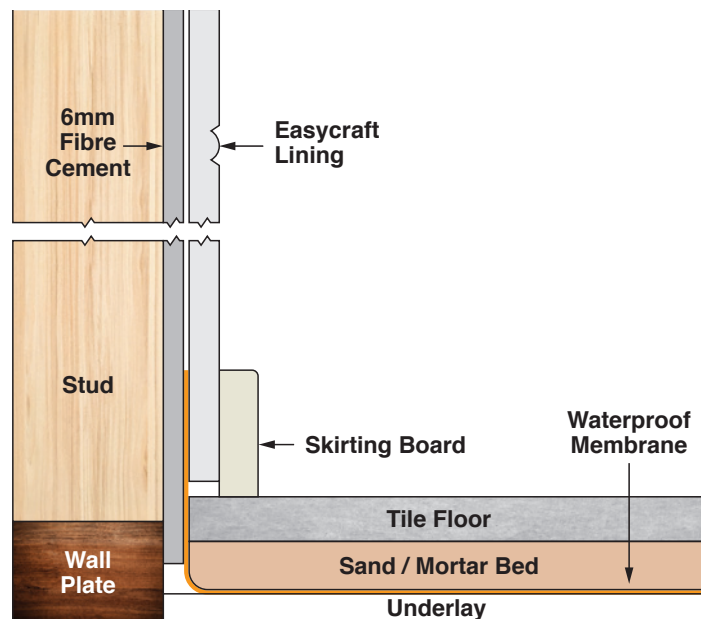

finishing options - mouldings

There are many options for finishing Easycraft panels in wall & ceilings applications, similar to plasterboard. We highlight below some examples of preferred finishing options for corners and end joining. These products are available direct from most timber and hardware retailers.

Visit easycraft.com.au for videos on how to install Easycraft wall panels.

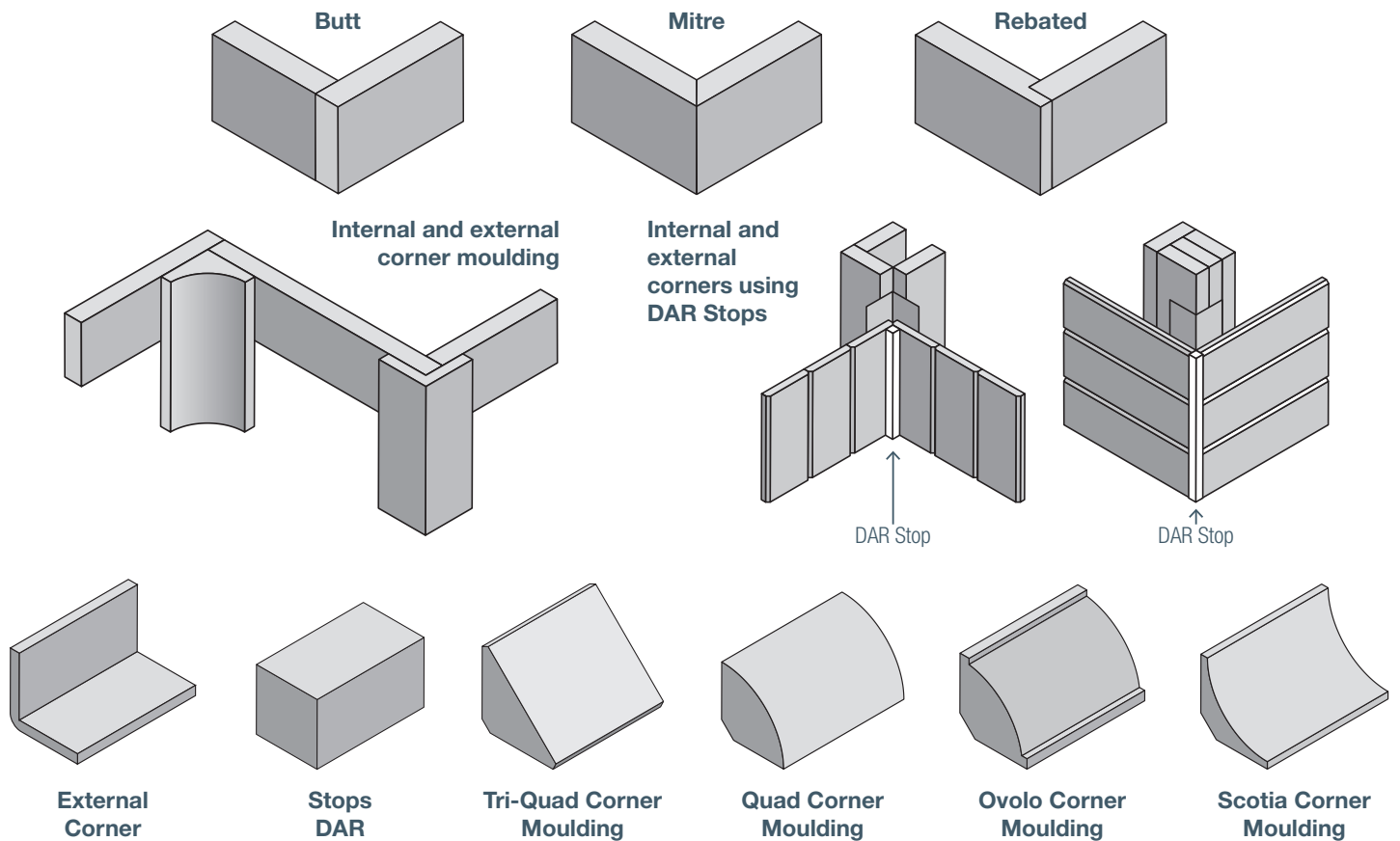

easycraft finishing dado rails

Below are some examples of product found in your local Reseller that may compliment and provide options in finishing off your Easycraft panel project. **Note: Easycraft supply 4 dado rails that suit our dado size panels (rebated) and full wall size panels (flat).**

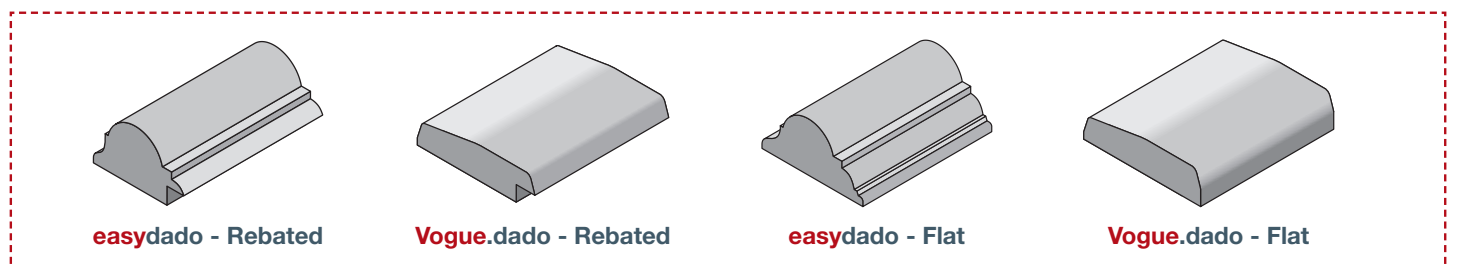

wall to floor finishing options

Floor to Wall

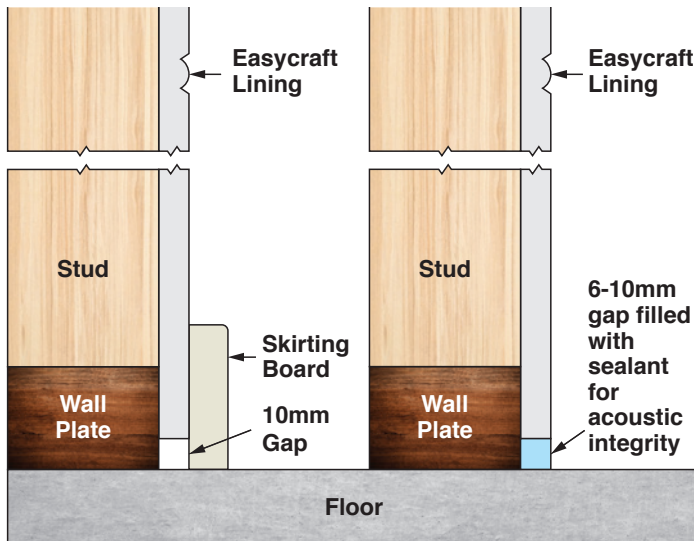

Shadowline skirt detail with Aluminium Angle

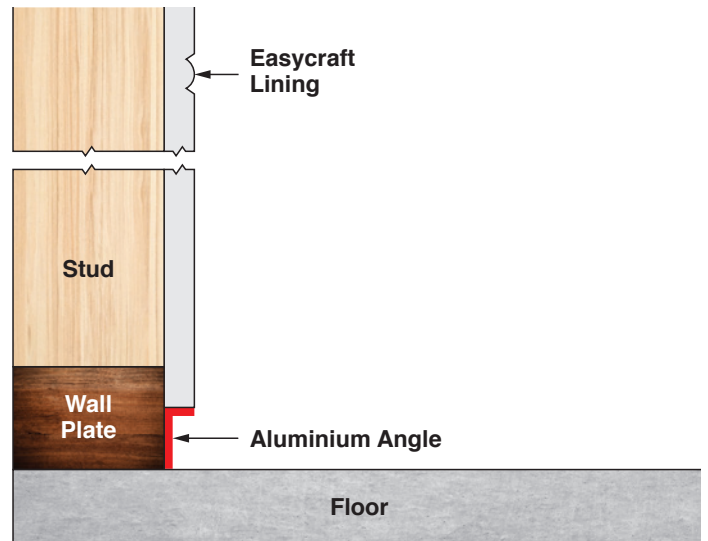

Direct alternative Skirting/Easycraft

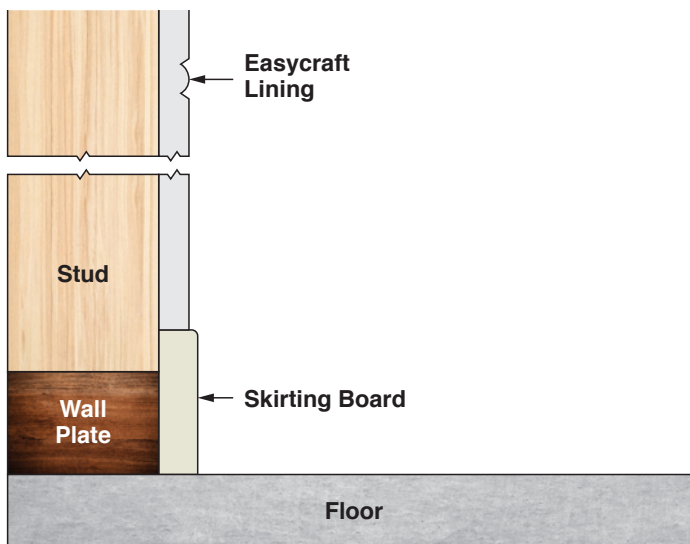

Applied over Existing Plasterboard

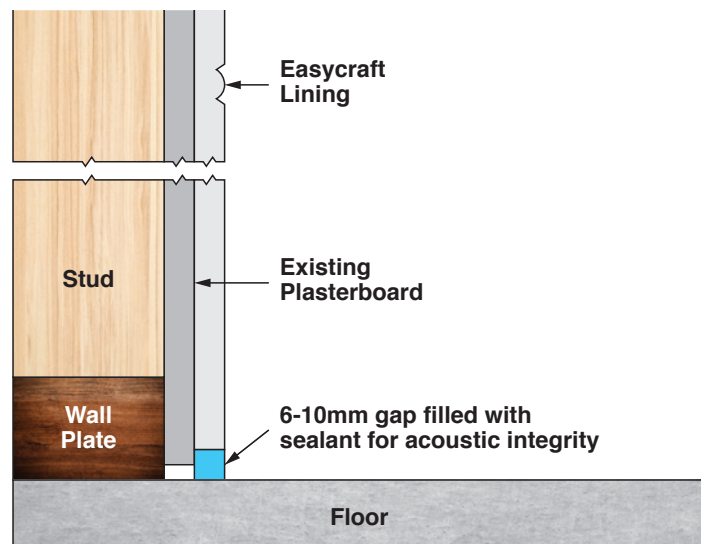

Dado Panel - New Build / Against the Frame

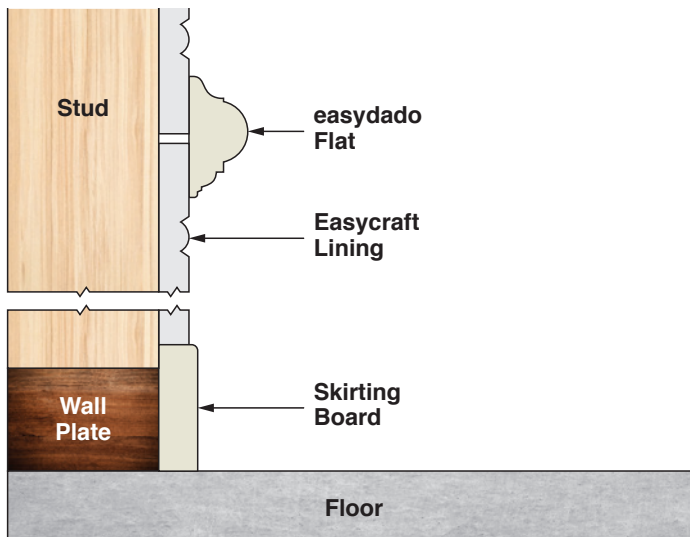

Dado Panel - Renovation / Over Plasterboard

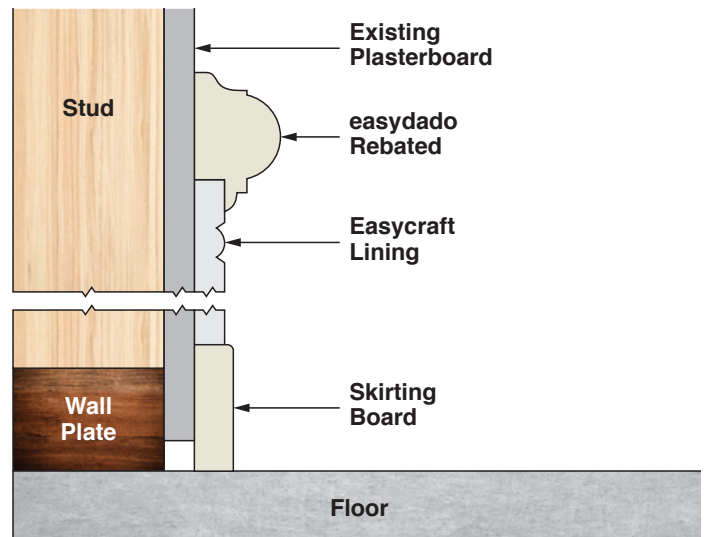

ceiling finishing options

Wall to Ceiling Options

Cornice can be Timber cornice/mould

- Plaster cornice
- Timber quad/bead, Quad, Scotia, Ovolo.

There are many plasterboard cornices and timber mouldings that can be used and are available through any timber and hardware and plasterboard supplier for your choice and selection, the above are suggestions, it is not limited to the images and profiles we have displayed, what we hope to achieve is to indicate there are many different ways to finish/detail Easycraft Panels.

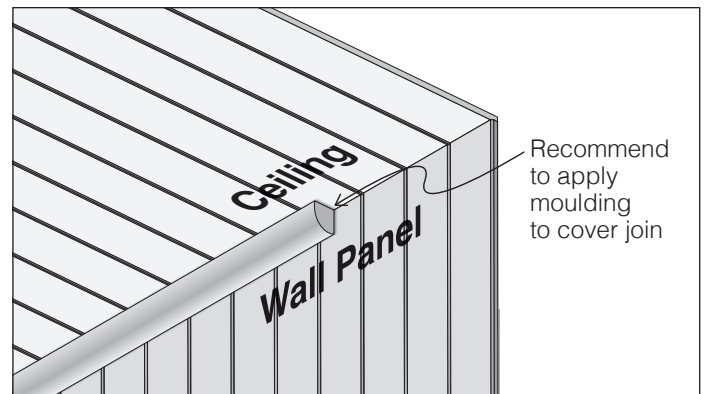

Plaster or Timber Cornice

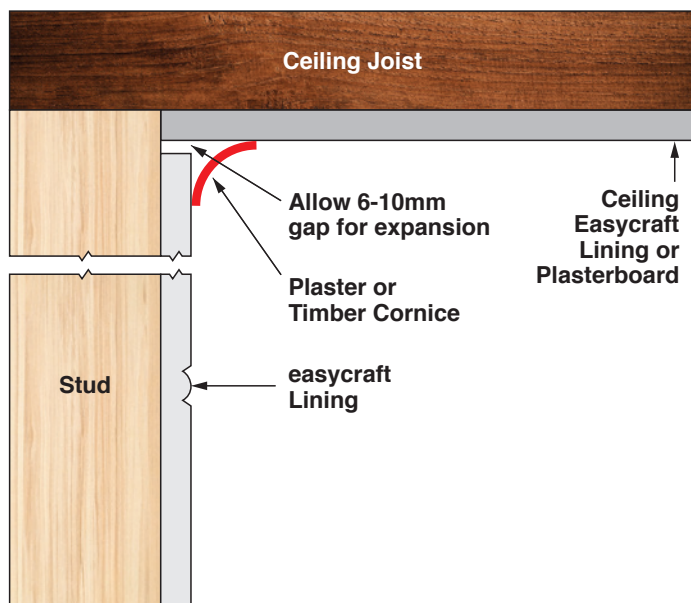

Butt End Alternatives

Generally, Ceilings, longer sheets are required (may also apply to walls where the product is being used horizontally).

Where sheets are required to join end to end (easycraft recommend not end butting sheets, as movement of the building frame along with any environment change may mean the panels move marginally, which in turn cracks the join sealant (gap filler) and paint (leaving an unsightly jagged cracked caulk join).

We recommend looking at alternative ways of detailing sheets that are required to meet so the profile may continue, avoiding joining sheets butt end to butt end.

Square Dressed Cover Mould

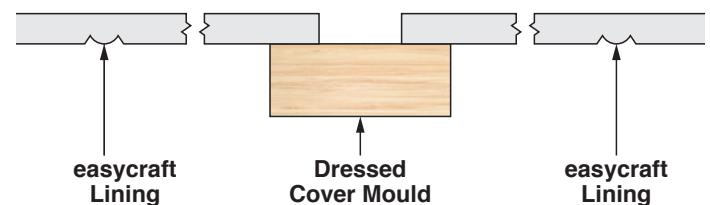

Shadow-line (Plasterboard Trims) Ceiling Options

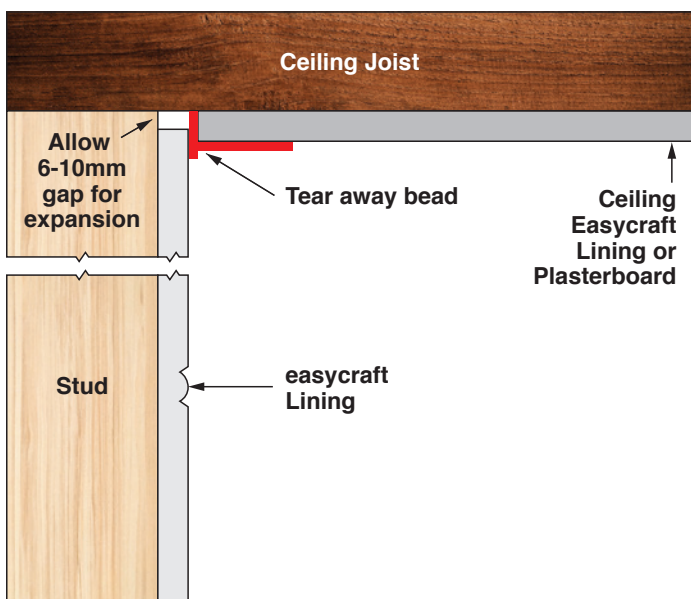

finishing - paint

Pre-primed

Easycraft panels come pre-primed. Easycraft apply a commercial grade water-based primer that is cured during their manufacturing process by a combination of a UV light and an oven.

Preparation

Before painting is commenced it is important to ensure the surface of the Easycraft panel is properly prepared.

Fill all nail/screw holes and imperfections with a suitable water-based wood filler (such as Timbermate) and allow to dry.

Lightly sand all surfaces to be coated so as to obtain a smooth and even finish.

Dust off all sanded surfaces using a damp rag before painting commences.

Undercoat (you may apply another)

For conventional painting, the recommended type of undercoat or primer is a water-based acrylic type. Apply the coating in accordance with the manufacturer's instructions. When dry, all painted surfaces should be sanded smooth. It is recommended that the acrylic undercoat should not be watered down prior to use.

Final Coat

Ideally, an acrylic coating is selected as a top coat. Generally, paints that can be applied to plasterboard, work identically when applied to easycraft panels.

Application of paints is typically by brush roller or spray. Brushes are used for small areas, cutting in the edges and profiled areas.

Rollers are typically used for large areas such as walls and ceilings.

Spraying should only be considered if you have the right equipment and expertise.

Paint Manufacturer's Warranty

Please note:

Paint Manufacturers' may not offer a warranty when applying their paint product onto another manufacturer's base primer.

We recommend you trial the application of the final paint coat onto our primer prior to installation and your final application.

Easycraft products can be ordered as raw, un-primed to allow you to apply both the base primer and final coat from the paint manufacturer of your choice.

Wet Area Paint Finishes

easyUltra Wet Area Interior board must have the front face (exposed) surface and ALL edges completely sealed with a sealer undercoat and should have at least two (2) coats of acrylic top coat paint, or as advised by the paint manufacturer, prior to being exposed to any area where moisture may be present.

Any other part of the panel where the raw board is exposed, i.e. after cutting, must have, unless the paint manufacturer advises otherwise, at least one (1) coat of primer and two (2) coats of acrylic top coat paint, applied prior to being exposed to any area where moisture may be present.

To avoid warping or cracking, dark colour paints must be avoided. The light reflective value (LRV) should be 50% or above for interior applications.

Please refer to your paint supplier for the LRV of the paint to be applied.

Always use good quality paint, following the paint manufacturers' instructions on the number of coats required, low gloss or satin finish paints are recommended for best finish.

Semi-exterior Paint Finishes

Easycraft's semi-exterior boards are best paired with 100% acrylic latex (water borne) solvent-based paints. For the best long-term outcomes, we recommend using premium branded exterior acrylic paint.

Apply two coats direct to the primed easycraft semi-exterior panels, ensuring that the bottom edges are fully coated. Allow the recommend drying time (minimum of 2 hours).

Always ensure the easycraft semi-exterior panels are painted within 60 days of fixing.

finishing - lacquer/stain

Finishing of Veneered Surfaces

It is recommended that veneered surfaces be finished with a protective coating or lacquer to protect them from the rigours of day to day usage. It is essential to seal all surfaces including edges of all components and assemblies to slow the ingress of moisture.

Panels not sealed in this manner are prone to bow or cup.

Selection of the surface coating or lacquer to meet the end environment of the finished veneered surface, and for that matter the veneer colour and species, are very important factors influencing the expected life of the surface.

Minimising colour change

The variation of colour within species is a natural and valuable characteristic of wood. These natural differences make solid wood and veneers much more attractive materials than the products that seek to imitate wood's appearance.

The adverse effects of exposure to UV light of items made of natural fibres, wood, and plastics (e.g. fabrics, carpets, timber products, and coatings) is well recognised. The fundamental fact is that all articles subjected to UV light change colour and appearance in some way as they age. The only difference being the amount of change and the time period over which it happens.

As with all other natural or synthetic materials, veneers (as well as solid wood) will change colour over time when exposed to sunlight. The degree of colour change varies with the amount of light the coating and wood is exposed to. Generally, the surface closest to the UV light source is affected more rapidly than areas further away from the light. **The exposure to UV light usually results in a gradual bleaching of red/dark woods and a yellowing of blonde woods.** Generally, the application of protective clear coatings containing UV-absorbing additives significantly reduces the detrimental colour change of veneers caused by UV radiation originating from sunlight exposure.

It is important to highlight that generally the application of protective clear coatings containing UV absorbing additives reduces, but does not completely eliminate, wood discolouration caused by UV radiation originating from sunlight.

Coatings that do not contain the above additives may not offer optimal protection against UV discolouration. It is likely that yellowing and degradation of the coating itself may occur, resulting in higher discolouration compared to the uncoated veneer.

General Care of Coated Veneered Surfaces

The on-going, in service, care of finished veneered surfaces depends largely on the type and quality of the coating utilized. Thus, the manufacturer of the finish should be involved in preparing the recommended care instructions for the furniture, joinery or fit-out. This can occur at the specification stage or by the chosen joiner/cabinetmaker as they are the people in control of the final product and finish.

In general, timber veneered surfaces should not be left wet/damp or with wet staining materials on them (such as dark fruit juice/wine). They should not be cleaned with harsh cleaners or chemicals that affect the surface finish. Abrasive cleaning of clear finishes can scratch the surface and reduce the visual clarity.

Veneered products are not suitable for high wear and wet horizontal surfaces such as kitchen counter tops, unless the veneer is completely encased within a suitable resin system. Veneer surfaces (like all coloured materials) will always change colour, to a greater or lesser degree, particularly upon exposure to natural and artificial light. The degree of colour change will depend on such factors as the species chosen, the coating type used and the intensity and period of time of exposure to light. Some stains, notably dye stains, can fade if subjected to long term ultra violet light.

In addition, conventional coatings have a tendency to yellow with age which can have quite a dramatic effect on the original colour of the stain/timber veneer selected. To minimise this, low-yellowing finishes can be specified

grooved panel curvature

This diagram represents a test conducted internally by Easycraft on the bending characteristics of a: **easyVJ100 - 1200mm wide x9mm thick MDF MR Decorative Panel.**

The test was to bend the panel across the 1200 width to a point where the board split at a grooved profile section. We believe the board will bend equally with either the VGroove profiled face being on the concave or convex side. This represents a radius of arc of 1335mm at an angle of 52%.

Greater results can be achieved by scoring the rear side of the panel enough so that it may be manipulated further. Easycraft recommend you consult with your builder, shop fitter, cabinet maker to achieve further results.

Note: Easycraft will not be held responsible in any way for any breakage incurred whilst attempting to bend a profiled Easycraft panels. They have not been manufactured to bend across the profiled face.

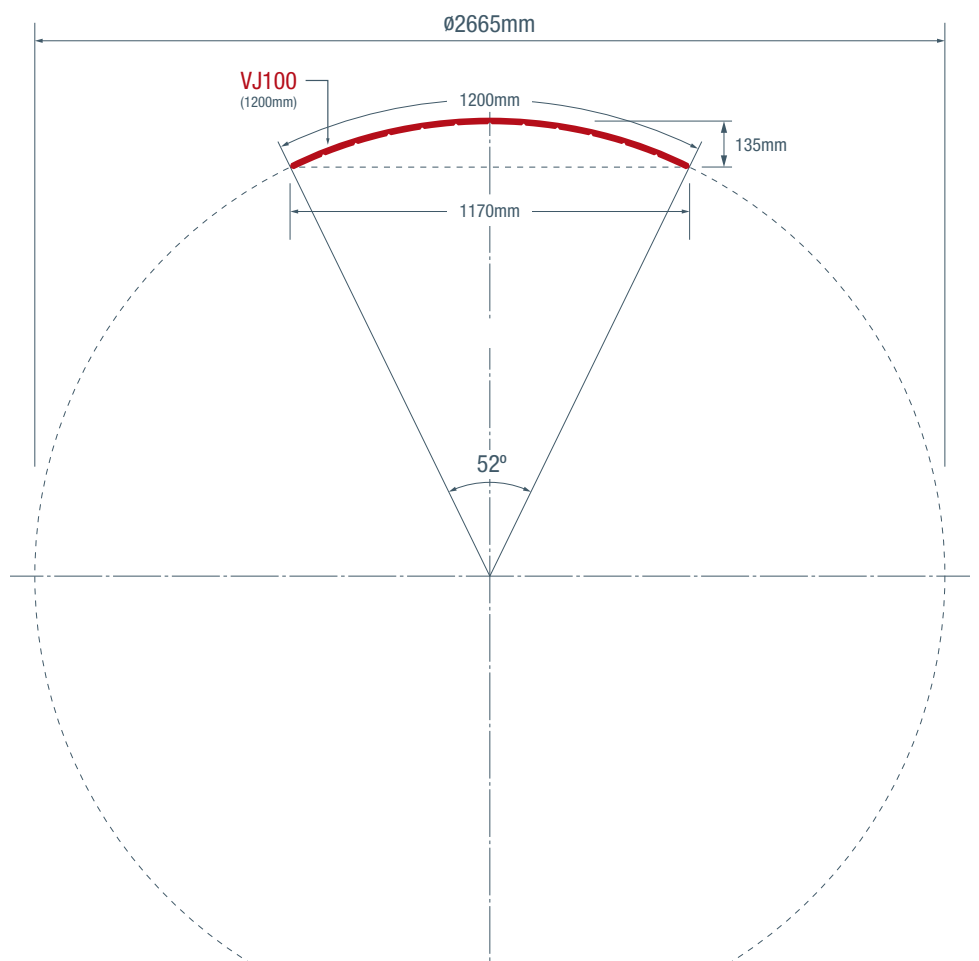

fireplace installation

Recommendations:

- It is our recommendation to follow the manufacturer's installation recommendations in conjunction with Australian and New Zealand Standard 2918.
- Manufacturers require at times non-combustible materials. Unfortunately, Easycraft General Purpose and Wet Area Interior, Semi Exterior and Fire Rated materials are all combustible.
- Special consideration needs to be taken when installing Easycraft panels near a fireplace to avoid any potential safety hazards.
- If you are unable to find the required information you can refer to the installation diagram below which outlines a common exclusion zone for timber-based products. Please note that this is a guideline only as recommendations will differ between manufacturers.

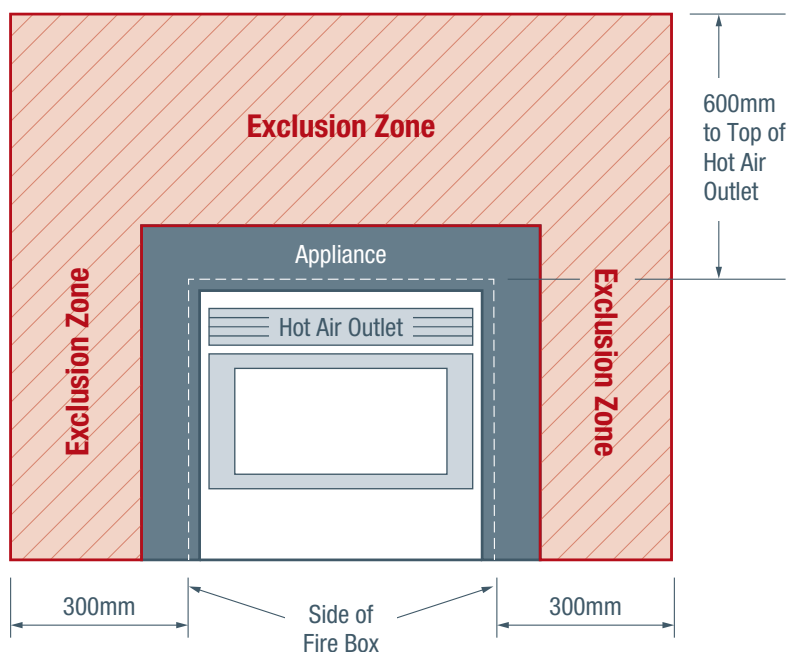

material references

The following documents can be viewed and downloaded at [easycraft.com.au](https://www.easycraft.com.au)

Installation Guide / Installation Videos

Product Data Sheets (PDS)

Safety Data Sheets (SDS)

Fire Test Results - AS 5637.1:2015 (AS/NZS 3837)

Chain Of Custody Certification

Global Green Tag Certification

Chain of Custody Product Schedule

Safe Work Method Statement

Health & Safety For Users

Material Handling & Storage

Bim (Revit), Cad - 3D Panel Drawings Provided

easycraft design partners

For more information or how you could become an easycraft Design Partner see Trade & Specifier drop down/Designer Partner on our website.

We would love to promote you and your designs using easycraft products.

limitations

The Information contained in this document is current as of December 2020 and is based on data available to Easycraft Pty Ltd at the time of going to print. All photographic images are intended to provide a general impression only and should not be relied upon as an accurate example of Easycraft products installed in accordance with this document or the BCA/NCC compliance documents.

This publication replaces all previous Easycraft installation information and literature relating to Easycraft products. Easycraft Pty Ltd reserves the right to change the information contained in this document without prior notice. It is your responsibility to ensure that you have the most up to date information available, including at the time of applying for a building consent. Architects, Builders and Building Surveyors responsibility to ensure Easycraft products are being installed to meet with the National Construction Code.

Easycraft Pty Ltd has used all reasonable endeavours to ensure the accuracy and reliability of the information contained in this document. However to maximum extent permitted by law, Easycraft Pty Ltd assumes no responsibility or liability for any inaccuracies, omissions or errors in this information nor for any actions taken in reliance on this information.

manufacturers warranty

The company warrants (for 24 months) against defects due to defective factory workmanship and materials provided the installation procedures are strictly observed. The obligations assumed under this warranty are limited to repair or replacement or monetary compensation of any manufactured products and does not cover consequential losses such as accident, transport, removal, labour or other cost. All replaced products must be returned for inspection. This warranty applies only to the original purchaser and is not transferable. This warranty does not apply if the product has been improperly stored, installed, subjected to misuse, misplacement, abuse, neglect, repair or alteration (other than by the company).

Without limiting any other terms of this warranty, this warranty does not cover and EasyCraft will not be liable for damage or defects which are not due to defective factory workmanship or materials, including but not limited to damage or defects caused by or arising from or in any way attributable to: (i) use of the Product in applications not recommended by EasyCraft; (ii) the Product being subjected to abnormal treatment; (iii) impact, abrasion or mechanical action; (iv) surface marking, scratches or stains arising during or after the installation of the Product; (v) poor workmanship or installation, poor design or detailing, settlement or structural movement and/ or movement of materials to which the Product is attached, incorrect application design of the structure (used wrong material/wrong place... e.g. Fire Rated used for fireplace surrounds, General Purpose used in Wet Area); (vi) acts of God including but not limited to earthquakes, fire, cyclones, floods or other severe weather conditions or unusual climatic conditions; (vii) efflorescence, normal wear and tear, growth of mould, mildew, fungi, bacteria, or any organism on any Product surfaces or Product (whether on the exposed or unexposed surfaces); (viii) contact with chemicals such as solvents, detergents and pollutants, or exposure to a harsh chemical environment or an excessively salty environment; (ix) use of adhesive tapes, sealants or mastics on the Product, or recoating of the surface of the Product outside of the recommended maintenance guidelines in the relevant EasyCraft literature; or (x) failure of third party coating systems, including but not limited to sealers and paints.

The Product is subject to natural variation in finish as part of the manufacturing process. EasyCraft is not liable for any variation in the look of the Product including but not limited to: any variation in colour or surface pattern; any variation between different batches of the Product; or any variation against any sample material provided.

The company shall not be liable for any defects in goods not manufactured by it but the company will endeavour to pass on to purchaser the benefit of any claim made by the company and accepted by the manufacturer for such goods under the warranty given by that manufacturer.

This guarantee is additional to any condition or warranty applying by virtue of the Competition and Consumer Regulations January 2012 and to all other rights and remedies had by a consumer of goods and services in law.

continuous improvement

Easycraft has a policy of continuous product testing and improvement. For this reason we reserve the right to make any changes or modifications to the information contained in this document as we consider necessary and without notice. Errors and omissions excluded.



Easycraft Pty Ltd

140 North Road, Wynnum West QLD 4178

Phone: 07 3906 7200

Email: marketing@easycraft.com.au

easycraft.com.au

 **easycraft**[®]
stylish solutions for walls and ceilings