

Roller Blind Installation Instructions

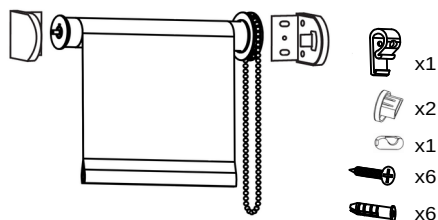

Components and Fittings



- x1
- x2
- x1
- x6
- x6

Brackets (2x), winding mechanism (1x), endplug (1x), tension device (1x), endcaps to bottom rail (2x), cord connector (1x), screws (6x), wall plugs (6x)

Tools Required

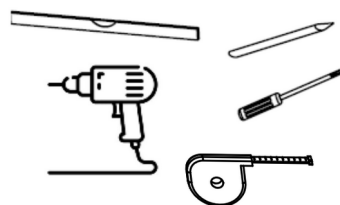

Spirit level, tape measure, pencil, drill, Phillips head screwdriver

Possible Installation Positions

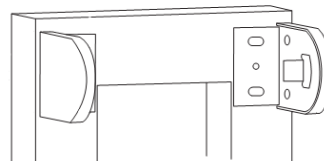

Face Mount

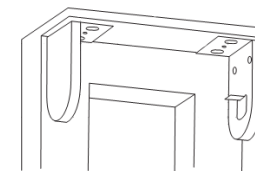

Ceiling Mount

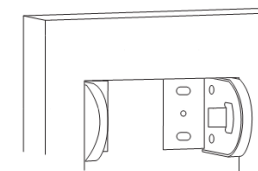

Recess Mount

Note: A light gap of approximately 15-20mm between fabric and frame may be present to allow for fitting each side.

Step 1. Check Measure

Measure the window to confirm the correct size.

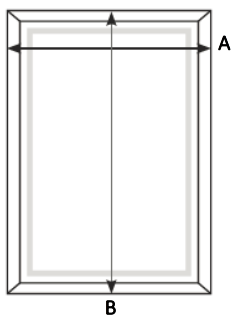

Face & Ceiling Mount:

Measure from one edge of the architrave/wall to the other. You may want to keep extra 20-30mm on both sides of the blind for a better light protection

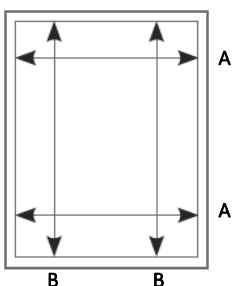

Recess Mount:

Measure inside the window frame at the top and the bottom of the frame to ensure the window frame is straight. In case you receive different readings, a smaller dimension should be considered.

Step 2. Roller Blind Position

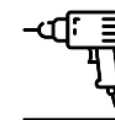
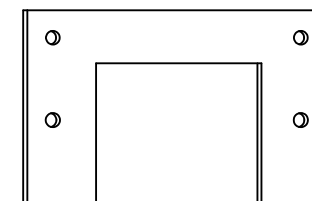
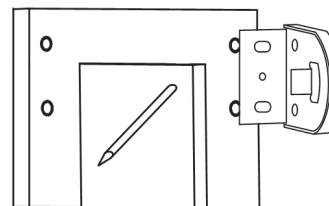

Use a pencil to check and mark the position of the installation brackets, including fixing positions. The ideal position of the bracket holes should be approximately 12mm from the edge of the blind, fittings included. Pre-drill holes for bracket screws.

Step 3. Fix the Brackets

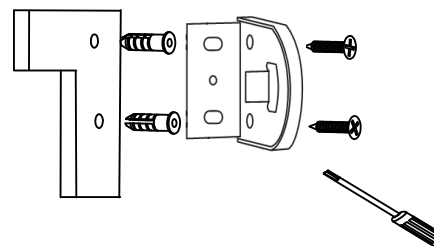

Fix the brackets using screws included and a drill or a Phillips head screwdriver.

For installation in plaster walls use wall plugs provided in the package.

Product not suitable for installation in metal surfaces made of steel. In order to install in aluminium frames pre-drill holes of 2.0-2.5mm diameter for bracket screws.

Roller Blind Installation Instructions



Step 4. Installation

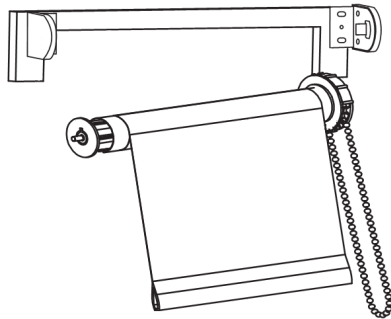

First insert the winding mechanism onto the matching bracket, then insert the endplug with the pin onto the opposite bracket.

Adjusting the chain's length (optional)

The chain can be shortened using the chain connector provided. In order to shorten the chain, please roll the blind all the way up. Please cut the front of the chain only approximately 30mm below the winding mechanism. Attach the chain connector.

Step 5. Adjusting the Roller Blind (Optional)

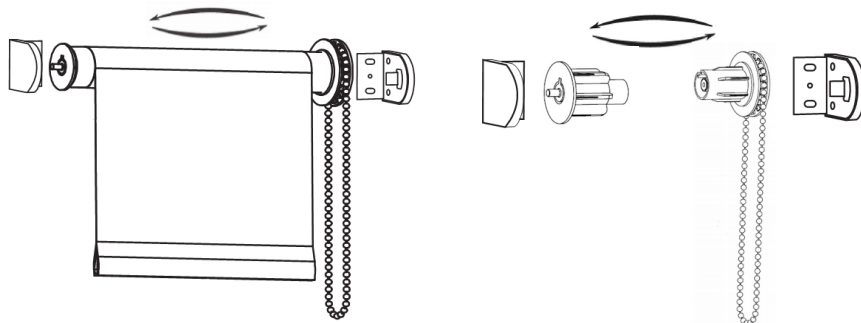

Chain mechanism with a matching bracket can be swapped from left to right and right to left according to individual preferences. This needs to be decided upon prior to the bracket installation.

WARRANTY: Our goods come with guarantees that cannot be excluded under the Australian Consumer Law. You are entitled to a replacement or refund for a major failure and compensation for any other reasonably foreseeable loss or damage. You are also entitled to have the goods repaired or replaced if the goods fail to be acceptable quality and the failure does not amount to a major failure. The benefits given by this warranty are in addition to other rights and remedies which may be available to the consumer under any law in relation to goods or services to which this warranty relates.

Any claim under warranty must be made within 3 years of the date of purchase of the product. To make a claim under warranty, return the product full with proof of purchase to Markisol, Markisol will repair or replace the product or refund the purchase price. Any expense in claiming the warranty will be paid by the customer. The warranty covers manufacturer defects in materials, workmanship and finish under normal use. The warranty does not cover general wear & tear and commercial applications. You may submit details and proof of purchase to: Markisol Australia Pty Ltd, 23 Citivest Court, Altona North VIC 3025; ABN 46 622 915 093, email: info@markisol.net.au; www.markisolgroup.com.au

Step 6. Install Child Safety Device

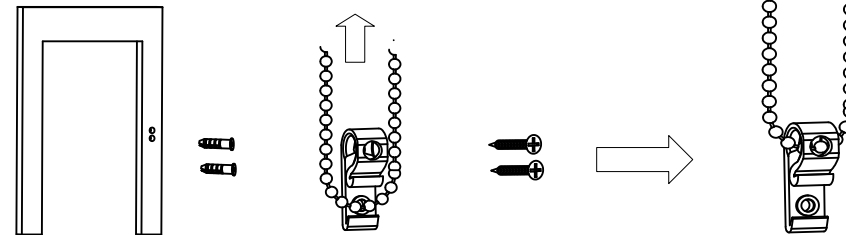

Install the tension device using screws provided in the pack. Adjust the position, so that the chain could pass through the safety device freely. Tension device included in the package must be installed in order to avoid creating a possible strangulation hazard for children!

Care and Maintenance:

Surface dust may be removed with gentle brush, feather duster, clean dry cloth. If the blinds are especially dirty, use the brush attachment on the vacuum to gently brush over the surface. A solution of lukewarm water and mild detergent may be used to spot clean stains and smudges. Always spot test in inconspicuous area before cleaning. Do not wash. Do not dry clean. Do not iron.

WARNING:

1. To avoid creating a possible strangulation hazard for children, the corded internal window covering must be installed in such a way that a loose cord cannot form a loop 220mm or longer at a height of less than 1600mm above floor level.
2. A cord guide may be installed lower than 1600mm above floor level if the cord is sufficiently secured or tensioned to prevent a loop 220mm or longer from being formed.
3. If a cord guide is installed lower than 1600mm above floor level it must be designed to prevent a child from being able to remove the cord.
4. If a cleat is used to secure the cord it must be at least 1600mm above floor level because a child is capable of unwinding a cord from a cleat.