



RLT36BS
RLT36X20



IMPORTANT!

It is essential that you read the instructions in this manual before assembling, operating, and maintaining the product.

Subject to technical modification.

Safety, performance, and dependability have been given top priority in the design of your cordless line trimmer.

INTENDED USE

The cordless line trimmer is intended for cutting long grass, pulpy weed, and similar vegetation at or about ground level.

The cutting plane should be approximately parallel to the ground surface.

The product is intended to be used only by adults who have read and understood the instructions and warnings in this manual and can be considered responsible for their actions.

The product is intended only for outdoor use in a well-ventilated area. For safety reasons, the product must be adequately controlled by a two-handed operation.

Do not use the product for any other purpose.

GENERAL PRODUCT SAFETY WARNINGS

⚠ WARNING! Read all safety warnings, instructions, illustrations and specifications provided with this power tool. Failure to follow all instructions listed below may result in electric shock, fire and/or serious injury.

Save all warnings and instructions for future reference.

The term "power tool" in the warnings refers to your mains-operated (corded) product or battery-operated (cordless) product.

WORK AREA SAFETY

- **Keep work area clean and well lit. Cluttered or dark areas invite accidents.**
- **Do not operate power tools in explosive atmospheres, such as in the presence of flammable liquids, gases or dust. Power tools create sparks which may ignite the dust or fumes.**
- **Keep children and bystanders away while operating a power tool. Distractions can cause you to lose control.**

ELECTRICAL SAFETY

- **Power tool plugs must match the outlet. Never modify the plug in any way. Do not use any adapter plugs with earthed (grounded) power tools.** Unmodified plugs and matching outlets will reduce risk of electric shock.
- **Avoid body contact with earthed or grounded surfaces, such as pipes, radiators, ranges and refrigerators.** There is an increased risk of electric shock if your body is earthed or grounded.
- **Do not expose power tools to rain or wet conditions.** Water entering a power tool will increase the risk of electric shock.
- **Do not abuse the cord. Never use the cord for carrying, pulling or unplugging the power tool. Keep cord away from heat, oil, sharp edges or moving**

parts. Damaged or entangled cords increase the risk of electric shock.

- **When operating a power tool outdoors, use an extension cord suitable for outdoor use.** Use of a cord suitable for outdoor use reduces the risk of electric shock.
- **If operating a power tool in a damp location is unavoidable, use a residual current device (RCD) protected supply.** Use of an RCD reduces the risk of electric shock.

PERSONAL SAFETY

- **Stay alert, watch what you are doing and use common sense when operating a power tool. Do not use a power tool while you are tired or under the influence of drugs, alcohol or medication.** A moment of inattention while operating power tools may result in serious personal injury.
- **Use personal protective equipment. Always wear eye protection.** Protective equipment such as dust mask, non-skid safety shoes, hard hat or hearing protection used for appropriate conditions will reduce personal injuries.
- **Prevent unintentional starting. Ensure the switch is in the off-position before connecting to power source and/or battery pack, picking up or carrying the tool.** Carrying power tools with your finger on the switch or energising power tools that have the switch on invites accidents.
- **Remove any adjusting key or wrench before turning the power tool on.** A wrench or a key left attached to a rotating part of the power tool may result in personal injury.
- **Do not overreach. Keep proper footing and balance at all times.** This enables better control of the power tool in unexpected situations.
- **Dress properly. Do not wear loose clothing or jewellery. Keep your hair and clothing away from moving parts.** Loose clothes, jewellery or long hair can be caught in moving parts.
- **If devices are provided for the connection of dust extraction and collection facilities, ensure these are connected and properly used.** Use of dust collection can reduce dust-related hazards.
- **Do not let familiarity gained from frequent use of tools allow you to become complacent and ignore tool safety principles.** A careless action can cause severe injury within a fraction of a second.

POWER TOOL USE AND CARE

- **Do not force the power tool. Use the correct power tool for your application.** The correct power tool will do the job better and safer at the rate for which it was designed.
- **Do not use the power tool if the switch does not turn it on and off.** Any power tool that cannot be controlled with the switch is dangerous and must be repaired.
- **Disconnect the plug from the power source and/or remove the battery pack, if detachable, from the power tool before making any adjustments, changing accessories, or storing power tools.** Such preventive safety measures reduce the risk of starting the power tool accidentally.
- **Store idle power tools out of the reach of children**

and do not allow persons unfamiliar with the power tool or these instructions to operate the power tool. Power tools are dangerous in the hands of untrained users.

- **Maintain power tools and accessories. Check for misalignment or binding of moving parts, breakage of parts and any other condition that may affect the power tool's operation. If damaged, have the power tool repaired before use.** Many accidents are caused by poorly maintained power tools.
- **Keep cutting tools sharp and clean.** Properly maintained cutting tools with sharp cutting edges are less likely to bind and are easier to control.
- **Use the power tool, accessories and tool bits etc. in accordance with these instructions, taking into account the working conditions and the work to be performed.** Use of the power tool for operations different from those intended could result in a hazardous situation.
- **Keep handles and grasping surfaces dry, clean and free from oil and grease.** Slippery handles and grasping surfaces do not allow for safe handling and control of the tool in unexpected situations.

BATTERY TOOL USE AND CARE

- **Recharge only with the charger specified by the manufacturer.** A charger that is suitable for one type of battery pack may create a risk of fire when used with another battery pack.
- **Use power tools only with specifically designated battery packs.** Use of any other battery packs may create a risk of injury and fire.
- **When battery pack is not in use, keep it away from other metal objects, like paper clips, coins, keys, nails, screws or other small metal objects, that can make a connection from one terminal to another.** Shorting the battery terminals together may cause burns or a fire.
- **Under abusive conditions, liquid may be ejected from the battery; avoid contact. If contact accidentally occurs, flush with water. If liquid contacts eyes, additionally seek medical help.** Liquid ejected from the battery may cause irritation or burns.
- **Do not use a battery pack or tool that is damaged or modified.** Damaged or modified batteries may exhibit unpredictable behaviour resulting in fire, explosion or risk of injury.
- **Do not expose a battery pack or tool to fire or excessive temperature.** Exposure to fire or temperature above 130°C may cause explosion.
- **Follow all charging instructions and do not charge the battery pack or tool outside the temperature range specified in the instructions.** Charging improperly or at temperatures outside the specified range may damage the battery and increase the risk of fire.

SERVICE

- **Have your power tool serviced by a qualified repair person using only identical replacement parts.** This will ensure that the safety of the power tool is maintained.
- **Never service damaged battery packs.** Service of battery packs should only be performed by the manufacturer or authorized service providers.

GRASS TRIMMER SAFETY WARNINGS

- **Do not use the machine in bad weather conditions, especially when there is a risk of lightning.** This decreases the risk of being struck by lightning.
- **Thoroughly inspect the area for wildlife where the machine is to be used.** Wildlife may be injured by the machine during operation.
- **Thoroughly inspect the area where the machine is to be used and remove all stones, sticks, wires, bones, and other foreign objects.** Thrown objects can cause personal injury.
- **Before using the machine, always visually inspect to see that the cutter or blade and the cutter or blade assembly are not damaged.** Damaged parts increase the risk of injury.
- **Follow instructions for changing accessories.** Improperly tightened blade securing nuts or bolts may either damage the blade or result in it becoming detached.
- **Wear eye, ear, head and hand protection.** Adequate protective equipment will reduce personal injury by flying debris or accidental contact with the cutting line or blade.
- **While operating the machine, always wear non-slip and protective footwear. Do not operate the machine when barefoot or wearing open sandals.** This reduces the chance of injury to the feet from contact with the moving cutters or lines.
- **While operating the machine, always wear long trousers.** Exposed skin increases the likelihood of injury from thrown objects.
- **Keep bystanders away while operating the machine.** Thrown debris can result in serious personal injury.
- **Always use two hands when operating the machine.** Holding the machine with both hands will avoid loss of control.
- **Hold the machine by the insulated gripping surfaces only, because the cutting line or blade may contact hidden wiring.** Cutting line or blades contacting a "live" wire may make exposed metal parts of the machine "live" and could give the operator an electric shock.
- **Always keep proper footing and operate the machine only when standing on the ground.** Slippery or unstable surfaces may cause a loss of balance or control of the machine.
- **Do not operate the machine on excessively steep slopes.** This reduces the risk of loss of control, slipping and falling which may result in personal injury.
- **When working on slopes, always be sure of your footing, always work across the face of slopes, never up or down and exercise extreme caution when changing direction.** This reduces the risk of loss of control, slipping and falling which may result in personal injury.
- **Keep all parts of the body away from the cutter, line or blade when the machine is operating. Before you start the machine, make sure the cutter, line or blade is not contacting anything.** A moment of inattention while operating the machine may result in injury to yourself or others.
- **Do not operate the machine above waist height.** This helps prevent unintended cutter or blade contact

and enables better control of the machine in unexpected situations.

- **When cutting brush or saplings that are under tension, be alert for spring back.** When the tension in the wood fibres is released, the brush or sapling may strike the operator and/or throw the machine out of control.
- **Use extreme caution when cutting brush and saplings.** The slender material may catch the blade and be whipped toward you or pull you off balance.
- **Maintain control of the machine and do not touch cutters, lines or blades and other hazardous moving parts while they are still in motion.** This reduces the risk of injury from moving parts.
- **Carry the machine with the machine switched off and away from your body. Proper handling of the machine will reduce the likelihood of accidental contact with a moving cutter, line or blade.**
- **Only use replacement cutters, lines, cutting heads and blades specified by the manufacturer.** Incorrect replacement parts may increase the risk of breakage and injury.
- **When clearing jammed material or servicing the machine, make sure the switch is off and the battery pack is removed.** Unexpected starting of the machine while clearing jammed material or servicing may result in serious personal injury.

ADDITIONAL SAFETY WARNINGS

- Before use and after any impact, check that there are no damaged parts on the product. A defective switch or any part that is damaged or worn should be properly repaired or replaced by an authorised service centre.
- The small blade fitted to the safety guard is designed to trim the newly extended line to the correct length for safe and optimum performance. The blade is very sharp. Do not touch the blade, particularly when cleaning the product.
- Use only the manufacturer's replacement cutting line. Do not use any other cutting attachment.
- Make sure that the cutting attachment is properly installed and securely fastened.
- Never operate the product unless all guards, deflectors, and handles are properly and securely attached.
- Ensure that the line cut-off blade in the guard is properly positioned and secured before each use.
- Keep the head attachment below waist level.
- Immediately turn off the product and remove the battery pack in the event of an accident or a breakdown. Do not operate the product again until it has been fully checked by an authorised service centre.
- To reduce the risk of injury associated with contacting moving parts, always turn off the product, remove the battery pack, and allow both to cool down. Make sure that all moving parts have come to a complete stop:
 - before servicing
 - before clearing a blockage
 - before checking, cleaning, and working on the product
 - before changing accessories
 - after striking a foreign object

- whenever leaving the product unattended
- whenever performing maintenance
- whenever the product starts to vibrate abnormally
- Ensure that all guards and handles are properly fitted and are in good condition.
- Hold the product by designated handles, and restrict working time and exposure.
- Beware of objects thrown by the cutting means. Clear debris like small stones, gravel, and other foreign objects from the work area before starting operation. Wires or string may become entangled with the cutting means.
- Always ensure that ventilation openings are kept clear of debris.
- Injuries may be caused, or aggravated, by prolonged use of the product. When using the product for prolonged periods, ensure that you take regular breaks.
- Operate the product only in temperatures between 0°C and 40°C.
- Store the product in a location where the ambient temperature is between 0°C and 40°C.

ADDITIONAL BATTERY SAFETY WARNINGS

To reduce the risk of fire, personal injury, and product damage due to a short circuit, never immerse the product, battery pack, or charger in fluid or allow fluid to flow inside them. Corrosive or conductive fluids, such as seawater, certain industrial chemicals, and bleach or bleach-containing products, etc., can cause a short circuit.

- Charge the battery pack in a location where the ambient temperature is between 10°C and 38°C.
- Store the battery pack in a location where the ambient temperature is between 0°C and 20°C.
- Use the battery pack in a location where the ambient temperature is between 0°C and 40°C.

TRANSPORTATION AND STORAGE

- Turn off the product, remove the battery pack, and allow both to cool down before storing or transporting.
- Remove all foreign materials from the product.
- Do not store or transport the product with the battery pack fitted. Remove the battery pack, and secure it separately. Store the product in a cool, dry, and well-ventilated place that is inaccessible to children. Keep the product away from corrosive agents, such as garden chemicals and de-icing salts. Do not store the product outdoors.
- For transportation in vehicles, secure the product against movement or falling to prevent injury to persons or damage to the product.

TRANSPORTING LITHIUM BATTERIES

- Transport the battery pack in accordance with local and national provisions and regulations.
- Follow all special requirements on packaging and labelling when transporting batteries by a third party. Ensure that no batteries can come in contact with other batteries or conductive materials while in transport by protecting exposed connectors with insulating, non-conductive caps or tape. Do not transport batteries that are cracked or leaking. Check with the forwarding company for further advice.

MAINTENANCE

- Use only original manufacturer's replacement parts, accessories, and attachments. Failure to do so can cause possible injury, can contribute to poor performance, and may void your warranty.
- Servicing requires extreme care and knowledge and should be performed only by a qualified service technician. Have the product serviced by an authorised service centre only.
- Turn off the product and remove the battery pack before conducting any maintenance or cleaning work.
- You may make adjustments or repairs described in this manual. For other repairs, contact an authorised service centre.
- For the replacement line, use only a nylon filament line of the diameter described in the specifications table of this manual.
- After each use, clean the product with a soft, dry cloth. Any part that is damaged should be properly repaired or replaced by an authorised service centre.
- Check all nuts, bolts, and screws before each use and at frequent intervals for proper tightness to ensure that the product is in safe working condition. Any part that is damaged should be properly repaired or replaced by an authorised service centre.
- Bring the product to an authorised service centre to replace damaged or unreadable labels.

SYMBOLS ON THE PRODUCT



Safety alert



Read and understand all instructions before operating the product. Follow all warnings and safety instructions.



Wear eye and ear protection.



Wear non-slip safety footwear when using the product.



Wear non-slip, heavy-duty gloves.



Do not use metal blade(s) on the product.



Beware of thrown or flying objects. Keep all bystanders, especially children and pets, at least 15 m away from the operating area.



Remove the battery pack before starting any work on the product.



Do not expose the product to rain or damp conditions.



Keep hands away from the cut-off blade.



Rotational direction and maximum speed of the shaft for the cutting attachment.



Guaranteed sound power level



Regulatory Compliance Mark (RCM). Product meets applicable regulatory requirements.



Waste electrical products should not be disposed of with household waste. Please recycle where facilities exist. Check with your local authority or retailer for recycling advice.

SYMBOLS IN THIS MANUAL



Parts or accessories sold separately



Note



Warning

RLT36BS

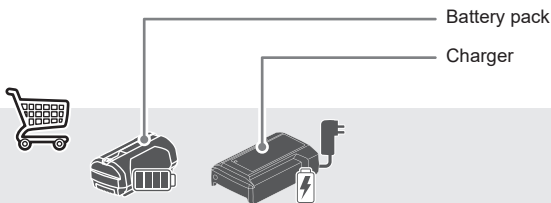
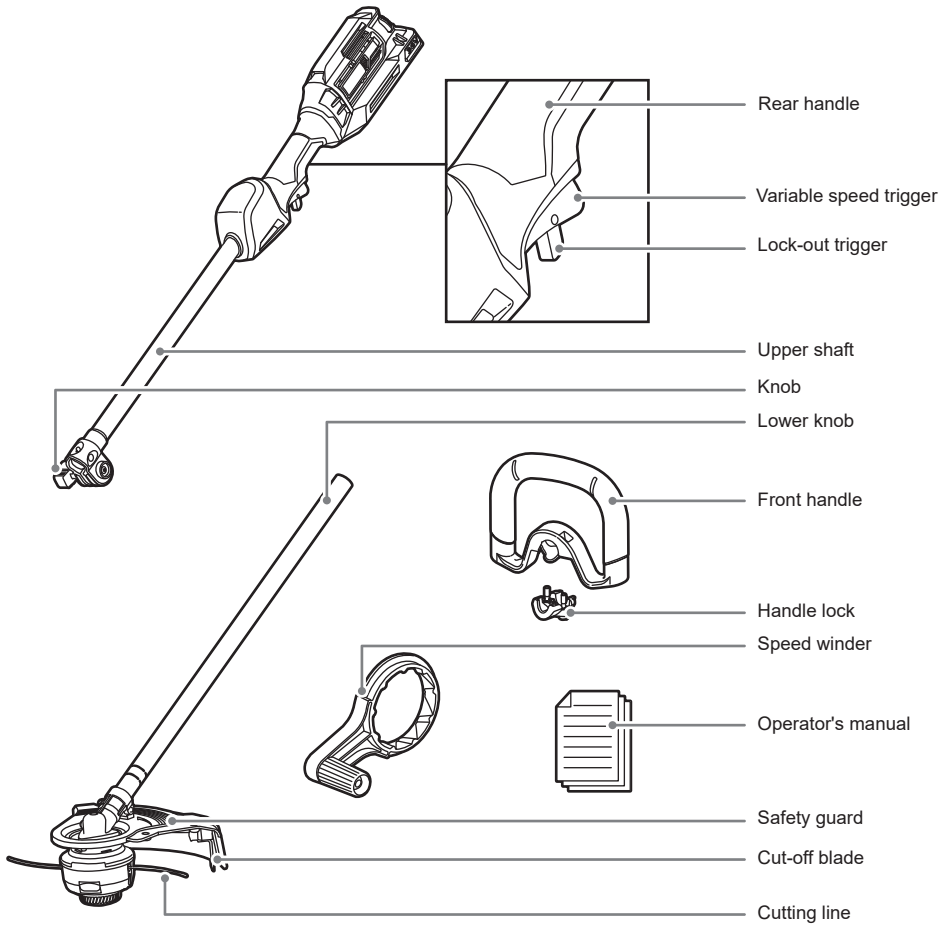

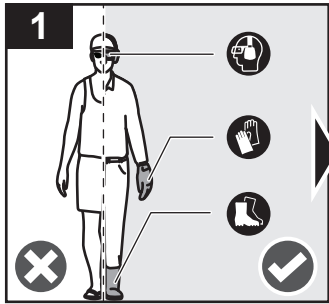

Always wear safety goggles or safety glasses with side shields when operating the product. Wear non-slip, heavy-duty protective gloves. Wear non-skid, protective footwear that will protect your feet and improve your footing on slippery surfaces.

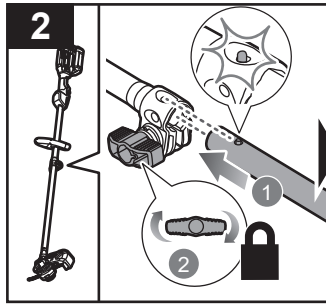

Insert the lower shaft to the upper shaft. Tighten the knob to secure the drive shafts.

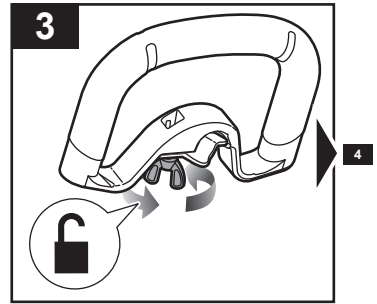

Loosen the handle lock.

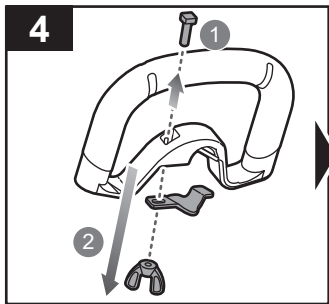

Remove the handle lock from the front handle.

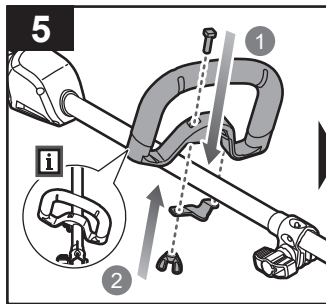

Install the front handle. Re-insert the handle lock to secure the front handle.

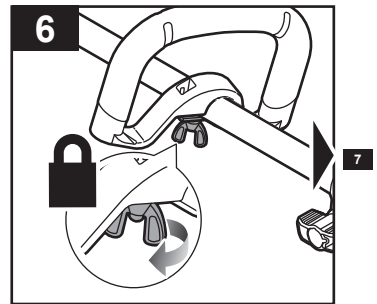

Tighten the handle lock to secure the front handle in place.

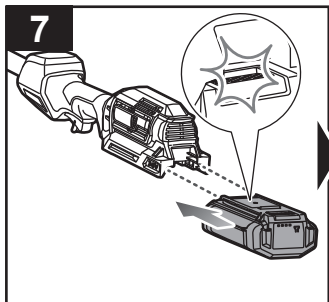

Install the battery pack until the latch clicks into place.

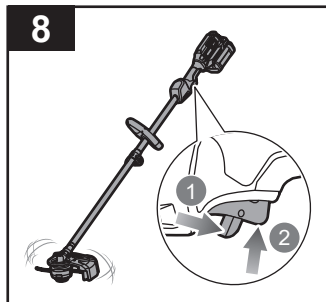

Hold the lock-out trigger, and squeeze the variable speed trigger to operate the product.

Operating the product **p.9**



Adjusting the cutting width **p.11**

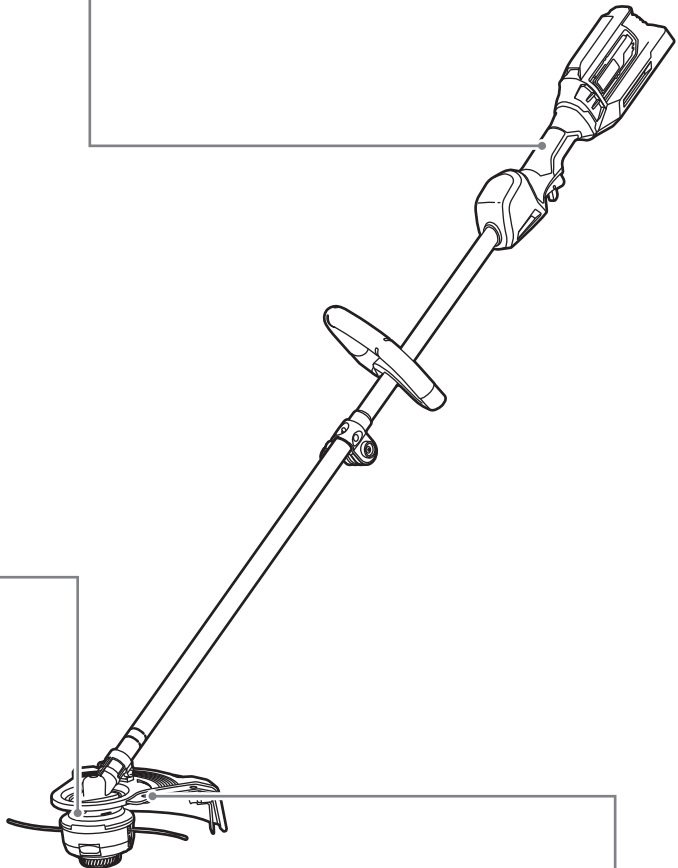
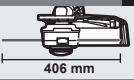

Replacing the cutting line **p.12**

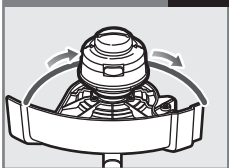

Replacing the spool **p.14**

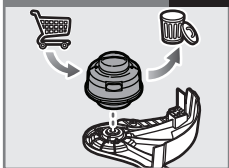

Cleaning the product **p.15**

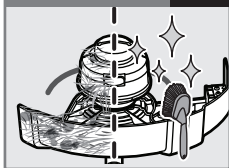

Storing the product **p.16**

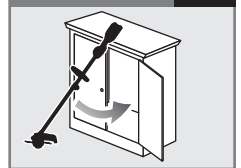

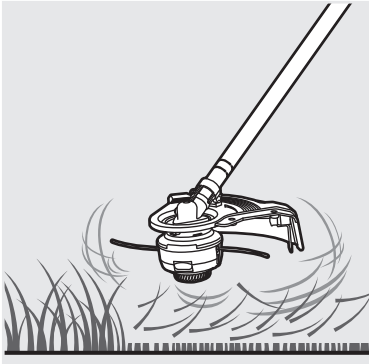

OPERATING THE PRODUCT

WARNING: For safety reasons, the product must be adequately controlled by a two-handed operation. Hold the product with the right hand on the rear handle and the left hand on the front handle.

WARNING: Consider the environment in which you are working. Keep the working area free from wires, sticks, stones, and debris, which if struck by the cutter can become thrown objects.

WARNING: Exercise extreme caution when using the product. Keep hands and feet away from the cutting means at all times, especially when turning on the motor.

1. Insert the battery pack until the latch clicks into place.
2. Turn on the lock-out trigger, and squeeze the variable speed trigger to turn on the product.

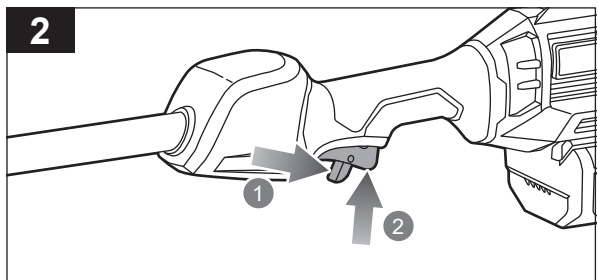
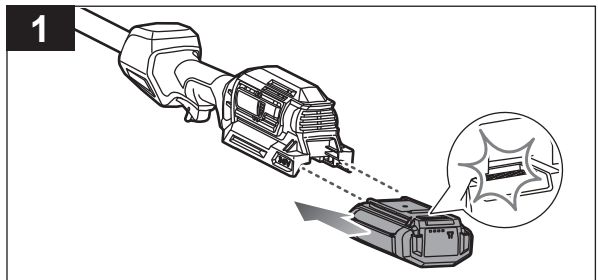
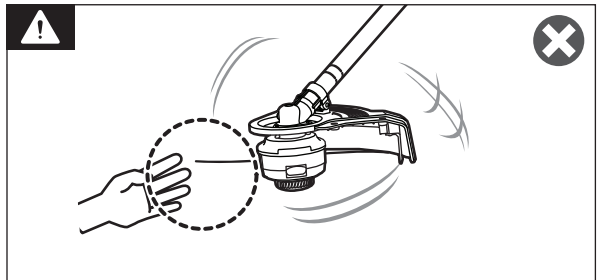
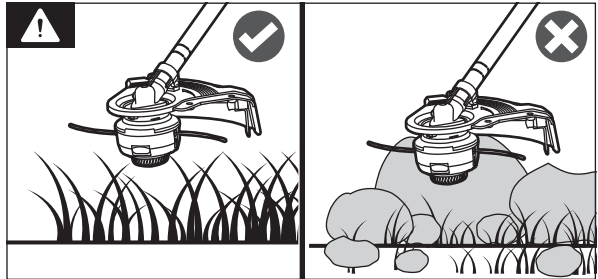
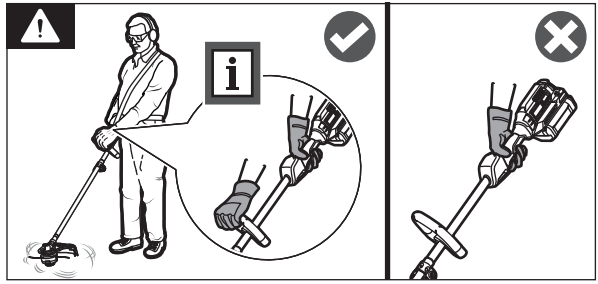

3. Tap the bump knob on the ground to advance the line. The line advances each time the bump knob is tapped. Do not hold the bump knob onto the ground.

NOTE: Tap the bump knob only on grass to prevent damage to the bump knob.

NOTE: The small blade fitted to the safety guard is designed to trim the newly extended line to the correct length for safe and optimum performance. The blade is very sharp. Do not touch the blade, particularly when cleaning the product.

NOTE: Cut tall grass from the top down. This prevents grass from wrapping around the shaft housing and bump head, which may cause damage from overheating.

NOTE: Cut grass from the right side to the left side for cutting ease and safety.

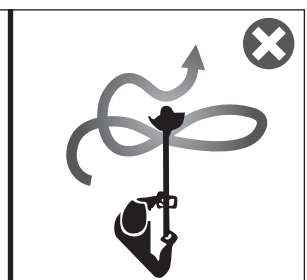
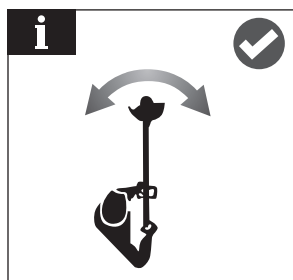
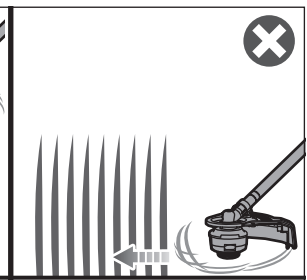
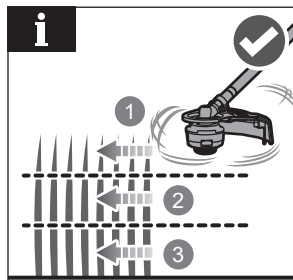
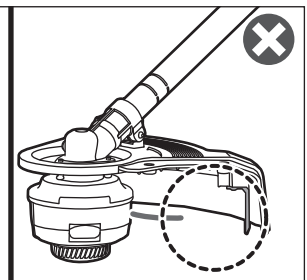
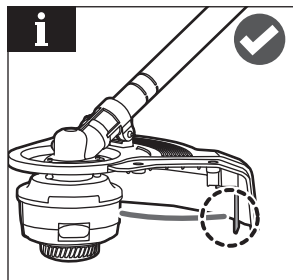
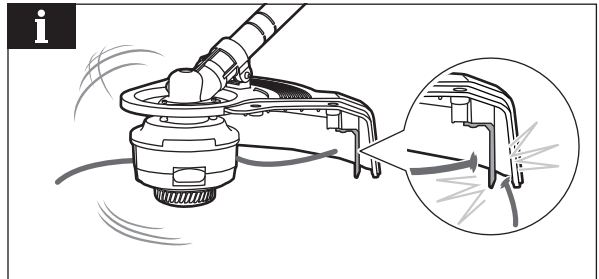
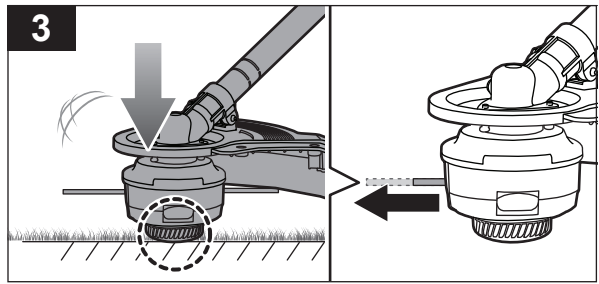

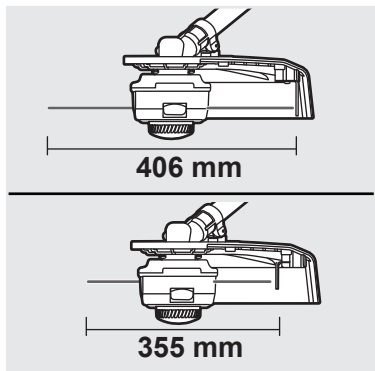

ADJUSTING THE CUTTING WIDTH

1. Remove the battery pack.
2. Place the product on a level surface. Position the product with the motor side down and the blade guard side up.
3. Remove the screws on the line cut-off blade. Remove the blade. Rotate the blade 180°.
4. Install the blade. Tighten the screws to secure the blade into the new position.

NOTE: The cutting width of the line trimmer can be adjusted according to preference. A cutting width of 38 cm gets the job done faster but results in a lesser runtime.

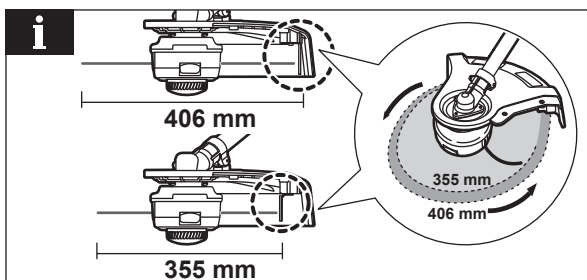
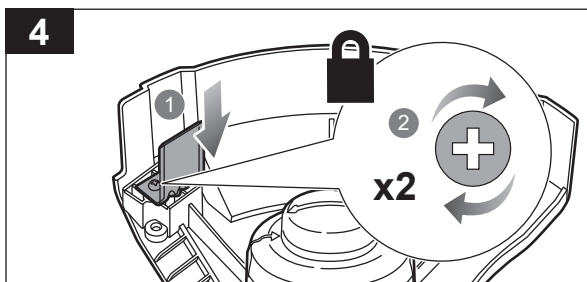
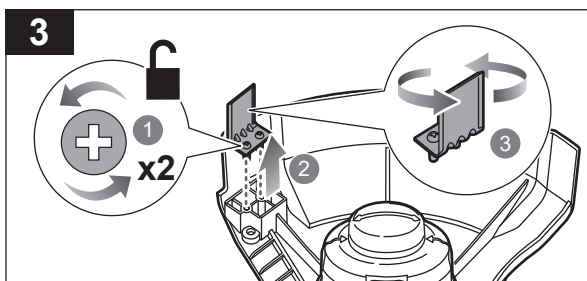
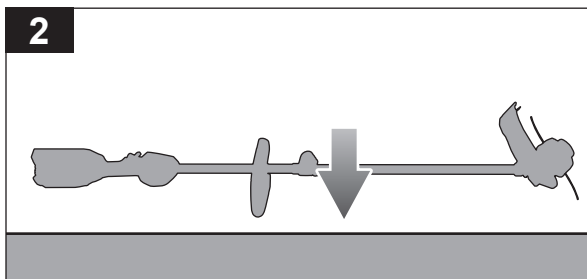
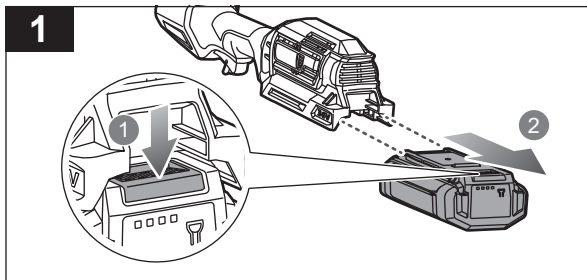

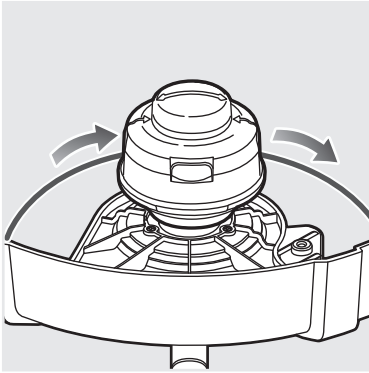

REPLACING THE CUTTING LINE

1. Press the battery latch button, and remove the battery pack.
2. Place the product on a level surface. Position the product with the motor side down and the blade guard side up.
3. Rotate the bump knob on the spool until the line on the centre of the bump knob aligns with the arrows on the outer spool.
4. Use a 2.0 mm diameter line. Cut one piece of the line, approximately 3.0 m in length. Insert one end of the line through the eyelet on the side of the spool, and push the line until it comes out through the eyelet on the other side. Continue to push the line through the spool until the line is even in length on both sides.
5. Ensure that there are equal lengths of line on either side of the spool (max. 1.65 m per side). Rotate the bump knob with the speed winder to wind the line.

NOTE: The bump knob can also be rotated by hand.

NOTE: When reloading, the line length should be maximum of 2.6 m each side.

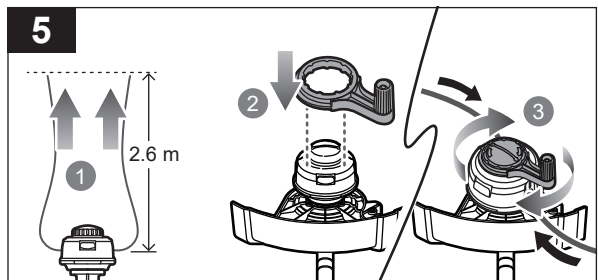
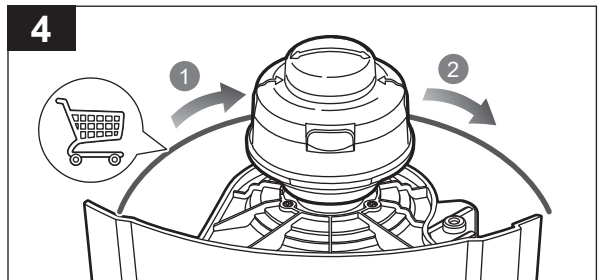
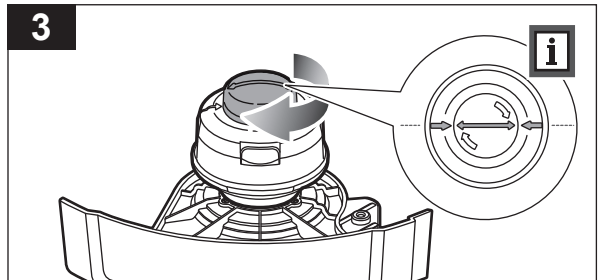
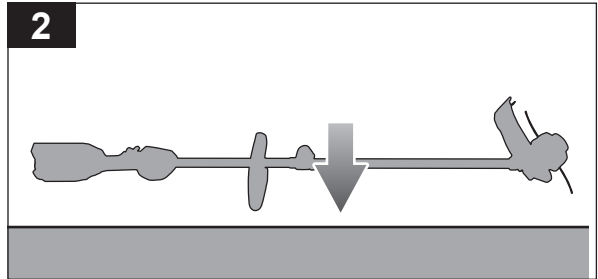
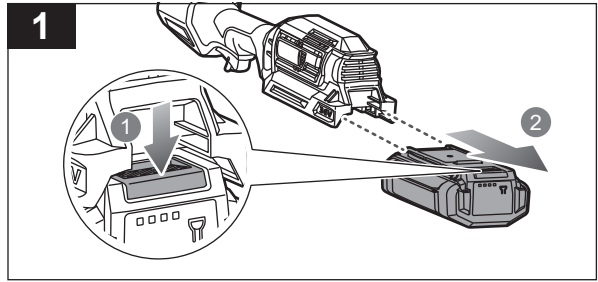

NOTE: Wind the line until approximately 12 cm remains protruding from the trimmer head.

6. Insert the battery pack until the latches click into place.
7. Press and hold the lock-out trigger, and squeeze the on/off trigger to operate the product.
8. Tap the bump knob on the ground to advance the line. The line advances each time the bump knob is tapped. Do not hold the bump knob onto the ground.

NOTE: Tap the bump knob only on grass to prevent damage to the bump knob.

NOTE: The small blade fitted to the safety guard is designed to trim the newly extended line to the correct length for safe and optimum performance. The blade is very sharp. Do not touch the blade, particularly when cleaning the product.

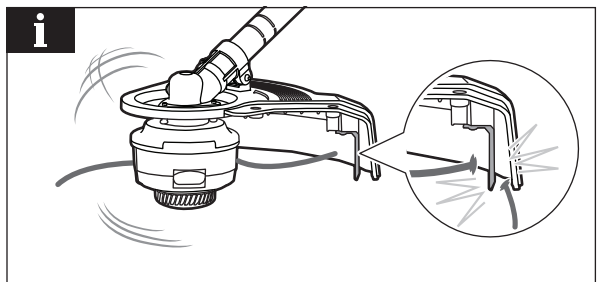
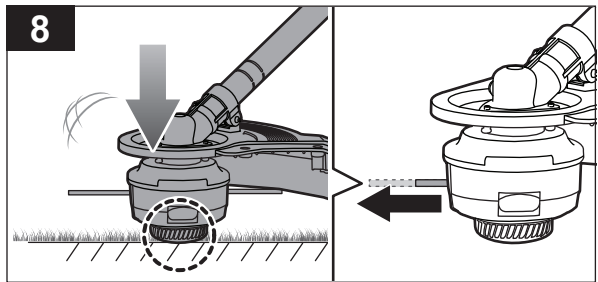
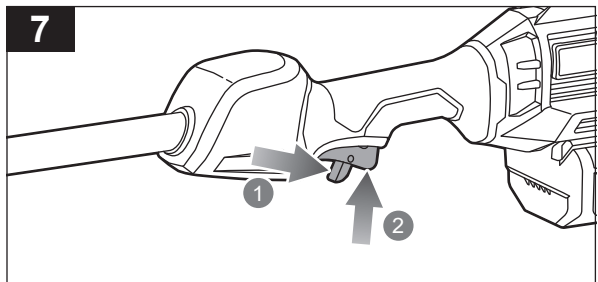
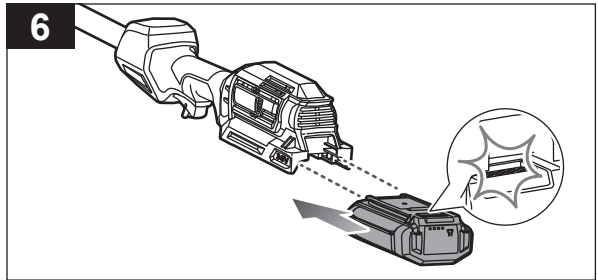
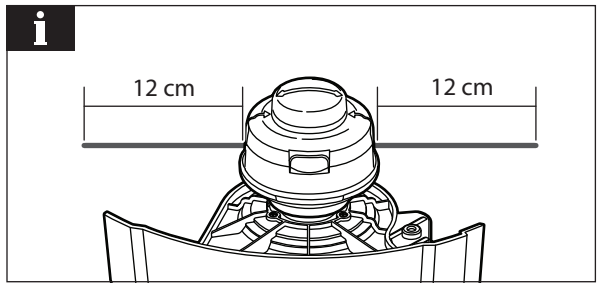

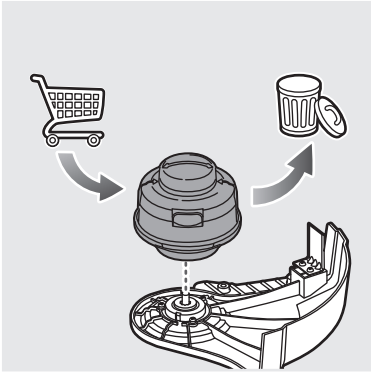

REPLACING THE SPOOL

1. Press the battery latch button, and remove the battery pack.
2. Place the product on a level surface. Position the product with the motor side down and the blade guard side up.
3. Insert the lock pin into the slot underneath the spool. Loosen and remove the trimmer head.
4. Install the new spool. Tighten the spool to secure.
5. Remove the lock pin.

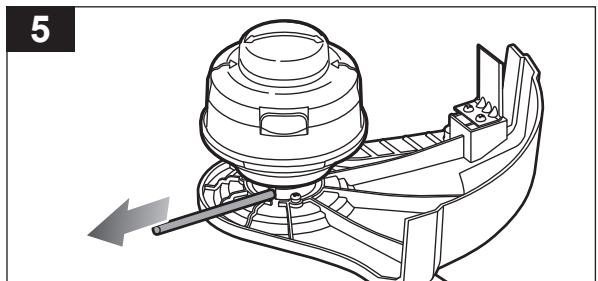
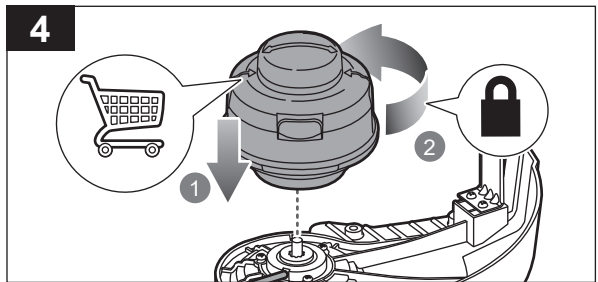
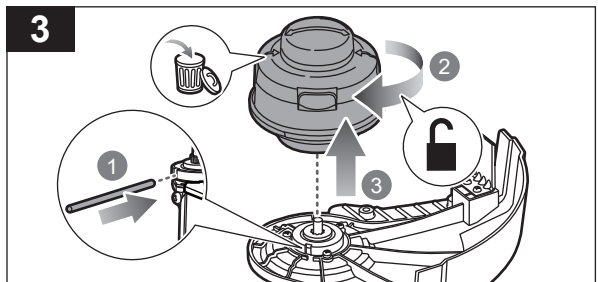
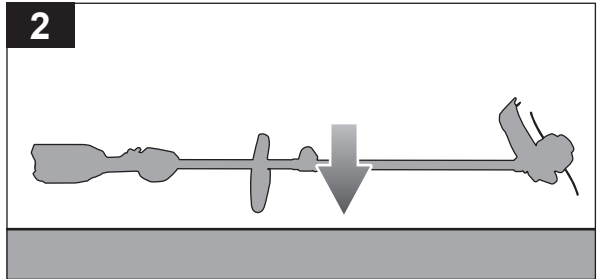
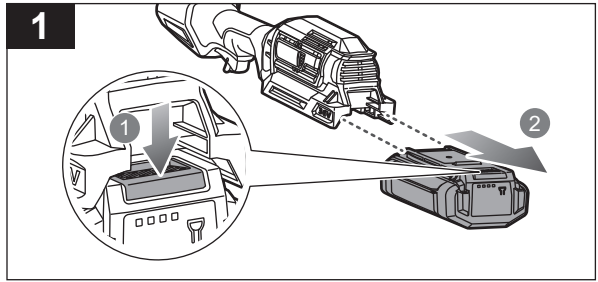

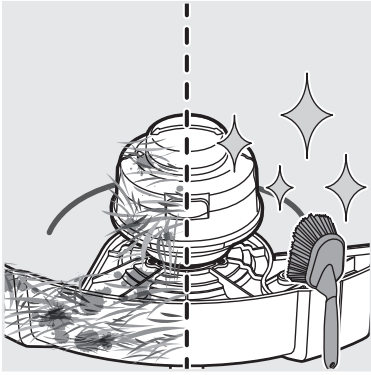

CLEANING THE PRODUCT

1. Press the battery latch button, and remove the battery pack.
2. Place the product on a level surface. Position the product with the motor side down and the blade guard side up.

WARNING: The small blade fitted to the safety guard is designed to trim the new extended line to the correct length for safe and optimum performance. The blade is very sharp. Do not touch the blade, particularly when cleaning the product.

3. Clean the product with a soft, dry brush.

WARNING: Avoid using solvents when cleaning plastic parts. Most plastics are susceptible to damage from various types of commercial solvents and may be damaged by their use.

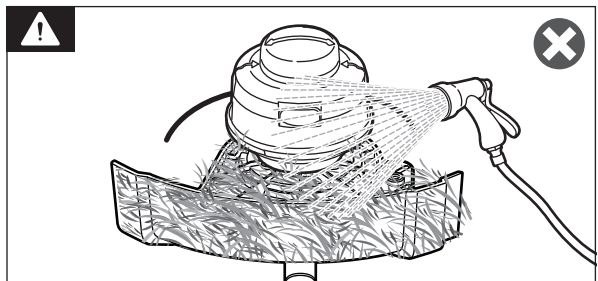
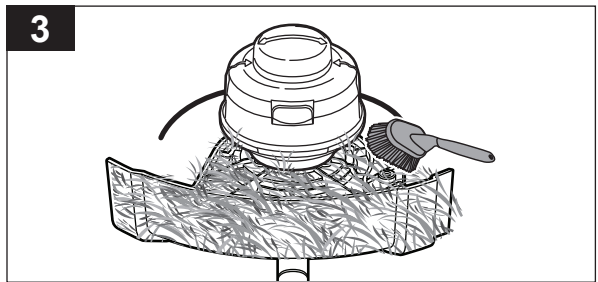
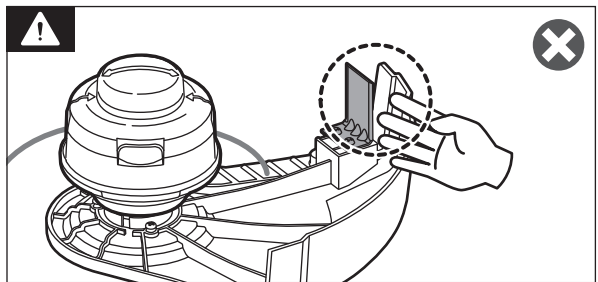
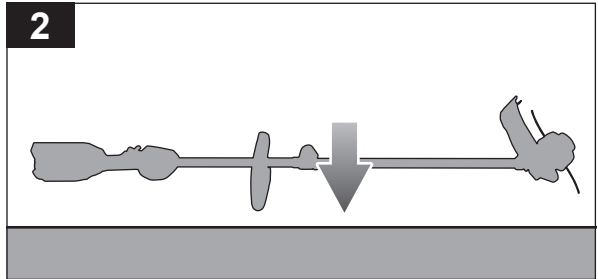
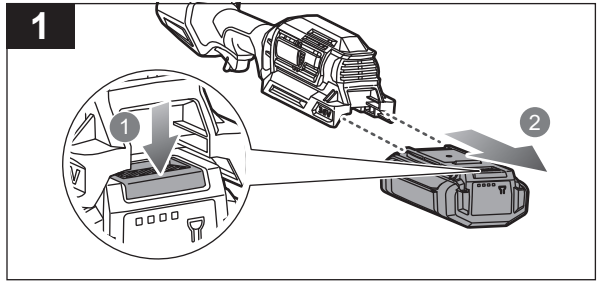

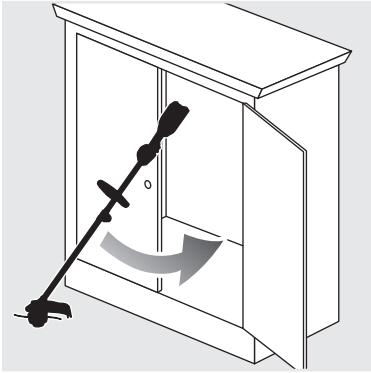

STORING THE PRODUCT

NOTE: Clean the product before storing it.

1. Remove the battery pack.
2. Store the product in a cool, dry, and well-ventilated place that is inaccessible to children. Keep the product away from corrosive agents, such as garden chemicals and de-icing salts. Do not store the product outdoors.

NOTE: Use the hanger cap to hang and store the product upright.

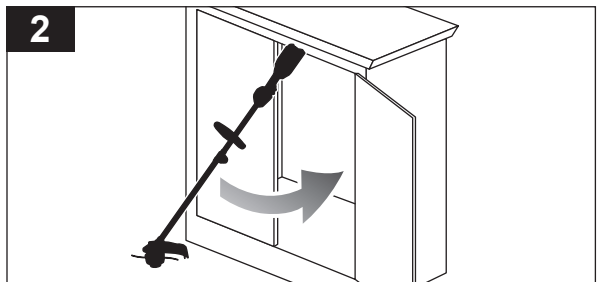
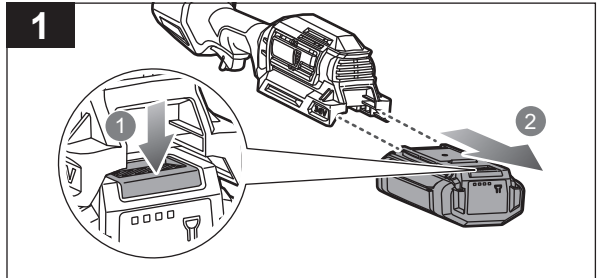
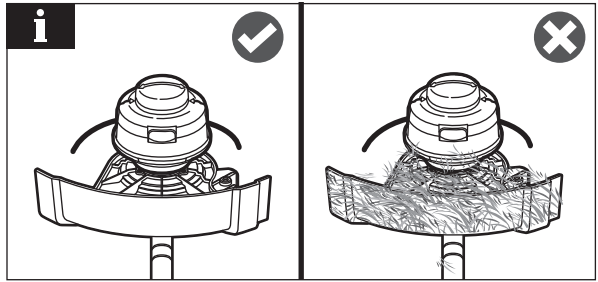

PRODUCT SPECIFICATIONS

Cordless line trimmer according to grass trimmer requirements

Model RLT36BS

Voltage 36 V d.c

No-load speed

Cut swath: 280 mm 5,600/min

Cut swath: 330 mm 5,500/min

Cutting capacity 330 mm / 280 mm

Cutting line diameter 2.0 mm

Weight without battery pack 4.0 kg

Vibration level (in accordance with IEC 62841-4-4)

Front handle $a_h = 7.0 \text{ m/s}^2$

Rear handle $a_h = 6.7 \text{ m/s}^2$

Uncertainty $K = 1.5 \text{ m/s}^2$

Noise emission level (in accordance with IEC 62841-4-4)

A-weighted sound pressure level $L_{pA} = 83.8 \text{ dB(A)}$

Uncertainty $K_{pA} = 3.0 \text{ dB}$

A-weighted sound power level $L_{WA} = 93.7 \text{ dB(A)}$

Uncertainty $K_{WA} = 3.0 \text{ dB}$

$L_{WA} + K_{WA} = 97 \text{ dB(A)}$

BATTERY AND CHARGER

Model RLT36X20 RLT36BS

Battery pack R36BTY2 —

Charger BCL3617S —

Compatible battery packs BPL3626, BPL3640, BPL3620D,
BPL3626D, BPL3640D, BPL3650D,
BPL3626D2, BPL3650D2, BPL3640D2,
R36BTY2, R36BTY4

REPLACEMENT PART

Complete spool RAC1214

Line replacement PWFTL2015T - PWFTL2050T

NOTE: Visit your local special orders desk or contact RYOBI customer service for replacement parts.

⚠ WARNING! The declared vibration total values and the declared noise emission values given in this instruction manual have been measured in accordance with a standardised test and may be used to compare one tool with another. They may be used for a preliminary assessment of exposure.

The declared vibration and noise emission values represent the main applications of the tool. However, if the tool is used for different applications, used with different accessories, or poorly maintained, the vibration and noise emission may differ. These conditions may significantly increase the exposure levels over the total working period.

An estimation of the level of exposure to vibration and noise should take into account the times when the tool is turned off or when it is running idle. These conditions may significantly reduce the exposure level over the total working period.

Identify additional safety measures to protect the operator from the effects of vibration and noise, such as maintaining the tool and the accessories, keeping the hands warm (in case of vibration), and organising work patterns.





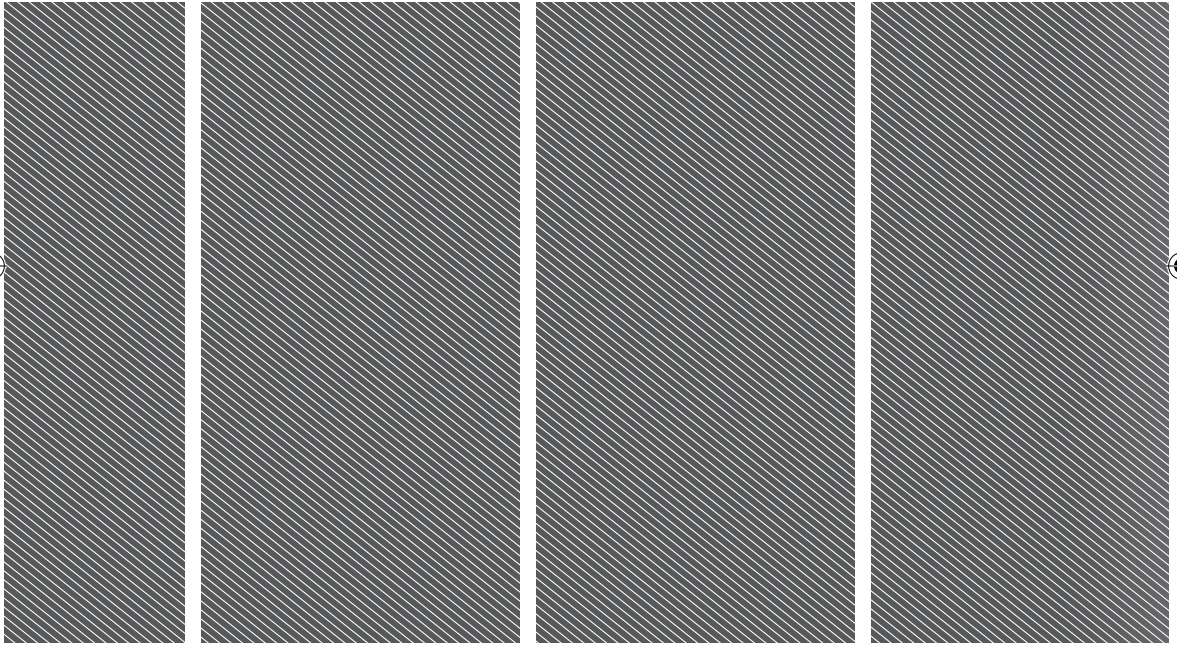

Imported by:
Techtronic Industries Australia Pty Ltd
31 Gilby Road, Mount Waverley, VIC 3149
Melbourne, Australia

Techtronic Industries N.Z. Limited
Unit C, 70 Business Parade South,
Highbrook, Auckland 2013, New Zealand

RYOBI is a trade mark of Ryobi Limited, and is used under license.

961087382-02

