

▲ WARNING Falling on the top of the fence may cause serious injury. No representation or warranty is given that your particular application of these products complies with relevant building codes. Consult with professionals and local building officials before beginning work: (i) to ensure compliance with relevant building codes for your application; (ii) to identify appropriate safety gear used during installation; (iii) to ensure that the work area is free from utilities, services and hazards; and (iv) to clarify any instructions or warnings that may not be clear. Inspect and maintain these products on a regular basis. Neither Peak Products Pty Limited nor Peak Products Corporation shall be liable for any loss or damage resulting from the improper installation or improper use of this product, subject to any contrary provision of the Australian Consumer Law in Australia or the Consumer Guarantees Act in New Zealand.

Peak products and associated materials are protected by patents, designs, copyrights and/or trademarks.

Fence Panel Installation

1 Measure and mark the position of all posts and use a string line to ensure they are aligned. Then lay the fence panels flat along the string line with the mesh oriented on the same side of the panel. Start at an end, corner, or gate. For installation on sloped surfaces, start at the highest point.

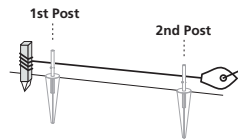

2 A: Remove pin and separate post from spike. Position the first spike and hammer it into the ground until the top plate is flush with the surface.

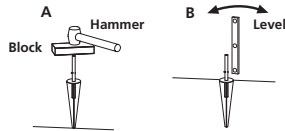

B: Use a level to ensure the spike is plumb.

3 A: Insert the first post down through the fence panel tabs and onto the spike. Then secure with pin (provided).

B: Insert the second post through the fence panel tabs and press the post into the soil to mark the location for the second spike.

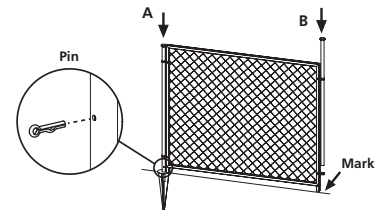

4 A: Hammer the second spike into the ground at the marked location.

B: Insert the second post through the fence panel tabs and down onto the spike. Then secure with pin (provided).

C: For installation on sloped surfaces, drill 3.5 mm pilot holes through the upper and lower panel tabs on the downhill side of the panel. Then fasten panel to post using 8G x 15mm screws (not provided).

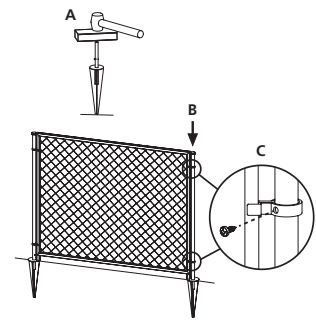

Gate Installation

1 Measure and mark the position of all posts and use a string line to ensure they are aligned. Then lay the fence panels flat along the string line with the mesh oriented on the same side of the panel. Start at an end, corner, or gate. For installation on sloped surfaces, start at the highest point.

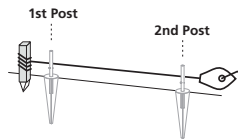

2 A: Remove pin and separate post from spike. Position the first spike and hammer it into the ground until the top plate is flush with the surface.

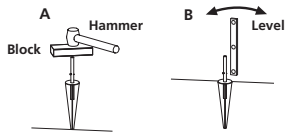

B: Use a level to ensure the spike is plumb.

3 A: Insert first post down through the gate hinges and onto the spike. Then secure with pin (provided).

B: Position latch according to swing direction. Secure latch to frame with bolts, nuts and washers (provided).

C: Determine the placement for the second spike and hammer it into the ground.

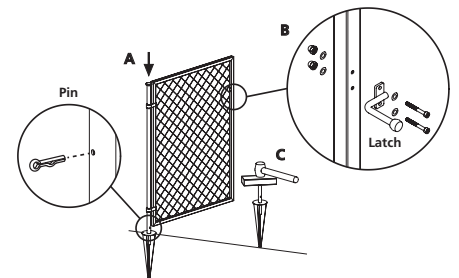

4 A: Slide catch onto second post and insert post down onto the spike. Then secure with pin (provided).

B: Position retainer to align with catch, then drill four 4 mm pilot holes through side of post. Fasten catch to post using four screws (provided).

