

# SECTOR

PANEL FENCING

SOUND / SIMPLE / FAST

## Installation Guide

Step-by-Step Guide

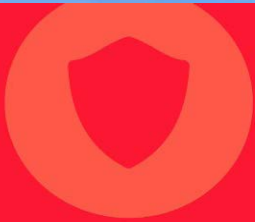

***Sound***



***Simple***



***Fast***

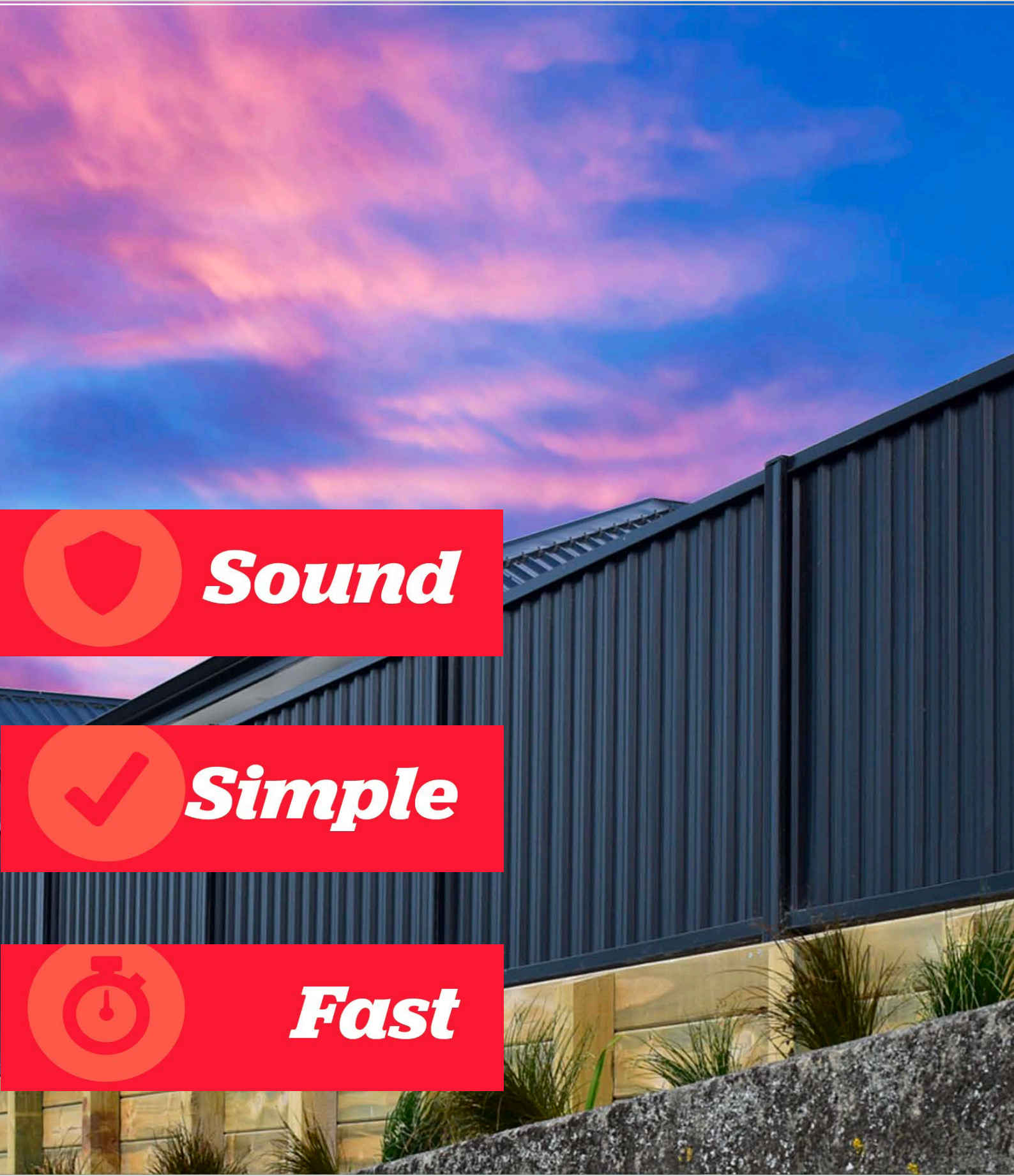

# Install Guide for Frontier and Borderline Range.

Thank you for choosing one of Sector Fencing's quality products. We are the industry leaders in designer panel fencing. This product will provide you with years of trouble free protection if installed in accordance with these directions.

## Installation Guide

The recommendations detailed in this guide produced by Sector are formulated along the lines of good building practice. They are not intended to be an exhaustive statement of all the relevant data. Further, as the success of projects depend on factors outside the control of Sector Fencing (e.g. quality of workmanship, particular design, detail requirements, etc), Sector accepts no responsibility for, or in connection with, the quality of the projects or their suitability when completed. If you are in any doubt please seek independent advice or contact Sector direct.

We are always happy and available to answer questions regarding installation no matter how small or insignificant you think they may be.

[info@sector.co.nz](mailto:info@sector.co.nz)

### IMPORTANT

It is recommended the reader pays particular attention to items identified as "IMPORTANT" in this manual to ensure a satisfactory installation and the long term performance of the products.



# Components List

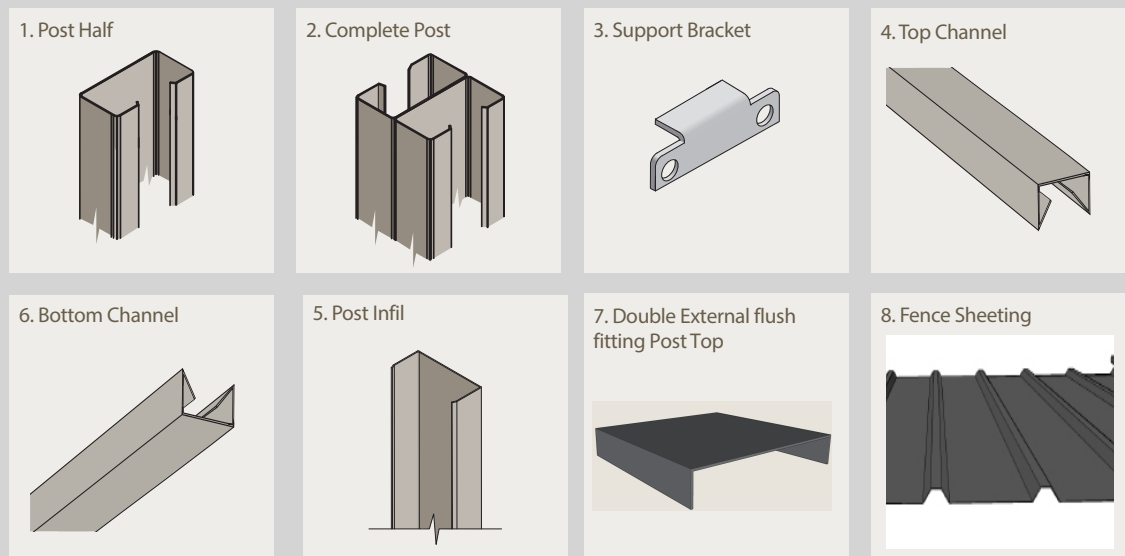

# Tools Needed



5/16" Hex Bit

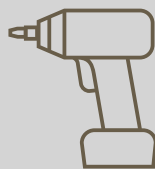

Drill/Driver

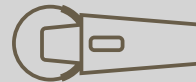

Angle Grinder

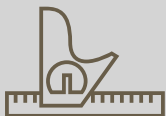

Square



Spirit Level



Shovel



Line Marking Paint

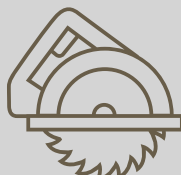

Circular Saw



Caulking Gun



String Line



Post Hole Digger



Tape Measure

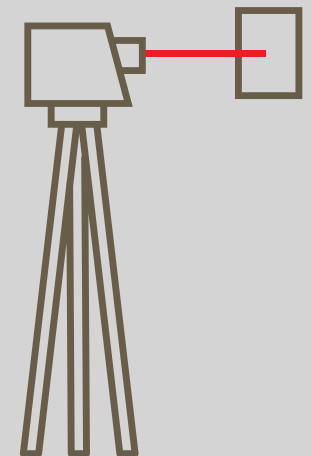

Laser Level (if you can get hold of one.)

It is recommended that you read through this guide before beginning the installation.

# Step 1

## Determine Boundary line, Posthole Depths and Centres

Please read the wind region and post hole depth charts carefully prior to starting your installation.

We recommend you plan your wall set out/post position on a piece of paper first to save unnecessary digging. Where installation is to take place on uneven or sloped ground, you should also consider the instructions listed under "Additional Information" towards the end of this guide.

Accurately determine the boundary line to where the fence will be installed & mark this with a string line as per the diagram below. In cases where the boundary line is unknown or unclear, a surveyor will need to be engaged.

**Note** The diagram below is for reference purposes only & shows the wall splitting the boundary line equally; this may not always be the case depending on your individual circumstances.

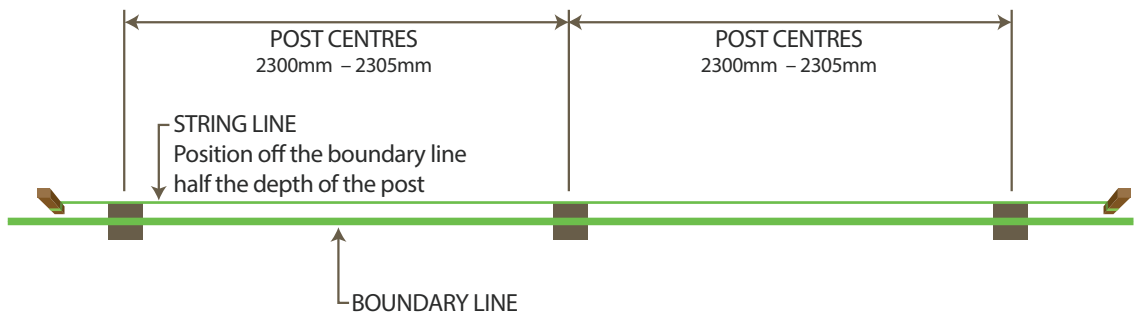

Standard Post Centre-to-Centre measurement when using a 2280mm panel will be 2300mm minimum (Plus 5mm extra is an allowable tolerance). This will give you the required clearance when installing the wall panels.

**Note:** Fence panels may be trimmed with a Angle Grinder if necessary to fit in within an exact measurement (panel cutting procedure is detailed later in this guide).

Postholes can be dug by hand or with a mechanical auger. Use the Footing depth table to determine your posthole depth and diameter.

**IMPORTANT** Recommended footing depths listed here are for terrain categories 2.5 & 3, within wind regions A & B. If you are building your wall in a Cyclonic wind area, on the top of a hill, adjacent to an escarpment, on a ridge, or in terrain category 1, you will need engineering advice beyond the scope of this publication.

Please contact Sector directly for this information.



Footing depth table

Wall Height	Hole depth into firm earth or clay		Hole depth into sand, soft clay or loose earth		Hole Diameter
	Wind regions A&B Terrain Categories 2.5 & 3	Approx. concrete required (20 kg bags)	Wind regions A&B Terrain Categories 2.5 & 3	Approx. concrete required (20 kg bags)	
900	450mm	1.5 per hole	550mm	1.5 per hole	200mm
1200	550mm	2 per hole	650mm	2 per hole	200mm
1500	600mm	2 per hole	700mm	2.5 per hole	200mm
1800	650mm	2 per hole	800mm	3 per hole	200mm

## Step 2

# Screw posts together

Post Half



Place the two halves of the post on a FLAT surface back to back, align the tops exactly and clamp if necessary.

Screw the posts together starting with a double screw at the top approx. 50mm down and then in an off-set pattern at a maximum 300mm centres from then on.

**IMPORTANT** Screw both ends together first before the centre section.



### Fastening posts together

2 fasteners approximately  
 50mm from top of post

Maximum screw spacing  
 300mm centres

10 - 16 x 16mm   
 Hex Head self drilling  
 screw placings.  
 Screws to conform  
 to AS3566 Class 3



## Step 3

# Fixing the base brackets to the post

Support Bracket

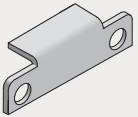

Attach the panel support bracket into the post with the hex head screws supplied.

The measurement the the bracket should be screwed on at should be 6mm more than the length of the sheeting provided.

Example if you have ordered a Frontier fence @1800 high the sheets supplied will be 1805mm long so you screw your brackets on at 1811mm.

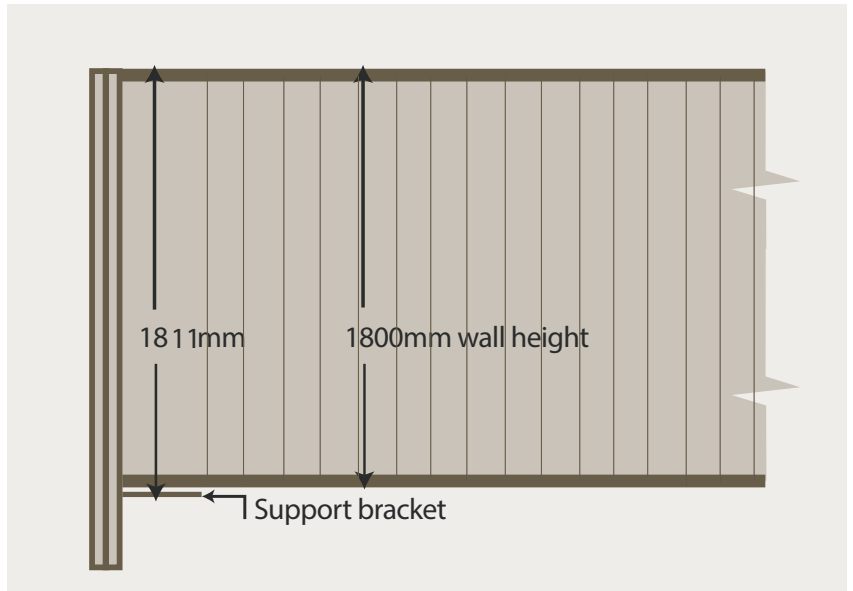
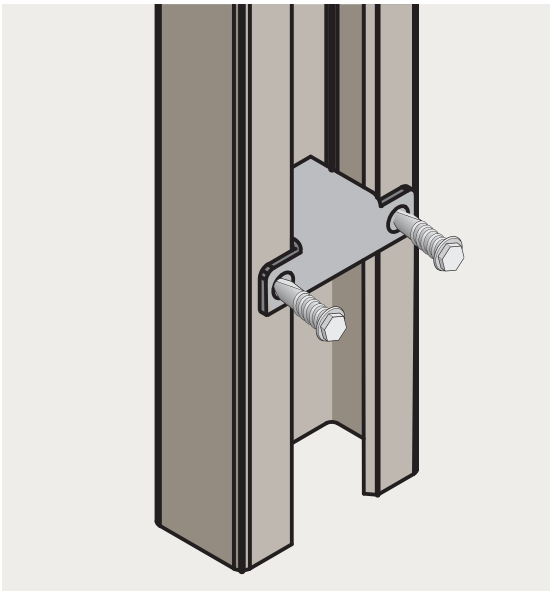

## Step 4

# Post fitment and alignment

Working to a string line on the face of the post, insert the first post into the hole and gradually pour in the concrete (mix as per the manufacturer's recommendations). Continually check the post alignment with a spirit level as the concrete is being poured.

Your string line should have a small amount of clearance between it and your post. If you have your string line always touching the post you can risk pushing it slightly every time and the result will be an 'arc' in the line of the wall.

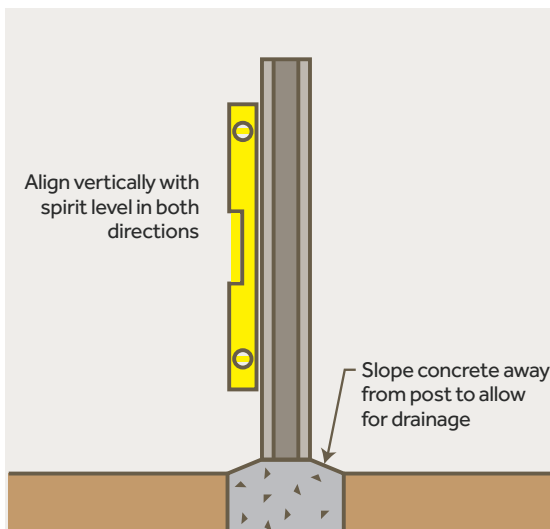
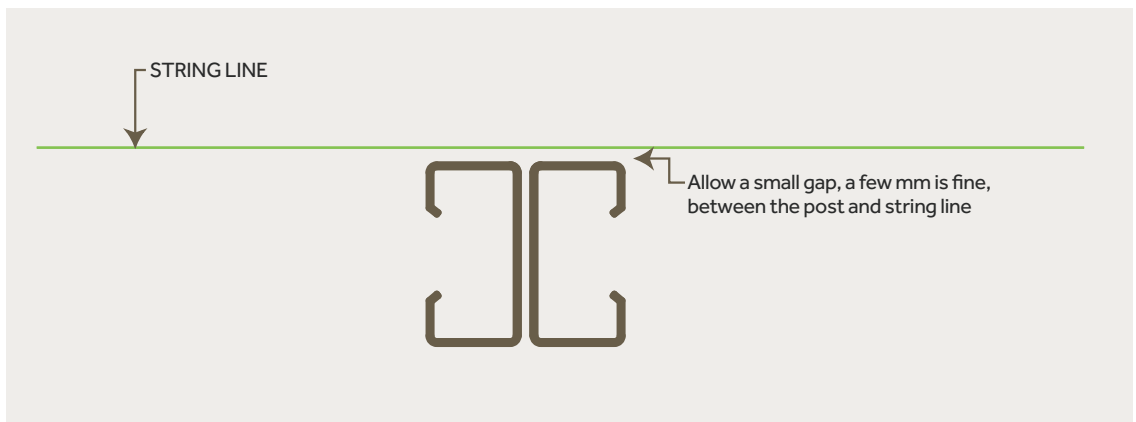



# Step 5

## Spacing consecutive posts

The centre to centre measurement of 2300mm is to allow 10mm per side clearance for the panel. We recommend that you use the bottom channel to act as a spacer between posts

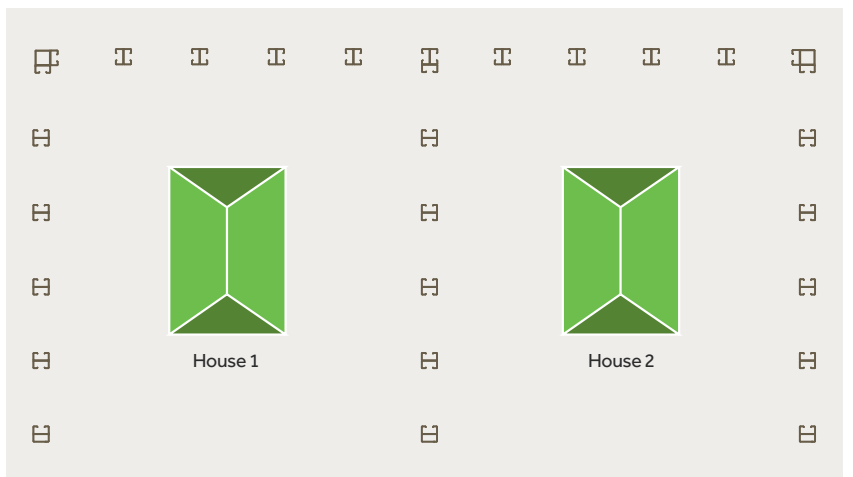
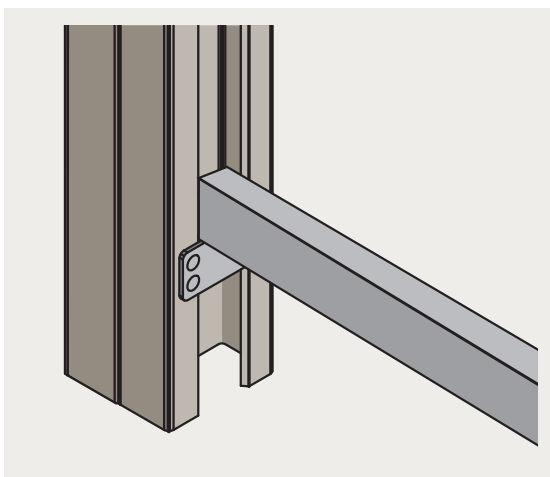
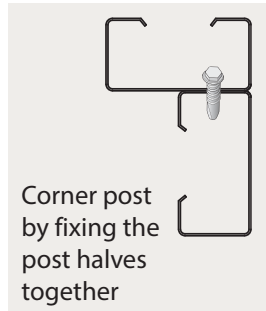
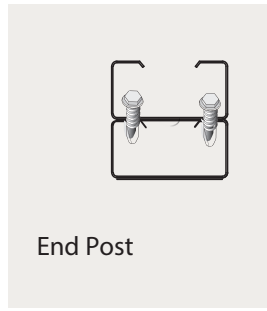
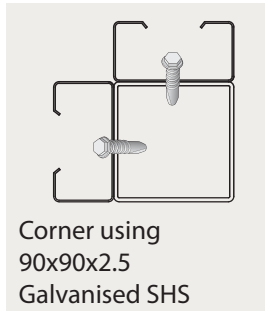
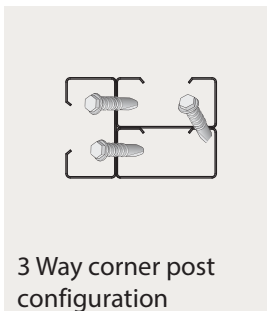
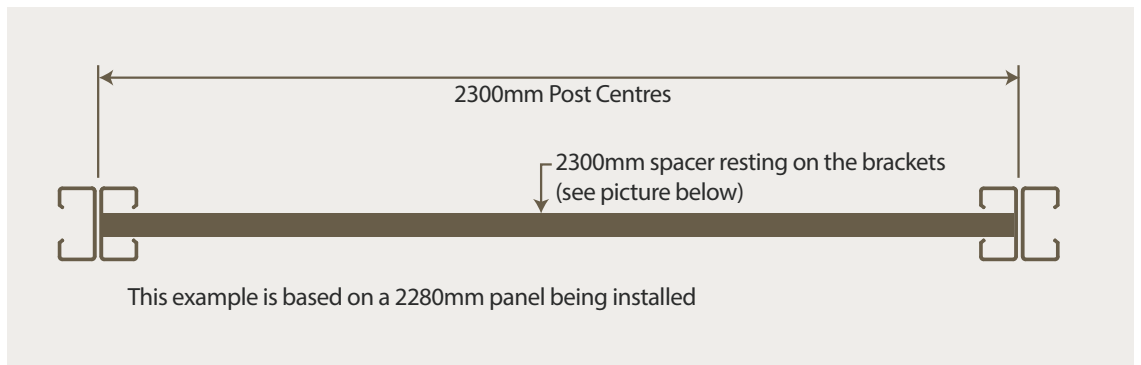

**IMPORTANT:** Allow concrete to cure completely before further assembly. See manufacturers data for concrete curing times.

## Step 6

# Fitting the capping channel to the bottom panel

Once posts are installed and concrete has hardened it is now time to install the fence panels. Firstly you will need to install the bottom rail so it sits neatly down onto the base bracket. When the base bracket is in you will then need

to insert 3 sheets of coloured steel panels into each 2300mm bay. when all sheets are installed as per photos below then you will need to slide the top capping on. **Once you have installed the capping you will need to rivet the sheet joins we recomend using 2 rivets per join.**



Inserted wall panels and top cap.



## Step 7

### Step in the fence line.

If you have a step in the fenceline where you say step from 1800mm to 1200mm as shown below you will need to join one half 1800mm post to the back of a 1200mm post and install as normal.

The post cap will then need to be cut in half and then inserted into the top of each half post.



## Step 8

## Post infill

Post Infil

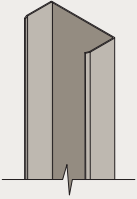

To fill the recess in a post where you are not inserting a panel either for a step in the wall or installing slat channels.

These are designed to be inserted with a small amount of force.

**Note** Where your wall is stepped, this insert can be cut to size to suit the step and inserted in the exposed recess.

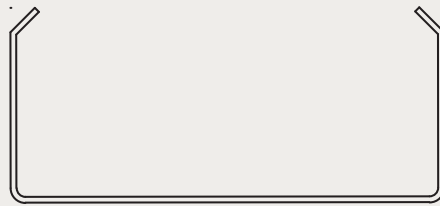

Post Infil



Post Infill inside post

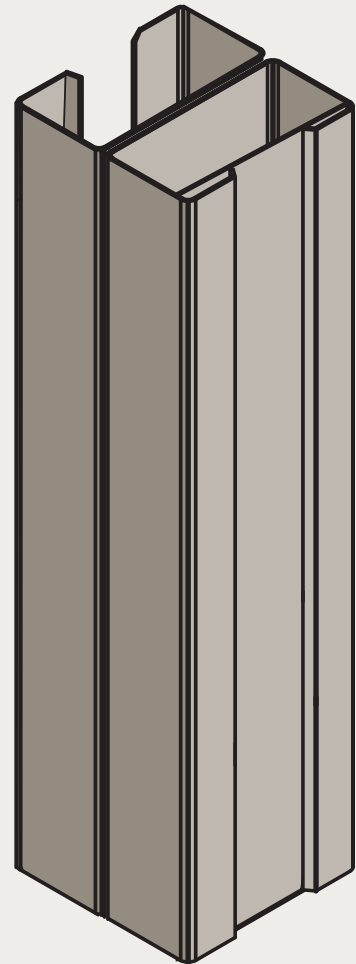



## Step 9

# Fitting the Post Tops

Post Cap

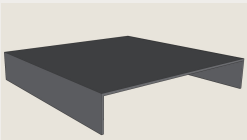

Place one corner over the outside edge of one half post, place the parallel corner over the outside of the same half post section on the other side, this may require some pressure to do so as the cap is designed to be a friction fit. Whilst the cap is on an angle and with the two sides (already firmly in position), the remaining cap can be fitted over the outside of the post. The post cap is friction fitted which in some cases may require some pressure to fit.

\*If a more permanent fix is required, than a coloured rivet can be supplied (1 per cap) to fix this place. Please advise if these are required.

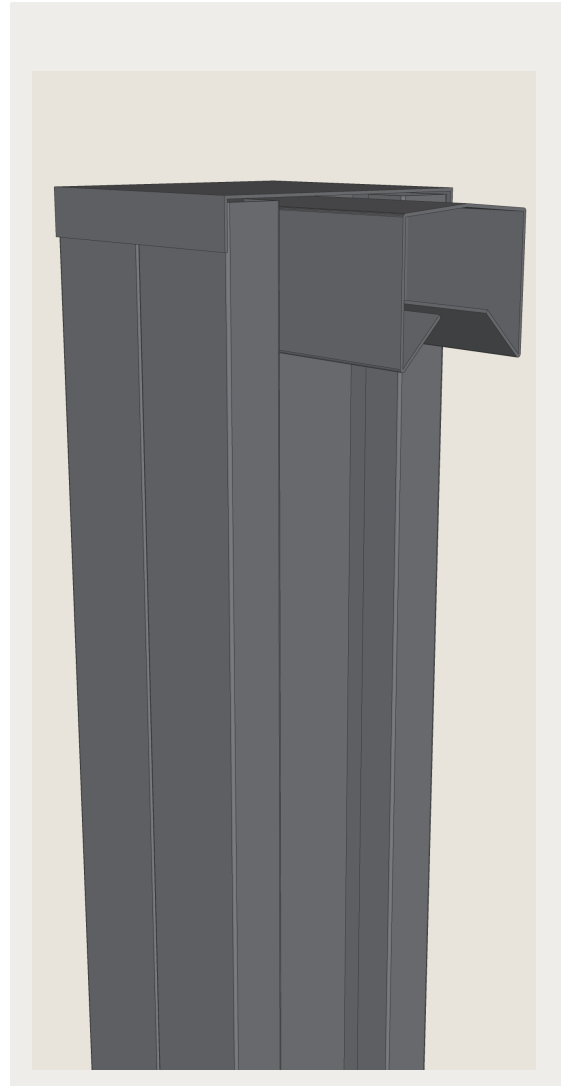
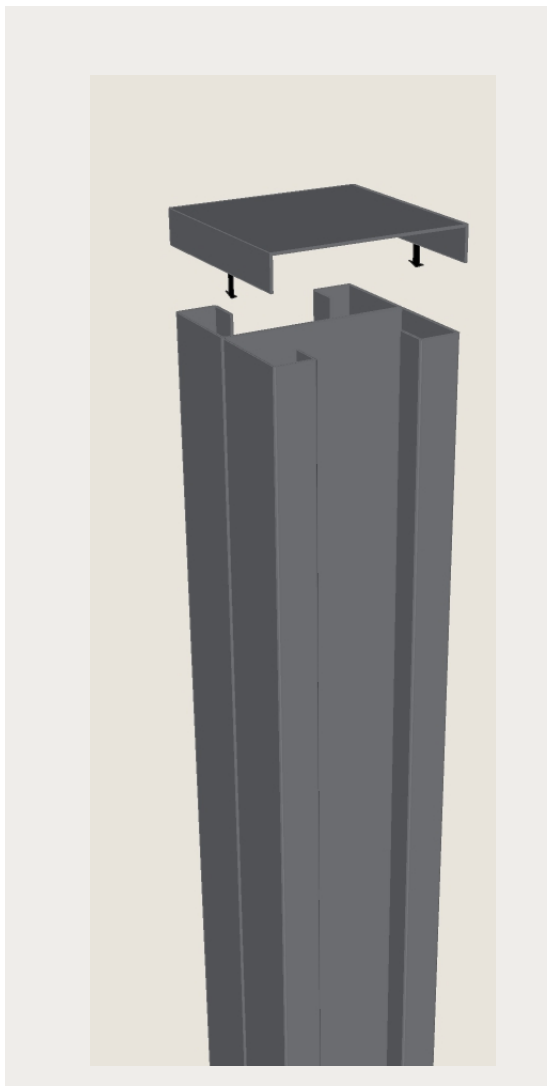

## Step 1

### Slat Installation

Slat panels will only be included if you have ordered the Styleline Wall system.

This guide will show you how to install 65x16mm slats in between your posts

Insert your end post infills i to the post as shown in the diagram below.

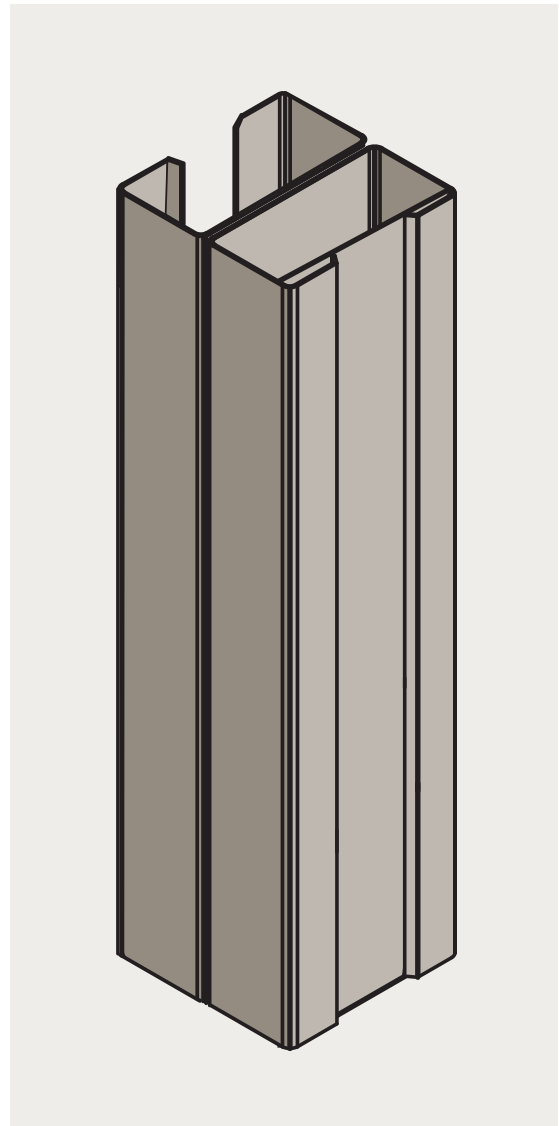
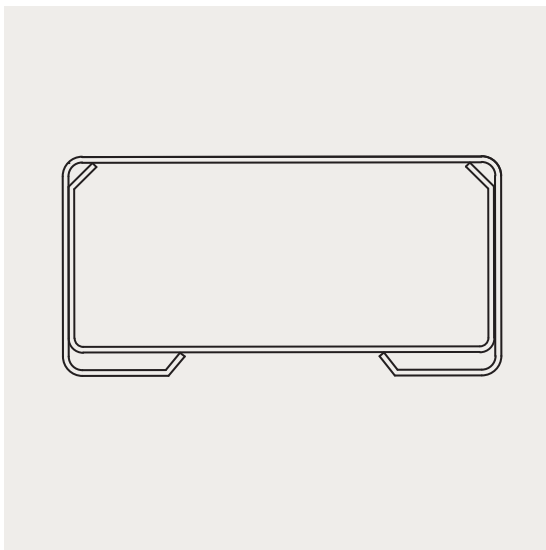
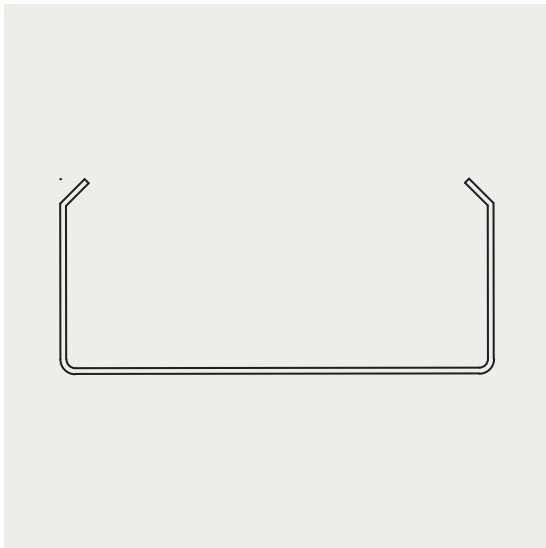

## Step 2

### STEP 2 – Install your mounting channels

Over a 600mm length it is recommended that approx. 4 fixings be used along the length of the channel . These can be screws, rivets or any appropriate anchor for the substrate behind the channel i.e. a masonry anchor if attaching to brickwork.

Install both mounting channels at this stage.

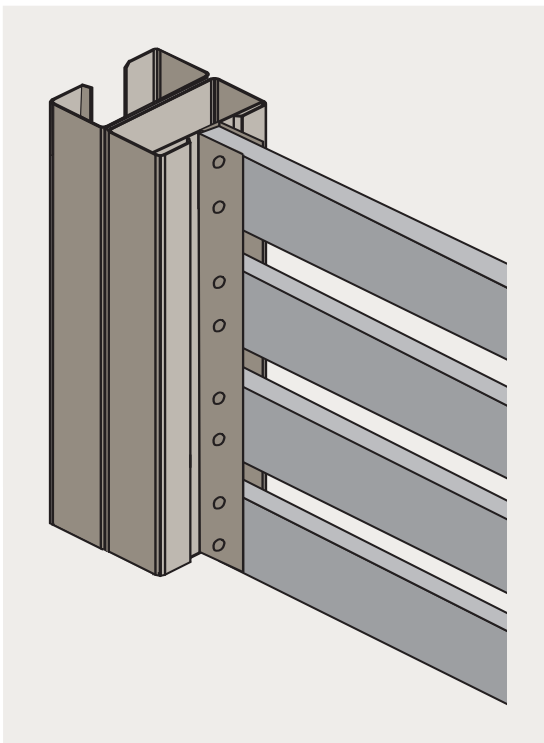
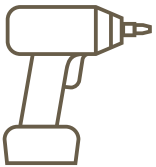

## Step 3

# Slat Installation

### Step 3 – Cutting your slats to the correct length

Measure from inside of one channel to the inside of the next. Remember you need to provide clearance for the slat to travel past the heads of the channel mounting screws. Allow approx 10mm clearance more than the tight measurement between back of the 2 channels. There is NO advantage of being super tight, you will only cause yourself difficulties during installation.

**Cut one slat first and try it before cutting them all**, it should be a nice a free fit and not collide with the screws inside the channels.

### Installing your slats

With your spacer on the bottom install the first slat. Secure the slat to the channel using a single screw or rivet through the channel and into the slat on the rear side of the wall.





## Step 4

# Slat Installation

### STEP 4 – Slat spacing

Be sure that the spacer you use wont mark the finished surface of the slat. Plastic spacers/shims in the correct size as pictured below can be purchased from most hardware stores. Drill and rivet only one side (normally the inside of the fence as you put the slats in.

**NOTE – gaps always 'grow' so if you determine that you need a 10mm gap a spacer/packer closer to 9 - 9.5mm would probably be more suitable. This is just something to be aware and cautious of.**

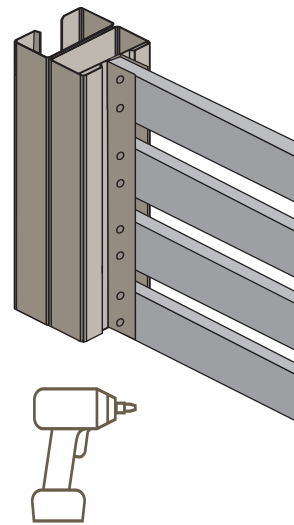

Continue this for all slats until installed. Secure one slat at a time and keep moving your spacer up as you go.



## Additional

## Additional Information

### Stepping or Raking your wall

This will generally be the most complex part of any installation. Please take the time to draw it out on a piece of paper before setting any posts in the ground. Having to remove posts that are concreted in can be very disheartening! And remember we are always here to help you get it right so if you are unsure please ask.

There are three methods for dealing with sloping ground. The examples below are based around an 1800mm high wall.

Method 1 Stepping the bottom of your panels & maintaining a minimum 1800mm wall height.

**Note** This will leave a void/gap under one end of your wall panels.

Method 2 Raking/cutting the base panel & maintaining a maximum 1800mm wall height.

**Note** This will leave no void/gap under your wall panels but will reduce your wall height at one end.

Method 3 Raking/cutting the base & maintaining a minimum 1800mm wall height at one end and a taller wall height at the low end of the slope. (please note if you are trying to achieve this method you would need some longer sheets to suit the extra height. This need to be taken into consideration at time of ordering.)

**Note** This will leave no void/gap under your wall panels but will increase your wall height at the lower end of the slope above 1800mm.

#### Cutting the panels:

**STOP** – Wear the appropriate safety equipment for performing the task. Eye wear, hearing protection & a dust mask.

The panels can be cut using a with an angle grinder with a 1mm cutting blade to cut through the sheeting.

#### Cutting the posts:

**STOP** – Wear the appropriate safety equipment for performing the task such as, eye wear, hearing protection & a dust mask.

Mark the post and use an angle grinder with a 1mm cutting blade to cut through the post.

**Note** All cut edges that will remain exposed to the elements will require treating with a zinc rich paint such as 'cold gal' or similar.

Cut edges should be put down into the footing wherever possible.

### Stepping Method 1

– **Maintaining a minimum 1800mm wall height**

As pictured below it should be noted that you will be left with a void at the low end of the slope but you will maintain a minimum 1800mm wall height. In most cases on gradual slopes this void won't be large and can either be left as is or planted in front of.

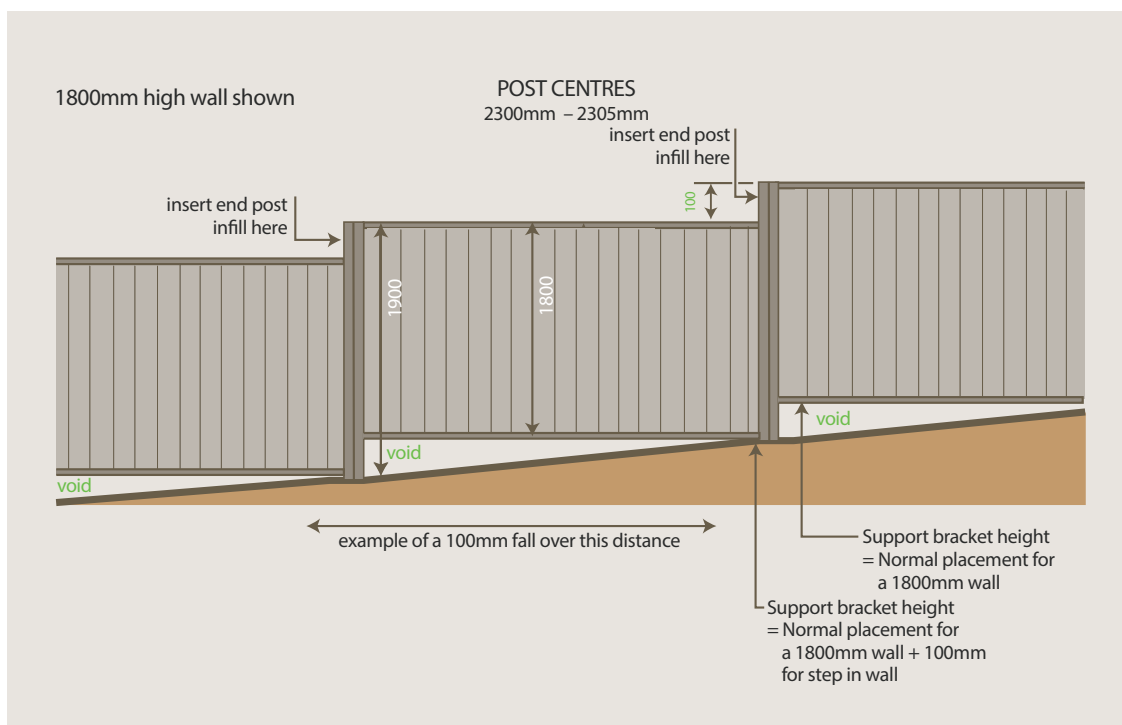

Additional

Stepping Method 2

– Rake/Cut your bottom panel to the slope using 1800mm worth of wall panels

You will maintain a maximum height of 1800mm wall height – As pictured below it should be noted that your wall height at the high side of the slope will be reduced by the amount of the rake – in this situation 100mm.

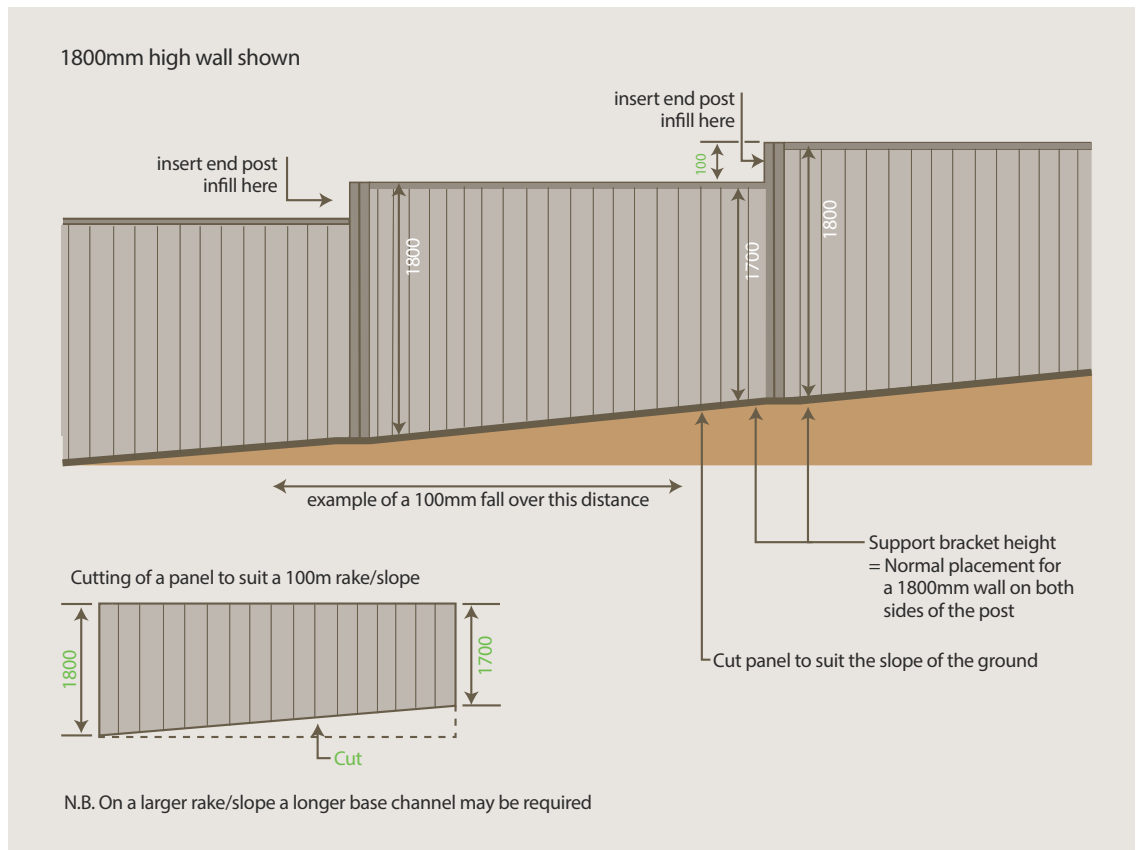

### Stepping Method 3

– **Rake/Cut your bottom panel to the slope using 1900mm worth of fence panel to maintain a minimum 1800mm wall height.**

You will maintain a maximum height of 1800mm wall height – As pictured below it should be noted that your wall height at the high side of the slope will be increased by the amount of the rake – in this situation 100mm.

Depending on the additional height gained by doing this you may require deeper footings and longer posts. Please contact us for specific advice before installation.

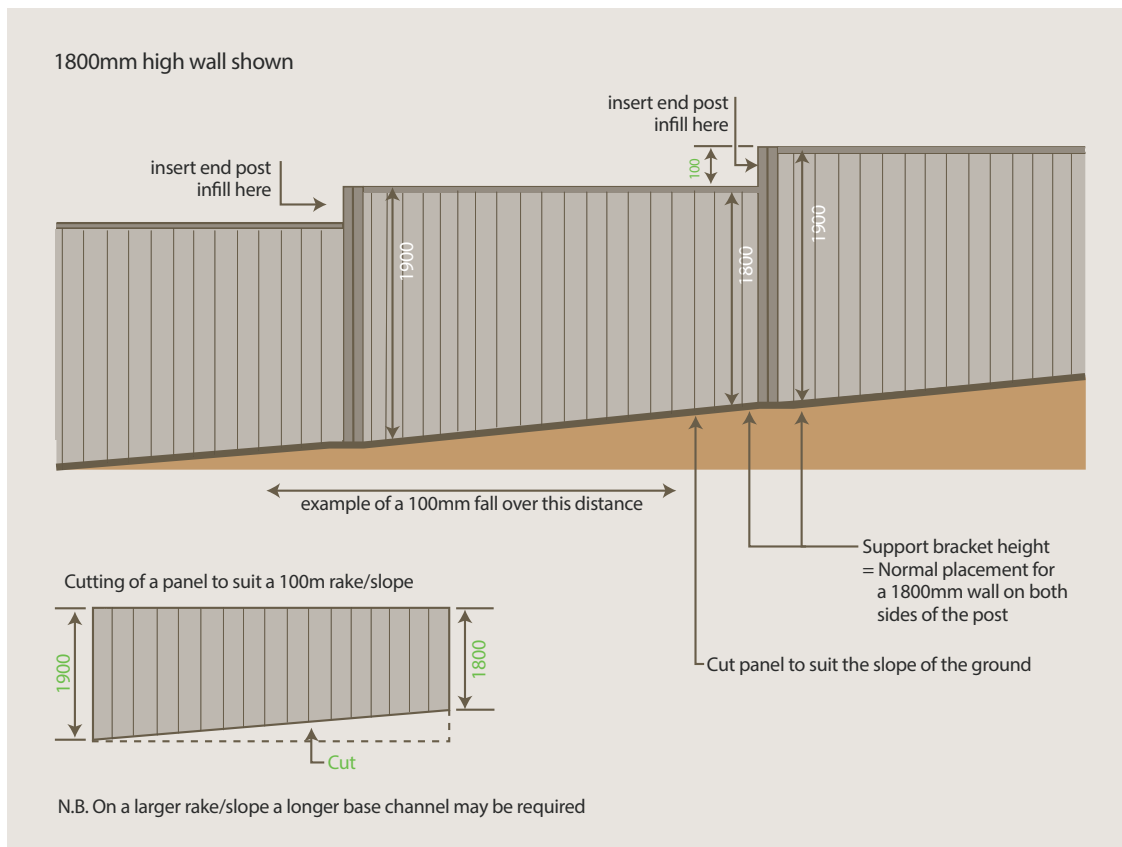



## Finished Fences







*Thank you for  
Choosing*

**S=CTOR**  
**PANEL FENCING**  
SOUND / SIMPLE / FAST

