



# **WET & DRY VACUUM 40L - L CLASS**

- **40L STAINLESS STEEL TANK**
- **1200W MOTOR**
- **L - CLASS CERTIFIED**
- **HEPA FILTER - 99.95% RETENTION**



## **INSTRUCTION MANUAL**



**WARNING:** Read all safety warnings and all instructions. Failure to follow the warnings and instructions may result in electric shock, fire and/or serious injury. Save all warnings and instructions for future reference.

## SPECIFICATIONS - MODEL NO. FBWDV-1240PT

<b>Voltage:</b>	220-240V ~ 50-60Hz
<b>Input power:</b>	1200W
<b>Power outlet max.:</b>	1200W
<b>Psum:</b>	2400W
<b>Suction power max.:</b>	220 mbar
<b>Tank capacity (Dry):</b>	40 l
<b>(Wet):</b>	28 l
<b>Suction hose::</b>	Ø36mm x 3m
<b>Dust class:</b>	L (Can be used for materials where the dust OEL values are >1mg/m3)
<b>IP rating</b>	IPX4
<b>Sound power lever:</b>	88 dB (A)
<b>Gross weight:</b>	14.6 kg

## KNOW YOUR PRODUCT

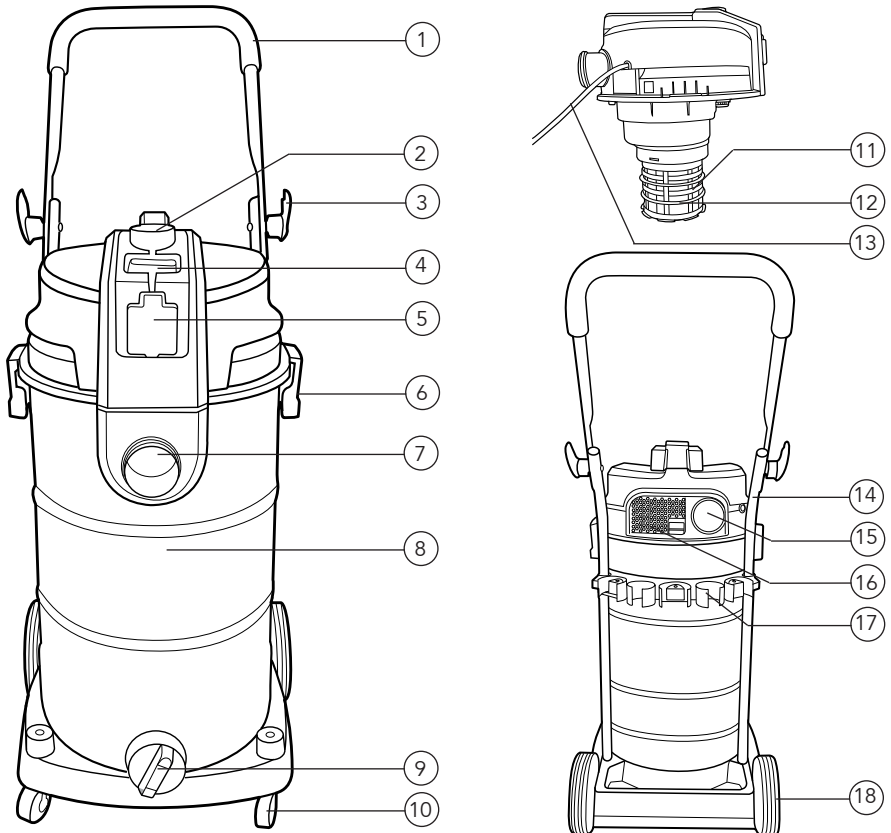

## KNOW YOUR PRODUCT (cont.)

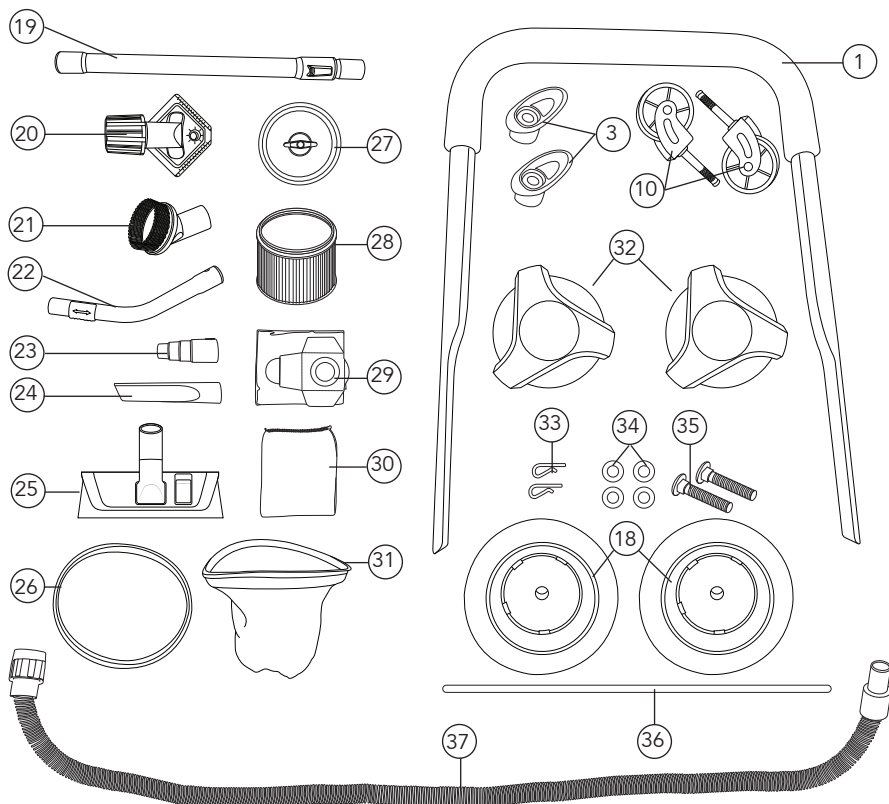

- |                                    |                                 |                                    |
|------------------------------------|---------------------------------|------------------------------------|
| 1. Main handle                     | 15. Blower port                 | 29. Dust bag (Dry)                 |
| 2. Filter clean button             | 16. Filter cover                | 30. Foam filter (Wet)              |
| 3. 2 x Handle fastener             | 17. Accessory bracket           | 31. Coarse filter (Dry)            |
| 4. On/off/automatic switch         | 18. Wheels                      | 32. 2 x Wheel caps                 |
| 5. Automatic power take-off outlet | 19. Telescopic suction tube     | 33. 2 x R-clips for fitting wheels |
| 6. Motor securing clip             | 20. Drilling nozzle             | 34. 4 x Washers for fitting wheels |
| 7. Vacuum inlet                    | 21. Upholstery nozzle           | 35. 2 x Bolts for fitting handle   |
| 8. Tank                            | 22. Air regulator               | 36. Axle for fitting wheels        |
| 9. Water drain outlet              | 23. Electric tool adaptor       | 37. Flexible suction Hose          |
| 10. 2 x Castors                    | 24. Crevice nozzle              |                                    |
| 11. Filter cage                    | 25. Dual purpose floor nozzle   |                                    |
| 12. Safety float valve             | 26. Sealing ring                |                                    |
| 13. Power cable                    | 27. Cap for fitting HEPA filter |                                    |
| 14. Lower handle                   | 28. HEPA filter (Dry)           |                                    |

## TABLE OF CONTENTS

SPECIFICATIONS.....	Page 02
KNOW YOUR PRODUCT.....	Page 02
INTRODUCTION.....	Page 05
SAFETY INSTRUCTIONS.....	Page 05
ASSEMBLY.....	Page 10
SUCTION NOZZLES.....	Page 13
OPERATION.....	Page 14
MAINTENANCE.....	Page 16
DESCRIPTION OF SYMBOLS.....	Page 18
CONTENTS.....	Page 19
WARRANTY.....	Page 20

## INTRODUCTION

Congratulations on purchasing a Full Boar Wet and Dry Vac.

The Full Boar Wet and Dry Vac is designed for wet and dry vacuuming using the appropriate filter. The appliance is not suitable for the vacuuming of combustible, explosive or harmful substances.

## SAFETY INSTRUCTIONS



**WARNING!** When using mains-powered equipment, basic safety precautions, including the following, should always be followed to reduce risk of fire, electric shock, personal injury and material damage.

Read and understand the manual prior to operating this tool.

Save these instructions and other documents supplied with this tool for future reference.

## ELECTRICAL SAFETY

The electric motor has been designed for 220V and 240V only. Always check that the power supply corresponds to the voltage on the rating plate.

**Note:** The supply of 230V and 240V on Full Boar tools are interchangeable for Australia and New Zealand.

**Note:** The power outlet used for the vacuum must be protected by a 30mA residual current device or earth leakage circuit breaker.

The supply cord is assessed as type Y attached by using AS/NZS 60335.1.

If the supply cord is damaged, it must be replaced by an electrician or a power tool repairer in order to avoid a hazard.

### Using an Extension Lead

Always use an approved extension lead suitable for the power input of this tool. Before use, inspect the extension lead for signs of damage, wear and ageing. Replace the extension lead if damaged or defective. When using an extension lead on a reel, always unwind the lead completely. Use of an extension lead not suitable for the power input of the tool or which is damaged or defective may result in a risk of fire and electric shock.

# GENERAL POWER TOOL SAFETY WARNINGS



**WARNING!** Read all safety warnings and instructions. Failure to follow all instructions listed below may result in electric shock, fire and/or serious injury. The term “power tool” in all of the warnings listed below refers to your mains operated (corded) power tool or battery operated (cordless) power tool.

## SAVE THESE INSTRUCTIONS

### 1. Work area safety

- a. **Keep work area clean and well lit.** Cluttered or dark areas invite accidents.
- b. **Do not operate power tools in explosive atmospheres, such as in the presence of flammable liquids, gases or dust.** Power tools create sparks which may ignite the dust or fumes.
- c. **Keep children and bystanders away while operating a power tool.** Distractions can cause you to lose control.

### 2. Electrical safety

- a. **Power tool plugs must match the outlet. Never modify the plug in any way. Do not use any adapter plugs with earthed (grounded) power tools.** Unmodified plugs and matching outlets will reduce risk of electric shock.
- b. **Avoid body contact with earthed or grounded surfaces, such as pipes, radiators, ranges and refrigerators.** There is an increased risk of electric shock if your body is earthed or grounded.
- c. **Do not expose power tools to rain or wet conditions.** Water entering a power tool will increase the risk of electric shock.
- d. **Do not abuse the cord. Never use the cord for carrying, pulling or unplugging the power tool. Keep cord away from heat, oil, sharp edges or moving parts.** Damaged or entangled cords increase the risk of electric shock.
- e. **When operating a power tool outdoors, use an extension cord suitable for outdoor use.** Use of a cord suitable for outdoor use reduces the risk of electric shock.
- f. **If operating a power tool in a damp location is unavoidable, use a residual current device (RCD) protected supply.** Use of an RCD reduces the risk of electric shock.

### 3. Personal safety

- a. **Stay alert, watch what you are doing and use common sense when operating a power tool. Do not use a power tool while you are tired or under the influence of drugs, alcohol or medication.** A moment of inattention while operating power tools may result in serious personal injury.
- b. **Use personal protective equipment. Always wear eye protection.** Protective equipment such as dust mask, non-skid safety shoes, hard hat, or hearing protection used for appropriate conditions will reduce personal injuries.
- c. **Prevent unintentional starting. Ensure the switch is in the off-position before connecting to power source and/or battery pack, picking up or carrying the tool.** Carrying power tools with your finger on the switch or energising power tools that have the switch on invites accidents.

## GENERAL POWER TOOL SAFETY WARNINGS (cont.)

- d. **Remove any adjusting key or wrench before turning the power tool on.** A wrench or a key left attached to a rotating part of the power tool may result in personal injury.
  - e. **Do not overreach. Keep proper footing and balance at all times.** This enables better control of the power tool in unexpected situations.
  - f. **Dress properly. Do not wear loose clothing or jewellery. Keep your hair, clothing and gloves away from moving parts.** Loose clothes, jewellery or long hair can be caught in moving parts.
  - g. **If devices are provided for the connection of dust extraction and collection facilities, ensure these are connected and properly used.** Use of dust collection can reduce dust-related hazards.
  - h. **Do not let familiarity gained from frequent use of tools allow you to become complacent and ignore tool safety principles.** A careless action can cause severe injury within a fraction of a second.
- 4. Power tool use and care**
- a. **Do not force the power tool. Use the correct power tool for your application.** The correct power tool will do the job better and safer at the rate for which it was designed.
  - b. **Do not use the power tool if the switch does not turn it on and off.** Any power tool that cannot be controlled with the switch is dangerous and must be repaired.
  - c. **Disconnect the plug from the power source and/or the battery pack from the power tool before making any adjustments, changing accessories, or storing power tools.** Such preventive safety measures reduce the risk of starting the power tool accidentally.
  - d. **Store idle power tools out of the reach of children and do not allow persons unfamiliar with the power tool or these instructions to operate the power tool.** Power tools are dangerous in the hands of untrained users.
  - e. **Maintain power tools. Check for misalignment or binding of moving parts, breakage of parts and any other condition that may affect the power tool's operation. If damaged, have the power tool repaired before use.** Many accidents are caused by poorly maintained power tools.
  - f. **Keep cutting tools sharp and clean.** Properly maintained cutting tools with sharp cutting edges are less likely to bind and are easier to control.
  - g. **Use the power tool, accessories and tool bits etc. in accordance with these instructions, taking into account the working conditions and the work to be performed.** Use of the power tool for operations different from those intended could result in a hazardous situation.
  - h. **Keep handles and grasping surfaces dry, clean and free from oil and grease.** Slippery handles and grasping surfaces do not allow for safe handling and control of the tool in unexpected situations.
- 5. Service**
- a. **Have your power tool serviced by a qualified repair person using only identical replacement parts.** This will ensure that the safety of the power tool is maintained.
  - b. **If the supply cord is damaged,** it must be replaced by an electrician or a power tool repairer in order to avoid a hazard.

## WET & DRY VACUUM SAFETY WARNINGS



**IMPORTANT!** When using the equipment, a few safety precautions must be observed to avoid injuries and damage. Please read the complete operating manual with due care. Keep this manual in a safe place so that the information is available at all times. If you give the equipment to any other person, give them these operating instructions as well.

The manufacturer cannot accept any liability for damage or accidents which arise due to a failure to follow these instructions and the safety information.



**WARNING!** DO NOT connect power tools to outlet when using the vacuum for wet pick up.

- **Do not leave appliance unattended when plugged in.** Unplug from outlet when not in use and before servicing and cleaning.
- **To avoid electric shock, do not expose to rain.** Store indoors.
- **Never use in the presence of explosive liquids, vapours or explosive dust**  
- such as coal or grain.
- **Never pick up asbestos or asbestos dust.**
- **Wood dust and chips in a confined area can give rise to fire or an explosion.** Guard against possible ignition sources.
- **Do not pick up anything that is burning or smouldering** – such as metal grinding dust, cigarette ends, hot coals, matches or similar.
- **The appliance is not intended for use by young children or infirm persons without supervision.** Young children should be supervised to ensure they do not play with the appliance.
- **Use only manufacturer's recommended attachments and consumables.**
- **Never modify the cleaner in any way** - this is dangerous and will invalidate the warranty.
- **Do not use cleaner without the filter in place.**
- **If motor sound becomes higher pitched always check for the following:**  
- Blocked hose or accessory. - Blocked filter - Full container.
- **Never try to move the cleaner by pulling with the mains lead.**
- **Always check that the filter is clear and not blocked.** Keep all openings clear of any blockages.
- **When lifting the unit, always lift it with the handle or under rim of bucket.**  
Beware of excess weight.
- **Always switch the unit off before changing attachments or connecting different power tools.**
- **Always disconnect equipment from the appliance when it is not in use.**
- **If the cordset is damaged have it repaired by an authorised service centre.**



## WET & DRY VACUUM SAFETY WARNINGS (cont.)

- **This appliance is not intended for use by persons (including children) with reduced physical, sensory or mental capabilities, or lack of experience and knowledge,** unless they have been given supervision or instruction concerning use of the appliance by a person responsible for their safety.
- **Children should be supervised to ensure that they do not play with the appliance.**
- **The wet and dry vacuum cleaner is designed for wet and dry vacuuming using the appropriate filter.** The appliance is not suitable for the vacuuming of combustible, explosive or harmful substances.
- **The equipment is to be used only for its prescribed purpose.** Any other use is deemed to be a case of misuse. The user / operator and not the manufacturer will be liable for any damage or injuries of any kind caused as a result of this.

# ASSEMBLY



**WARNING!** During assembly ensure the wet and dry vac is switched OFF and disconnected from the power supply.

## Fitting the wheels (13)

1. Place a R-clip (33) for fitting the wheels through the appropriate hole in the axle (36) (Fig. 1).
2. Fit a washer (34) a wheel (18) and another washer (34) to the axle (36) (Fig. 2).
3. Now slide the axle (36) through the guides provided for it on the underside of the Tank (8) (Fig. 3).

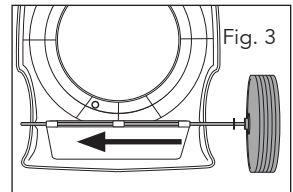
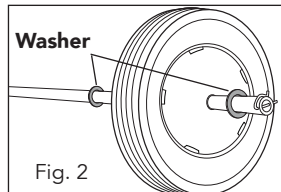
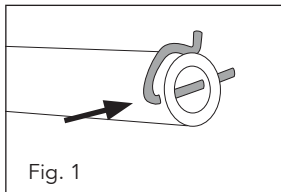

4. Fit the third washer (34) to the empty end of the axle (36) then the second wheel (18). Secure it with the remaining washer (34) and the R-clip (33).
5. Push the covers (32) on to the outside of the wheels (18) so that the hooks on the covers (32) clip into the five slots in the wheel (18). (Fig. 4).

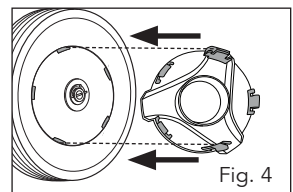

## Fitting the castors (10)

1. Fit the castors (10) into the appropriate mountings on the underside of the tank (8). Push the castors (10) firmly into the mounting until they engage with a clicking noise (Fig. 5).

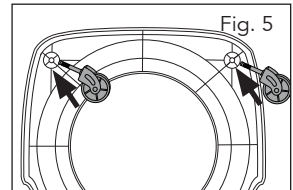

## Fitting the main handle (1)

1. Place the main handle (1) over the ends of the lower handle (14). Align the holes and secure in place using handle bolt (35) and handle fastener (3) (Fig. 6).
- Note.** There are 2 holes on each end of the lower handle (14), select the appropriate hole for the height of the user.

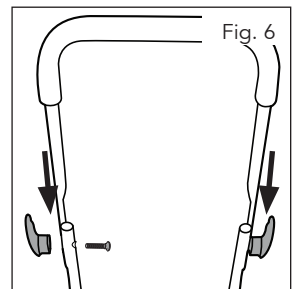

## ASSEMBLY (cont.)

### Fitting the motor head

1. The motor head is fastened to the tank (8) by the motor securing clips (6) (Fig. 7).
2. To remove the motor head, open the motor securing clips (6) and lift the motor head (Fig. 8).
3. When fitting the motor head, make sure that the motor securing clips (6) lock into place correctly (Fig 9).

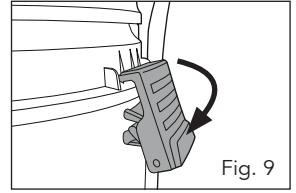
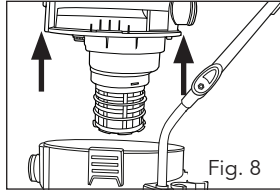
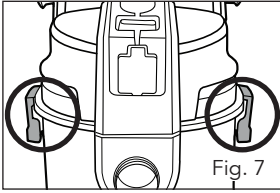

### Fitting the filter



**IMPORTANT!** Never use the wet and dry vacuum cleaner without a filter. Check that the filter is securely fitted at all times.

### Fitting the foam filter (30) - vacuuming liquid:

1. For wet vacuuming, slip the supplied foam filter (30) over the filter cage (11) (Fig.10).

**Note:** The **HEPA filter (28)**, is not suitable for wet vacuuming.

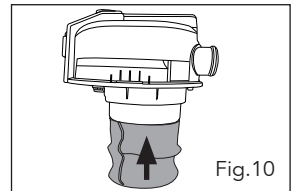

### Fitting the HEPA filter (28) - vacuuming dry matter:

HEPA (high-efficiency particulate air) filtration captures 99.95% (0.3 microns or larger) of dust, pollen, bacteria and other allergens.

1. For dry vacuum cleaning always use the HEPA filter (28). If it is not fitted, slip it over the filter cage (11), flat side of filter first (Fig. 11).

**Note:** Do not use the **foam filter (30)** when vacuuming dry matter.

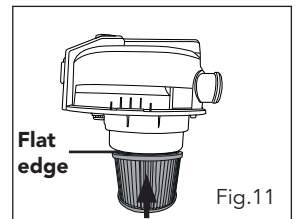

2. Place the cap (27) on the base of the HEPA filter (28) aligning with the keyway as you do so, turn clockwise to lock in position (Fig. 12).

**Note:** The rubber extruded ring is at the bottom of the filter and should fit in the groove of the cap (27).

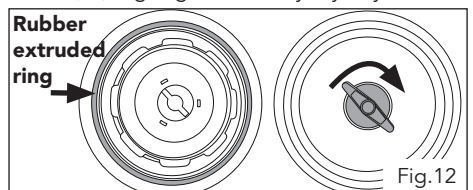

## ASSEMBLY (cont.)

### Fitting the coarse filter (31) - vacuuming dry matter:

The coarse filter (31) can be used for when vacuuming large amounts of fine dust (with or without a dust bag (29)).

**Note:** The **coarse filter (31)**, is not suitable for wet vacuuming.

1. Place the coarse filter (31) on the rim of the tank (8) (Fig. 13). Ensure that the coarse filter (31) is fitted completely on the rim of the tank (8).

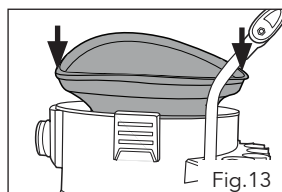

### Fitting the sealing ring (26)

The sealing ring (26) must be fitted for wet vacuuming and whenever the coarse filter (31) is not used.

1. Place the sealing ring (26) on the rim of the tank (8) (Fig. 14). Ensure that the sealing ring (26) is fitted completely on the rim of the tank (8).

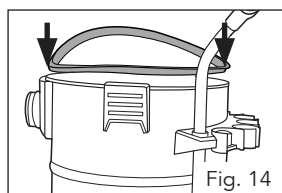

### Fitting the dust bag (29) - vacuuming dry matter

For vacuuming fine, dry dirt it is recommended that you fit a dust bag (29). This will ensure that the HEPA filter (28) does not clog up so quickly and help maintain the vacuuming power. A dust bag (29) is suitable for dry vacuuming only. Using the dust bag (29) makes it easier to dispose of the dust that has been collected.

1. To attach, slip the dust bag (29) over the vacuum inlet. (Fig. 15).

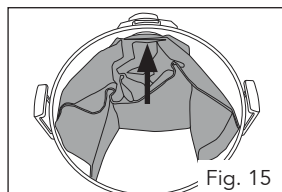

### Fitting the flexible suction hose (37)

Connect the suction hose (37) to the corresponding connector on the wet and dry vacuum cleaner, depending on the application required.

### Vacuuming

Connect the suction hose (37) to the vacuum inlet (7) (Fig. 16).

### Blowing

Connect the suction hose (37) to the blow port (15) (Fig. 17).

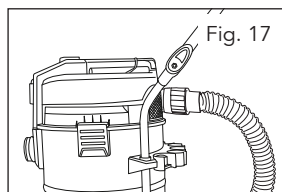
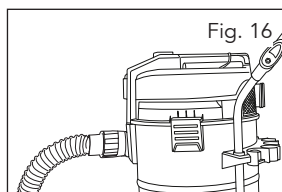

# SUCTION NOZZLES

## Telescopic suction tube (19)

The flexible suction hose (37) can be extended by attaching the telescopic suction tube (19) (Fig. 18).

The height of the telescopic suction tube (19) can be adjusted by using the quick height adjustment. (Fig. 19)

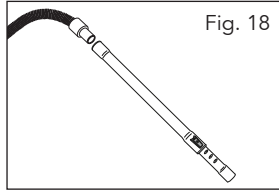

Fig. 18

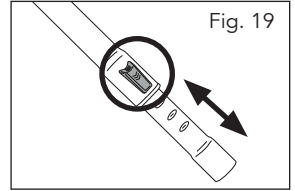

Fig. 19

Extension length: 543-904mm

## Air regulator (22)

The air regulator (22) can be fitted between the flexible suction hose (37) and the telescopic suction tube (19) (Fig. 20). The suction power of the nozzle can be adjusted by using the band on the air regulator (22) (Fig. 21).

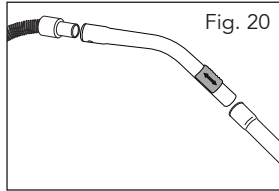

Fig. 20

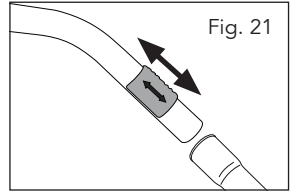

Fig. 21

When wet vacuuming, make selective use of the air regulator to suck in air as well as liquids. This will help to take some strain off the equipment when vacuuming liquids.

## Dual purpose floor nozzle (25)

The dual-purpose floor nozzle (25) is for vacuuming solids and liquids over medium to large areas (Fig. 22).

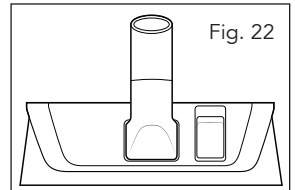

Fig. 22

## Crevice nozzle (24)

The crevice nozzle (24) is designed for vacuuming solids and liquids in corners, edges and other areas that are difficult to access (Fig. 23).

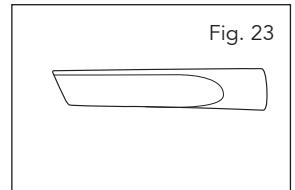

Fig. 23

## Upholstery nozzle (21)

The upholstery nozzle (21) is specially designed for vacuuming solids on upholstery and carpets. (Fig. 24).

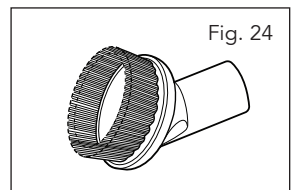

Fig. 24

# OPERATION



**WARNING!** The power supply for this product should be protected by a residual current device rated at 30mA or less.

## ON/OFF/AUTOMATIC switch (4) (Fig. 25)

Switch position 0: Off

Switch position I: Normal operation

Switch position AUTO: Automatic mode - for use in power take-off function. Max. 1200W (see **Automatic mode**).

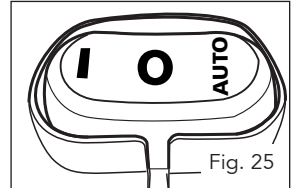

## Dry vacuuming

Use the HEPA filter (28) for dry vacuuming (Fig. 26) (see **Fitting the HEPA filter**).

The dust bag (29) can also be fitted for removal of particularly heavy dirt (Fig. 27) (see **Fitting the dust bag**).

If you want to suction large amounts of fine dust, you can use the coarse filter (31) (Fig. 28) (see **Fitting the coarse filter**)

Always ensure that the filters are perfectly secure.

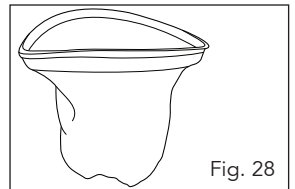
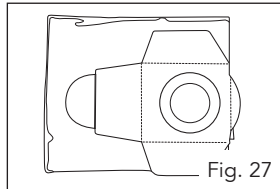
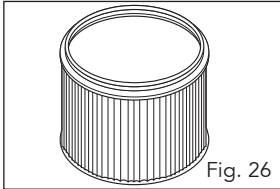

## Wet vacuuming

For wet-vacuuming, use the foam filter (30) (Fig. 29) (see **Fitting the foam filter**).

Check that the filter is securely fitted at all times.

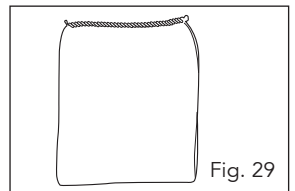

The sealing ring (26) must be fitted for wet vacuuming (Fig. 30) (see **Fitting the sealing ring**)

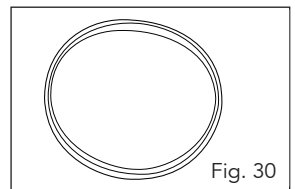

## OPERATION (cont.)

### Water drain outlet (9)

To make the Tank (8) easier to empty after wet vacuuming, it is fitted with a water drain outlet (9).

Open the water drain outlet (9) by turning it anti-clockwise (Fig. 31) and drain the liquid.

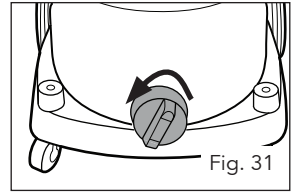

**IMPORTANT!** When wet vacuuming, the safety float valve (12) closes when the maximum tank level (28 litres) is reached. At the same time, the suction noise of the equipment will change and become louder. You must then switch off the equipment and empty the tank.



**IMPORTANT!** The wet and dry vacuum cleaner is not suitable for the vacuuming of combustible liquids. For wet vacuuming, use only the supplied foam filter (30).

### Automatic mode (1200W max.)

Connect the power cable on your electric tool to the automatic power take-off outlet (5) and connect the suction hose (37) to the extractor connector on your electric tool. Check that the connections are secure and airtight.

You can use the supplied electric tool adaptor (23) to connect the flexible suction hose (37) to the electric tool. To do so, fit it between the suction hose (37) and the extractor port on the electric tool (Fig. 32).

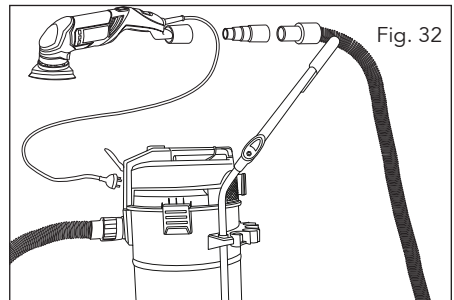

Set the switch (4) on the wet and dry vacuum cleaner to position AUTO, automatic mode (Fig. 33). The moment you switch on the electric tool, the wet and dry vacuum cleaner switches on as well. When you switch off the electric tool, the wet and dry vacuum cleaner switches off as well after a preset delay.

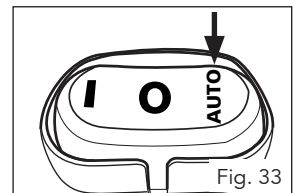

### Blowing

Connect the suction hose (37) to the blower port (15) on the wet and dry vacuum cleaner (Fig. 34).

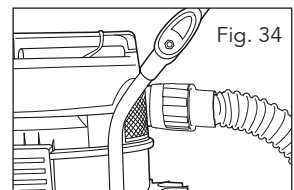

## OPERATION (cont.)

### Drilling nozzle (20)

Due to the smooth flat surface of the drilling nozzle the suction of the vacuum cleaner will fix the drilling nozzle to the drilling surface, you can drill holes with both hands on the drill and have a cleaner work environment. (Fig. 35).

**Note:** Accepts drill bits up to 12mm diameter.

To connect the flexible suction hose (37) to the drilling nozzle (20), loosen the drilling nozzle collar, insert hose and retighten.

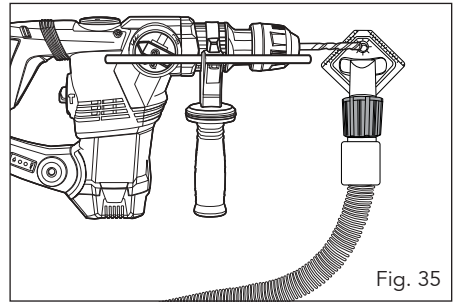

### Filter cleaning system (Fig. 36)

The equipment has a filter cleaning system which enables large amounts of fine dust to be vacuumed without fitting the dust bag (30). If there is a drop in suction performance this feature will clean the dirty coarse filter (31) and increase the suction performance again.

**Note:** The filter cleaning system can only be activated if the coarse filter (31) is fitted and the vacuum is in operation.

Actuate the filter clean button (2) three times while the equipment is in operation with the end of the suction hose. Keep the filter clean button (2) pressed down for 4 seconds each time you actuate it. Ensure that the suction hose does not become kinked when you do so.

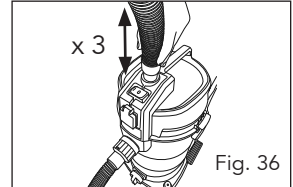

## MAINTENANCE



**WARNING!** Before cleaning your wet & dry vac or carrying out any maintenance procedure, make sure that the motor is off and the vac disconnected from the power supply to prevent accidental starting.

### Cleaning

Keep all safety devices, air vents and the motor housing free of dirt and dust as far as possible. We recommend that you clean the appliance immediately after you use it.

### Cleaning the Tank (8)

The container can be cleaned with a damp cloth and some soft soap or under running water, depending on the amount of dirt.



## MAINTENANCE (cont.)

### Cleaning the filters

#### Cleaning the HEPA filter (28)

The HEPA filter should be checked at regular intervals and cleaned if necessary. If used on a daily basis, change once a year or if damaged.

1. Wear an appropriate air filter face mask.
2. Remove HEPA filter from vacuum.
3. Rinse under a steady stream of water. Turn and rotate the filter under the water to remove any loose surface layer of dust and grime.
4. Use a fine brush or hand brush, while holding it under a steady stream of water to help remove any stubborn dust or grime. If heavily soiled it should be replaced.
5. Wipe away any excess moisture and allow it to air-dry.

#### Cleaning the foam filter (30)

Clean the foam filter with a little soft soap under running water and allow it to air-dry.

#### Cleaning the coarse filter (31)

Clean the coarse filter with a little soft soap under running water and allow it to air-dry.

#### Cleaning the filter

The filter should be checked at regular intervals and cleaned if necessary.

1. Remove the filter cover (16) (Fig. 37).
2. Remove the filter (Fig. 38).
3. Clean the filter by tapping it or blowing it out.
4. Assemble in reverse order

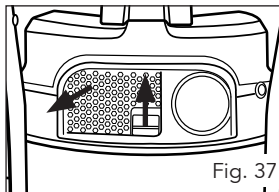

Fig. 37

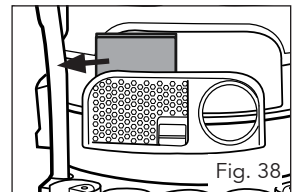





Fig. 38

### Maintenance

At regular intervals and before each use, check that the filters in the wet and dry vacuum cleaner are securely fitted.

## DESCRIPTION OF SYMBOLS

<b>V</b>	Volts	<b>Hz</b>	Hertz
~	Alternating current	<b>W</b>	Watts
<b>/min</b>	Revolutions or reciprocation per minute	<b>n<sub>0</sub></b>	No load speed
l	Litres		Regulator compliance mark
	Read instruction manual		Warning
<b>IPX4</b>	Ingress protection from water	<b>mbar</b>	Pressure rating (millibar)

Dust class	Max. transmittance	Hazards / suitable for
	1 %	<p><b>Keeps back 99% of:</b></p> <ul style="list-style-type: none"> <li>• Dust with OEL values &gt; 1 mg/m<sup>3</sup></li> <li>• Slightly hazardous dusts</li> </ul>

## CARING FOR THE ENVIRONMENT



Power tools that are no longer usable should not be disposed of with household waste but in an environmentally friendly way. Please recycle where facilities exist. Check with your local council authority for recycling advice.



Recycling packaging reduces the need for landfill and raw materials. Reuse of recycled material decreases pollution in the environment. Please recycle packaging where facilities exist. Check with your local council authority for recycling advice.

# CONTENTS

- 1 x Wet & Dry Vac
- 1 x Main handle
- 1 x Air regulator
- 2 x Wheels
- 2 x Castors
- 2 x Wheel covers
- 2 x Securing split pins for wheels
- 4 x Washers for fitting the wheels
- 2 x Bolts for fitting main handle
- 1 x Axle
- 1 x Suction tube, telescopic
- 1 x Electric tool adaptor
- 1 x Crevice nozzle
- 1 x Drilling nozzle
- 1 x Upholstery nozzle
- 1 x Dual purpose floor nozzle
- 1 x HEPA filter & cover
- 1 x Sealing ring
- 1 x Coarse filter
- 1 x Dust bag
- 1 x Foam filter
- 1 x Suction hose
- 1 x Instruction manual

Distributed by:  
Ozito Industries Pty Ltd

**AUSTRALIA (Head Office)**

1-23 Letcon Drive, Bangholme Victoria, Australia, 3175

Telephone: 1800 069 486

# WARRANTY

**YOUR WARRANTY FORM SHOULD BE RETAINED BY YOU AT ALL TIMES. IN ORDER TO MAKE A CLAIM UNDER THIS WARRANTY YOU MUST RETURN THE PRODUCT TO YOUR NEAREST BUNNINGS WAREHOUSE (see [www.bunnings.com.au](http://www.bunnings.com.au) or [www.bunnings.co.nz](http://www.bunnings.co.nz) for store locations) WITH YOUR BUNNINGS REGISTER RECEIPT. PRIOR TO RETURNING YOUR PRODUCT FOR WARRANTY PLEASE TELEPHONE OUR CUSTOMER SERVICE HELPLINE:**

**Australia 1800 069 486  
New Zealand 0508 069 486**

TO ENSURE A SPEEDY RESPONSE PLEASE HAVE THE MODEL NUMBER AND DATE OF PURCHASE AVAILABLE. A CUSTOMER SERVICE REPRESENTATIVE WILL TAKE YOUR CALL AND ANSWER ANY QUESTIONS YOU MAY HAVE RELATING TO THE WARRANTY POLICY OR PROCEDURE.

## **1 YEAR WARRANTY**

Your product is guaranteed for a period of **12 months from the original date of purchase**. If a product is defective it will be repaired in accordance with the terms of this warranty. Warranty excludes consumable parts, for example: wheels, bearings.

The benefits provided under this warranty are in addition to other rights and remedies which are available to you under law. The warranty covers manufacturer defects in materials, workmanship and finish under normal use.

Our goods come with guarantees that cannot be excluded under Australian Consumer law & Consumer Guarantees Act 1993 (NZ). You are entitled to a replacement or refund for a major failure and to compensation for other reasonably foreseeable loss or damage. You are also entitled to have the goods repaired and replaced if the goods fail to be of acceptable quality and the failure does not amount to a major failure.

## **WARRANTY EXCLUSIONS**

**The following actions will result in the warranty being void.**

- If the tool has been operated on a supply voltage other than that specified on the tool.
- If the tool shows signs of damage or defects caused by or resulting from abuse, accidents or alterations.
- Failure to perform maintenance as set out within the instruction manual.
- If the tool is disassembled or tampered with in any way.
- The warranty excludes damage resulting from product misuse or product neglect.

**This warranty is given by Ozito Industries Pty Ltd.**

**ABN: 17 050 731 756**

**Ph.1800 069 486**

Australia/New Zealand (Head Office)

1-23 Letcon Drive, Bangholme, Victoria, Australia 3175