

Model/s  
EO605MB

Version  
V1.3 1022

Everything you need  
for your 60cm 5 Function  
Built-in Oven is in this  
User Manual

**esatto**

# Welcome

**Residentia Group**

—

**Head Office**

165 Barkly Avenue  
Burnley, Victoria  
Australia 3121



—

**ACN**

600 546 656

—

**Online**

residentia.group  
www.esatto.house  
  @esatto.house

—

**Postage**

PO Box 5177  
Burnley, Victoria  
Australia 3121

—

**Telephone**

1300 11 4357

Congratulations on purchasing your new Built-in Oven. The Esatto brand is proudly distributed within Australia by Residentia Group Pty Ltd.

Please refer to the warranty card at the rear of this manual for information regarding your product's parts and labour warranty, or visit us online at: [www.residentia.group](http://www.residentia.group)

At Residentia Group, we are customer obsessed and our Support Team are there to ensure you get the most out of your appliance. Should you want to learn more about your new oven, it's features or importantly taking care of the appliance, our Support Team are here to help.

You can use our online Support Centre at anytime by visiting:  
<http://support.residentiagroup.com.au>

Or you can contact us via phone by dialing: 1300 11 HELP (4357).

It is important that you read through the following use and care manual thoroughly to familiarise yourself with the installation and operation requirements of your appliance to ensure optimum performance.

Again, thank you for choosing an Esatto appliance and we look forward to being of service to you.

Kind Regards,  
The Residentia Team

# Contents

---

**Page 2**  
**Welcome**

---

**Page 4**  
**Safety Instructions**

---

**Page 7**  
**Installation**  
**Instructions**

---

**Page 8**  
**Your Built-in Oven**

---

**Page 9**  
**Operation**  
**Instructions**

---

**Page 11**  
**Maintenance**  
**& Cleaning**

---

**Page 12**  
**Troubleshooting**

---

**Page 13**  
**Technical**  
**Specifications**

---

**Page 15**  
**Purchase Details**

---

**Page 16**  
**Warranty**

# Safety Instructions

## IMPORTANT SAFETY INSTRUCTIONS

READ CAREFULLY AND KEEP FOR FUTURE REFERENCE

Read this manual thoroughly before first use, even if you are familiar with this type of product. The safety precautions enclosed herein reduce the risk of fire, electric shock and injury when correctly adhered to. Make sure you understand all instructions and warnings.

Keep the manual in a safe place for future reference, along with the completed warranty card and purchase receipt. If you sell or transfer ownership of this product, pass on these instructions to the new owner.

Always follow basic safety precautions and accident prevention measures when using an electrical appliance. The following statements you will see in this booklet have these meanings:

**WARNING:** Indicating information concerning your personal safety.

**CAUTION:** Indicating information on how to avoid damaging the appliance or cabinetry.

**IMPORTANT:** Indicating tips and information about use of the appliance.

## USAGE CONDITIONS AND RESTRICTIONS

- **Domestic use only:** This appliance is intended for indoor household use only. It is not intended for commercial, industrial or outdoor use. It is not intended for use in a recreational vehicle.
- **Purpose:** Do not use this appliance for anything other than its intended purpose. Other uses are not recommended and may cause fire, electric shock or personal injury.
- **Attachments:** The use of attachments is not recommended by the appliance manufacturer and distributor as they may be hazardous.
- **Improper use:** Damage due to improper use, or repairs made by unqualified personnel will void your warranty. We assume no liability for any eventual damages caused by misuse of the product or noncompliance with these instructions.

## BEFORE USING YOUR APPLIANCE

This manual explains the proper use of your new Esatto oven. Please read this manual carefully before using the product. This manual should be kept in a safe place for handy reference.

This oven is a domestic appliance which has been manufactured and tested to comply with Australian and New Zealand Standards.

This oven must only be installed in accordance with the instructions provided. Incorrect installation may cause harm to persons, damage property and void the product's warranty.

Read the following carefully to avoid damage or injury.

**IMPORTANT:** Check for any damage or marks. If you find the appliance is damaged or marked, you must report it within 7 days if you wish to claim for damage/ marks under the manufacturer's warranty. This does not affect your statutory rights.

## SAFETY INSTRUCTIONS

- Before the installation and use of the appliance, carefully read the supplied instructions.
- The manufacturer is not responsible if an incorrect installation and use causes injuries and damages.
- Always keep the instructions with your appliance for future reference.
- Do not use the oven unless you are wearing something on your feet. Do not touch the oven with wet or damp hands or feet.
- Some parts of appliance may keep its heat for a long time; it is required to wait for it to cool down before touching onto the points that are exposed to the heat directly.
- If you will not use the appliance for a long time, it is advised to turn the plug off.

**WARNING:** To prevent any damages to your and others' life or property, you have to follow the safety notes.

**WARNING:** Caution, risk of fire!

## CHILDREN & VULNERABLE PEOPLE SAFETY

**WARNING:** Risk of suffocation, injury or permanent disability.

- This appliance can be used by children aged from 8 years and above and persons with reduced physical, sensory or mental capabilities or lack of experience and knowledge if they have been given supervision or instruction for the operation of the appliance by a person who is responsible for their safety.
- Do not let children play with the appliance.
- Keep all packaging away from children.
- Keep all detergents away from children.
- Keep children and pets away from the appliance door when it is open.
- Do not allow children to go near the oven when it is operating, especially when the grill is on.
- Cleaning and user maintenance shall not be made by children without supervision.

## BEFORE INSTALLATION

- Remove all the packaging.
- Do not install or use a damaged appliance.
- Always move the appliance cautiously. Do not use the machine door or the handle of oven, to lift the appliance.
- When the oven is first switched on, it may give off an unpleasant smell. This is due to the bonding agent used for the insulating panels within the oven. Please run the new empty oven with the conventional cooking function, 250 °C for 90 minutes to clean oil impurities inside the cavity.
- During the first time use, it is completely normal that the oven will show slight signs of smoke and unpleasant odours. Please wait for the smell to clear before putting food into the oven.
- Please use this product under the open environment.
- The appliance and its accessible parts become hot during use. Care should be taken to avoid touching heating elements.
- If the surface is cracked, switch off the appliance to avoid the possibility of electric shock.
- During use, the appliance becomes very hot. Care should be taken to avoid touching heating elements inside the oven.
- Ensure that the appliance is switched off before replacing the oven lamp to avoid the possibility of electric shock.

- The means for disconnection must be incorporated in the fixed wiring in accordance with the wiring specifications.
- Accessible parts may become hot during use.
- An all-pole disconnection means must be incorporated in the fixed wiring in accordance with the wiring rules.
- The appliance must be installed by an authorised technician and put into use. The manufacturer is not responsible for any damage that might be caused by defective placement, and installation by unauthorised personnel. Please contact 1300 11 HELP (4357) to arrange an authorised technician.

## ELECTRICAL CONNECTION

**CAUTION:** Risk of fire and electrical shock!

- The appliance must be earthed.
- Make sure that the electrical information on the rating plate agrees with the power supply. If not, contact an electrician.
- Always use a correctly installed shockproof socket.
- Do not use any multi-plug adapters or extension cables.
- Connect the mains plug to the mains socket only at the end of the installation. Make sure that there is access to the mains plug after the installation. Do not connect the appliance plug with a power connection board.
- Do not pull the mains cable to disconnect the appliance. Always pull the mains plug.
- Do not touch the mains cable or the mains plug with wet hands.

**WARNING:** If the supply cord is damaged, it must be replaced by the manufacturer or its service agent or similarly qualified person in order to avoid a hazard.

**WARNING:** All electrical work must be done in accordance with local and national electrical codes as applicable and should be undertaken by licenced and qualified persons only. Failure to follow these instructions can result in death, fire or electrical shock.

# Safety Instructions (Continued)

## APPLIANCE USE

**WARNING:** Risk of fire, explosion, electric shock or damage to the appliance.

- Use this appliance in a household only.
- Do not change the specification of this oven.
- Do not sit or stand on the open door.
- Please do not close the machine door with excessive force
- When the door or drawer of oven is open do not leave anything on it, you may unbalance your appliance or break the door.
- The appliances are not intended to be operated by means of an external timer or separate remote control system.
- The instructions for ovens that have shelves shall include details indicating the correct installations of the shelves.

## CARE & CLEANING

**CAUTION:** Risk of injury or damage to the oven.

- Before maintenance, deactivate the appliance and disconnect the mains plug.
- Do not use a steam cleaner on the appliance.
- Clean the appliance with a moist soft cloth. Only use neutral detergents. Do not use abrasive products, abrasive cleaning pads, solvents or metal objects.
- Do not use harsh abrasive cleaners or sharp metal scrapers to clean the oven door glass since they can scratch the surface, which may result in shattering of the glass.

## UNPACKING

During transportation, protective packaging was used to protect the appliance against any damage. After unpacking, please dispose of all elements of packaging in a way that will not cause damage to the environment.

All materials used for packaging the appliance are environmentally friendly; they are 100% recyclable and are marked with the appropriate symbol.

**CAUTION:** During unpacking, the packaging materials (polythene bags, polystyrene pieces, etc.) should be kept out of reach of children.

## DISPOSAL OF THE APPLIANCE

- Disconnect the appliance from the mains supply.
- Cut off the mains cable and discard it.
- Remove the door catch to prevent children and pets to get closed in the appliance.

Old appliances should not simply be disposed of with normal household waste and should be delivered to a collection and recycling centre for electric and electronic equipment. A symbol shown on the product, the instruction manual or the packaging shows that it is suitable for recycling.

Materials used inside the appliance are recyclable and are labelled with information concerning this. By recycling materials or other parts from used devices you are making a significant contribution to the protection of our environment.

Information on appropriate disposal centres for used devices can be provided by your local authority.



## DECLARATION OF COMPLIANCE

When you have unpacked the oven, make sure that it has not been damaged in any way. If you have any doubts at all, do not use it: contact a professionally qualified person. Keep packing materials such as plastic bags, polystyrene, or nails out of the reach of children because these are dangerous to children.

# Installation Instructions

## FITTING THE OVEN INTO THE KITCHEN UNIT

Fit the oven into the space provided in the kitchen unit; it may be fitted underneath a work top or into an upright cupboard. Fix the oven in position by screwing into place, using the two fixing holes in the frame. To locate the fixing holes, open the oven door and look inside. To allow adequate ventilation, the measurements and distances adhered to when fixing the oven.

**IMPORTANT:** If the oven is to work properly, the kitchen housing must be suitable. The panels of the kitchen units that are next to the oven must be made of a heat resistant material. Ensure that the glues of units that are made of veneered wood can withstand temperatures of at least 120° C. Plastics or glues that cannot withstand such temperatures will melt and deform the unit, once the oven has been lodged inside the units, electrical parts must be completely insulated. This is a legal safety requirement. All guards must be firmly fixed into place so that it is impossible to remove them without using special tools. Remove the back of the kitchen unit to ensure an adequate current of air circulates around the oven. The hob must have a rear gap of at least 45mm.

Note:

- The cavity is not to include the power switch or socket.
- The oven & cabinet dimensions are in millimetres (mm)

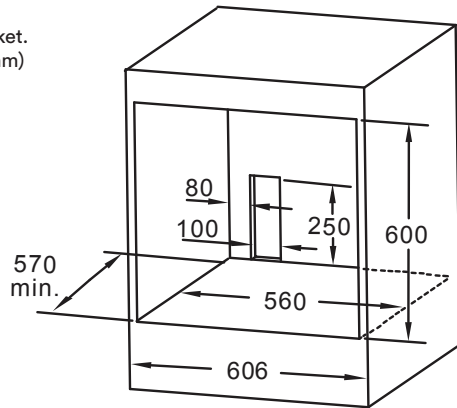
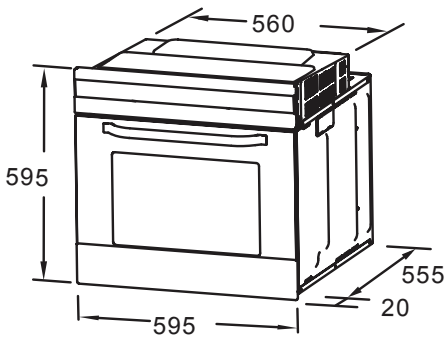

## SECURING THE OVEN TO THE CABINET

1. Fit oven into the cabinet recess.
2. Open the oven door and determine the location of the mounting screw holes.
3. Fix the oven to the cabinet with two screws..

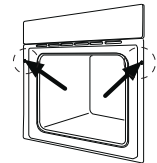

## CONNECTION OF THE OVEN

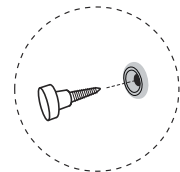
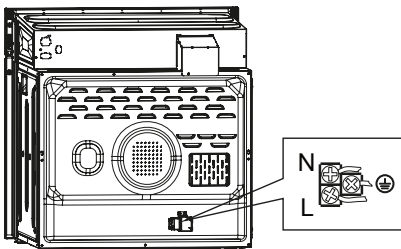

# Your Built-in Oven

## CONTROL PANEL

1. Function Knob
2. Timer Knob
3. Temperature Knob
4. Preheat Indicator

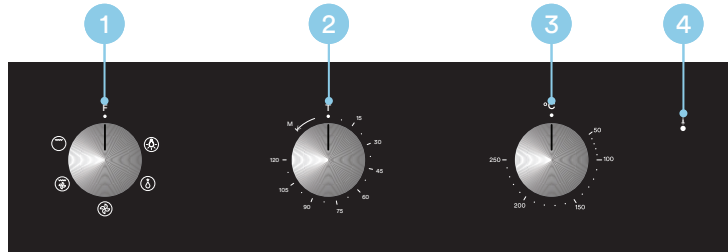

## ACCESSORIES

Your Esatto Built-in Oven is supplied with:

- **2 x Wire Shelves**  
For grill, dishes, cake pan with items for roasting and grilling
- **2 x Slider brackets**  
These shelf support rails on the right and left sides of the oven can be removed. Dishes and tray can be placed on the oven base, using the Grill & Max Grill and Fan functions.
- **1 x Baking Tray**  
For cooking large quantities of food such as cakes, pastries, frozen food etc, or for collecting fat/spillage and meat juices.

## SHELF PLACEMENT

To ensure the oven shelves operate safely, correct placement of the shelves between the side rail is imperative. Shelves and the pan only can be used between the first and fifth layers. The shelves should use with the right direction, it will ensure that during careful removal of the shelf or tray, hot food items should not slide out.

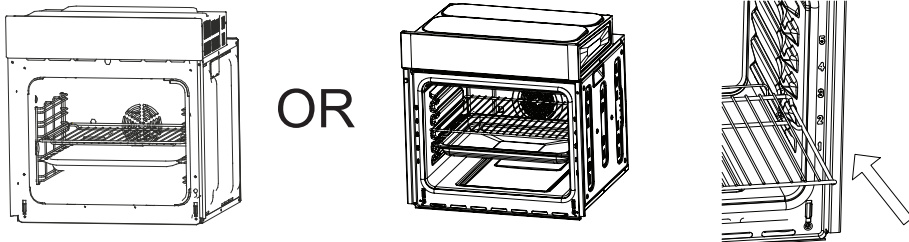





*Note: The images in this user manual are for reference only. Your appliance may appear differently.*



# Operating Instructions

## OVEN FUNCTIONS

SYMBOL	FUNCTION DESCRIPTION
	<b>Grill:</b> This cooking method is for everyday grilling, utilising only the inner grill element only, which directs heat downwards onto the food.
	<b>Grill &amp; Fan:</b> Utilising the inner grill element along with the fan, is suitable for grilling a large amount of cooking.
	<b>Convection:</b> Heat from the rear heating element circulated around the cavity by the fan. It is faster and economical than the conventional mode. This function also helps food cook faster whilst also reducing hot and cool spots and helping dishes on every shelf cook more evenly.
	<b>Defrost:</b> The circulation of air at room temperature enables quicker thawing of frozen food (without the use of any heating elements). It is a gentle but quick way to speed up the defrosting time and thawing of ready-made dishes, cream-filled produce, etc.
	<b>Oven Light:</b> This function enables the user to observe the progress of cooking without opening the door. The oven lamp will light for all cooking functions.

## BEFORE FIRST USE

- Before using the oven for the first time, read this manual thoroughly, even if you are familiar with this type of appliance. Pay particular attention to the safety instructions, installation instructions and operating instructions.
- After the appliance has been properly installed, and before first use, you should burn off any dust, oil or other remnants that may have been left inside the cavity from the manufacturing process or transportation. Please run the new empty oven with the conventional cooking function at 250° C for at least 90 minutes.

# Operating Instructions (Continued)

## MANUAL COOKING MODE

In manual cooking mode, the cooking duration is controlled by the user without a timer.

1. Rotate the Timer Knob counter clockwise to the “M” position to engage Manual Cooking mode. This will stop the oven from automatically powering off while in the “M” position.
2. Then turn the Temperature Knob and the Function Knob to your required settings.
3. Once you have finished cooking, turn all knobs back to their original “●” off positions.

## MINUTE MINDER MODE

Use the timer control knob to set the oven to power off after your set number of minutes.

Follow these steps to operate the oven in timer mode:

1. Rotate the Timer Knob clockwise to set your desired number of minutes (between 15 and 120 minutes).
2. Then turn the Temperature Knob and the Function Knob to your desired settings.
3. At the completion of the set duration, an alarm will sound to indicate that cooking is complete and the oven will automatically power off.

## VENTILATION

When cooking is finished, or in a paused or standby state, and if the oven cavity temperature is over 75 degrees, the cooling fan will operate for 15 minutes or until the oven cavity temperature become lower than 75 degrees.

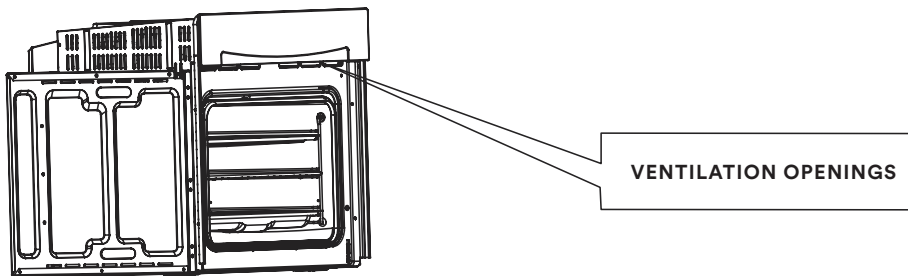

# Maintenance & Cleaning

## PRIOR TO CLEANING YOUR OVEN

### WARNING:

- Before any maintenance and cleaning, turn off the appliance and disconnect the power.
- Set all controls in the OFF position.
- Wait until the inside of the unit is not hot but only slightly warm—cleaning is easier than when warm.
- Clean the surface of the unit with a damp cloth, soft brush or fine sponge and then wipe dry.
- In case of heavy soiling, use hot water with non-abrasive cleaning product.
- For cleaning the oven door glass, do not use abrasive cleaners or sharp metal scrapers, as these can scratch the surface or lead to the glass being damaged.
- Never leave acidic substances (lemon juice, vinegar) on stainless steel parts.
- Do not use a high pressure cleaner for cleaning the unit.
- The baking tray and wire shelving may be washed in mild detergent.

## BULB REPLACEMENT

For replacement, follow the below process:

1. Disconnect power from the mains outlet or switch off the circuit breaker of the unit's mains outlet.
2. Unscrew the glass lamp cover by turning it counter-clockwise (note, it may be stiff) and replace the bulb with a new one of the same type.
3. Screw the glass lamp cover back in place.

### NOTE:

Only use 25W/230V , T300°C halogen lamps.

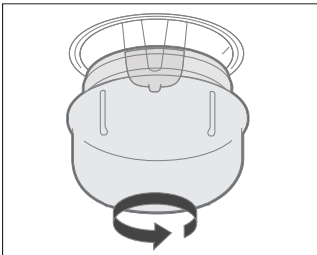

## REMOVING THE OVEN DOOR & INNER GLASS

The removable door allows for full access to the entire interior of the oven for easier and quicker maintenance. Follow these instructions carefully if you wish to remove the oven door.

1. To remove the door, open the door to the maximum angle. Then pull the buckle at the door hinges backward.

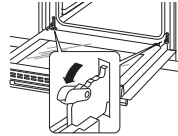

2. Close the door to an angle approximately 30°. Hold the door with one hand on each side. Lift up and slowly pull the door out from the oven.

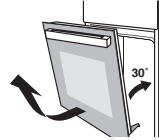

3. Open the door rotation bracket assembly, refer to image on the right.



4. Lift up the door outer glass and pull it out.

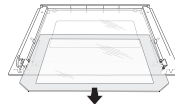

5. Then take the door middle glass out using the same method as step 4.

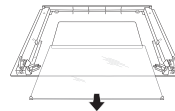

6. When cleaning is completed, reverse the above procedures to return the door to its original position.

### WARNING:

- Do not forcefully pull out the door or glass to prevent breaking the glass during dismantling.
- The hinge springs could become loose and cause personal injury.
- Do not lift or carry the oven door by the door handle.

# Troubleshooting

## OPERATION IN CASE OF EMERGENCY

In the event of an emergency you should:

- Set all controls in the OFF position and disconnect the power.
- Call After Sales Support on 1300 11 4357 or email support@residentiagroup.com.au

Some minor faults can be fixed by referring to the instructions given in the table below.

**IMPORTANT:** If your appliance appears to be operating incorrectly, then you should disconnect it from your electrical supply and then contact After Sales Support.

**WARNING:** Do not attempt to repair the oven yourself.

Please note that if a service agent is asked to attend whilst the product is under warranty and finds that the problem is not the result of an appliance fault, then you may be liable for the cost of the call out charge.

The appliance must be accessible for the service agent to perform any necessary repair.

If your appliance is installed in such a way that a service agent is concerned that damage will be caused to the appliance or your kitchen, then they will not complete a repair.

Please refer to the conditions of that appear on the warranty section at the rear of this user manual.

ISSUE	POSSIBLE CAUSE	COMMON RESOLUTIONS
The oven is not turning on.	Break in power supply.	Check the household fuse box for any blown fuses and replace as necessary. Also ensure that a safety switch hasn't tripped.
The oven light is not working.	The light globe is loose or has blown.	When the oven has cooled and is switched off, remove the globe cover and ensure that the globe is tightly secured. If blown, refer to the Cleaning and Maintenance section under Bulb Replacement.
The oven is burning the top of my dish whilst the underside is under-done.	Not enough heat from the bottom of the oven.	Try using the Conventional cooking functions. Try lowering the temperature. Try using a lower shelf position.
The oven is burning the underside of my dish whilst the top is under cooked.	Excessive heat from the bottom of the oven.	Try using the Conventional cooking functions. Try lowering the temperature. Try using a higher shelf position.
The oven is burning the outside of my dish whilst the inside is under-done.	Temperature is set too high.	Lower the oven temperature and increase the cooking duration.
The outside of my dish is too dry even though it looks cooked.	Temperature is set too low.	Increase the oven temperature and decrease the cooking duration.

If you need assistance, please contact our After Sales support centre on 1300 11 43 57 or email support@residentiagroup.com.au

# Technical Specifications

<b>Model</b>	EO605MB
<b>Gross Volume:</b>	80L
<b>Product Dimensions (W × D × H):</b>	595 × 575 × 595mm
<b>Weight (Net/Gross):</b>	32kg / 36kg
<b>Rated Voltage</b>	220-240V~
<b>Rated Frequency</b>	50Hz-60Hz
<b>Rated Power</b>	2.1kW
<b>No. of Functions</b>	5

**Attach your receipt  
to this page**



# Purchase Details

For your records, please record details of your purchase below and staple your receipt on the opposite page. Your serial number can be found on the rating plate of your Built-in Oven.

---

## STORE DETAILS

---

STORE NAME |

ADDRESS |

TELEPHONE |

PURCHASE DATE |

---

## PRODUCT DETAILS

---

MODEL NO. |

SERIAL NO.\* |

# Warranty

## WARRANTY TERMS AND CONDITIONS BUILT-IN OVENS

This document sets out the terms and conditions of the product warranties for Residentia Group Appliances. It is an important document. Please keep it with your proof of purchase documents in a safe place for future reference should you require service for your Appliance.

1. **IN THIS WARRANTY**
  - (a) 'acceptable quality' as referred to in clause 10 of this warranty has the same meaning referred to in the ACL;
  - (b) 'ACL' means Trade Practices Amendment (Australian Consumer Law) Act (No.2) 2010;
  - (c) 'Appliance' means any Residentia Group product purchased by you accompanied by this document;
  - (d) 'ASR' means Residentia Group authorised service representative;
  - (e) 'Residentia Group' means Residentia Group Pty Ltd of 165 Barkly Ave, Burnley VIC 3121, ACN 600 546 656 in respect of Appliances purchased in Australia;
  - (f) 'major failure' as referred to in clause 10 of this warranty has the same meaning referred to in the ACL and includes a situation when an Appliance cannot be repaired or it is uneconomic for Residentia Group, at its discretion, to repair an Appliance during the Warranty Period;
  - (g) 'Warranty Period' means:
    - (i) where the Appliance is used for personal, domestic or household use (i.e. normal single family use) as set out in the instruction manual, the Appliance is warranted against manufacturing defects for 24 months, following the date of original purchase of the Appliance;
  - (h) 'you' means the purchaser of the Appliance not having purchased the Appliance for re-sale, and 'your' has a corresponding meaning.
2. This warranty only applies to Appliances purchased and used in Australia and is in addition to (and does not exclude, restrict, or modify in any way) any non-excludable statutory warranties in Australia.
3. During the Warranty Period Residentia Group or its ASR will, at no extra charge if your Appliance is readily accessible for service, without special equipment and subject to these terms and conditions, repair or replace any parts which it considers to be defective. Residentia Group or its ASR may use remanufactured parts to repair your Appliance. You agree that any replaced Appliances or parts become the property of Residentia Group. This warranty does not apply to light globes, batteries, filters, seals or similar perishable parts.
4. Parts and Appliances not supplied by Residentia Group are not covered by this warranty.



5. You will bear the cost of transportation, travel and delivery of the Appliance to and from Residentia Group or its ASR. If you reside outside of the service area, you will bear the cost of:
  - (a) travel of an authorised representative;
  - (b) transportation and delivery of the Appliance to and from Residentia Group or its ASR, in all instances, unless the Appliance is transported by Residentia Group or its ASR, the Appliance is transported at the owner's cost and risk while in transit to and from Residentia Group or its ASR.
6. Proof of purchase is required before you can make a claim under this warranty.
7. You may not make a claim under this warranty unless the defect claimed is due to faulty or defective parts or workmanship. Residentia Group is not liable in the following situations (which are not exhaustive):
  - (a) the Appliance is damaged by:
    - (i) accident
    - (ii) misuse or abuse, including failure to properly maintain or service
    - (iii) normal wear and tear
    - (iv) power surges, electrical storm damage or incorrect power supply
    - (v) incomplete or improper installation
    - (vi) incorrect, improper or inappropriate operation
    - (vii) insect or vermin infestation
    - (viii) failure to comply with any additional instructions supplied with the Appliance;
  - (b) the Appliance is modified without authority from Residentia Group in writing;
  - (c) the Appliance's serial number or warranty seal has been removed or defaced;
  - (d) the Appliance was serviced or repaired by anyone other than Residentia Group, an authorised repairer or ASR.
8. This warranty, the contract to which it relates and the relationship between you and Residentia Group are governed by the law applicable where the Appliance was purchased.
9. To the extent permitted by law, Residentia Group excludes all warranties and liabilities (other than as contained in this document) including liability for any loss or damage whether direct or indirect arising from your purchase, use or non use of the Appliance.
10. For Appliances and services provided by Residentia Group in Australia, the Appliances come with a guarantee by Residentia Group that cannot be excluded under the Australian Consumer Law. You are entitled to a replacement or refund for a major failure and for compensation for any other reasonably foreseeable loss or damage. You are also entitled to have the Appliance repaired or replaced if the Appliance fails to be of acceptable quality and the failure does not amount to a major failure. The benefits to you given by this warranty are in addition to your other rights and remedies under a law in relation to the Appliances or services to which the warranty relates.
11. At all times during the Warranty Period, Residentia Group shall, at its discretion, determine whether repair, replacement or refund will apply if an Appliance has a valid warranty claim applicable to it.
12. Missing parts are not covered by warranty. Residentia Group reserves the right to assess each request for missing parts in a case by case basis. Any parts that are not reported missing in the first week after purchase will not provide free of charge.
13. To enquire about claiming under this warranty, please follow these steps:
  - (a) carefully check the operating instructions, user manual and the terms of this warranty;
  - (b) have the model and serial number of the Appliance available;
  - (c) have the proof of purchase (e.g. an invoice) available;
  - (d) telephone the numbers shown below.
14. You accept that if you make a warranty claim, Residentia Group and its ASR may exchange information in relation to you to enable Residentia Group to meet its obligations under this warranty.

#### IMPORTANT

Before calling for service, please ensure that the steps in point 13 have been followed.

#### CONTACT SERVICE

→ Service: 1300 11 HELP (4357)

The Australian Consumer Law requires the inclusion of the following statement with this warranty:

Our goods come with guarantees that cannot be excluded under the Australian Consumer Law. You are entitled to a replacement or refund for a major failure and for compensation for any other reasonably foreseeable loss or damage. You are also entitled to have the goods repaired or replaced if the goods fail to be of acceptable quality and the failure does not amount to a major failure.

# Warranty (NZ)

## NEW ZEALAND WARRANTY TERMS & CONDITIONS BUILT-IN OVENS

To help care for your investment, be sure to register your appliance online. Registration will help you if you need to arrange service in the future, and serves as a record of your purchase—including critical information like model number and serial number – that you can refer to at any time. Simply visit the below website, or ask your retailer for help: [www.esatto.house/nz/registration](http://www.esatto.house/nz/registration)

### WARRANTY

These products are covered by a warranty for a period of 24 months from the date of purchase, subject to the following conditions\*. The warranty covers rectification free of charge of any fault arising from defective materials or components, or faulty workmanship or assembly.

\* The conditions above mentioned are:

1. That the purchaser carefully follows all instructions packed with the product;
2. That the purchaser and/or installer carefully follows the installation instructions provided and complies with electrical wiring regulations, gas and/or plumbing codes;
3. That the purchaser carefully follows instructions provided in the owner's handbook relating to the proper use and care of the product and does not use the product for any purpose other than the domestic use for which it has been designed;
4. Commercial use of the product for professional or industrial purposes will void this warranty;
5. That the product was purchased and installed in New Zealand;
6. That this warranty does not extend to:
  - a) optional glass lids for hobs apart from claims which relate to mechanical or physical damage thereof at the date of purchase;
  - b) 'consumable' parts such as light bulbs or filters;
  - c) damage to ceramic glass caused by liquid or solid spill-overs, lack of maintenance, or impact;
  - d) damage to surface coatings caused by cleaning or maintenance using products not recommended by the owner's handbook;
  - e) defects caused by normal wear and tear, accident, negligence, alteration, misuse or incorrect installations;
  - f) a product dismantled, repaired or serviced by any serviceman other than an authorised service agent;
  - g) a product not in possession of the original purchaser;
  - h) damage caused by power outages or surges
  - i) damage caused by pests (eg. rats, cockroaches etc.)
7. That if the product is a freestanding microwave oven or small appliance it must be returned to the dealer/retailer for servicing. These products, unless stated otherwise, have a 12 month warranty from original date of purchase with 24 months on the microwave magnetron; Waste disposers have a 12 month warranty.
8. The provision of service under this warranty is limited by a 25km boundary from the retailer where the product was purchased except for microwaves. Such travelling outside of these limits will incur commercial cost to be paid by you, regulated by the number of kilometres travelled beyond the 25km limit (50km return trip). Microwaves are to be delivered to the nearest authorised service agent by the customer.

Please refer to your user manual for any further conditions that may apply to your specific model.

Nothing herein contained shall be construed in any way as excluding or limiting your rights under the Consumer Guarantees Acts 1993.

For Service please visit [www.applico.co.nz/service](http://www.applico.co.nz/service) or contact the dealer/retailer from whom you purchased the product from or call the 0800 number listed below. If you are unable to establish the date of purchase, or the fault is not covered by this warranty, or if the product is found to be in working order, you will be required to bear all service call charges.

Registration of this warranty constitutes acceptance of the terms and conditions of this warranty.

Should you require any assistance, please call Customer Services on 0800 763 448.

Distributed by Applico Ltd. [www.applico.co.nz](http://www.applico.co.nz) July 2019

After registering your appliance online, we recommend you fill out the below information for your reference and keep this warranty card in a safe place.





E2447

**esatto**  
everything  
you need



A RESIDENTIA  
GROUP INITIATIVE