

PLUMBERS INSTALLATION INSTRUCTIONS UNDERMOUNT SINK

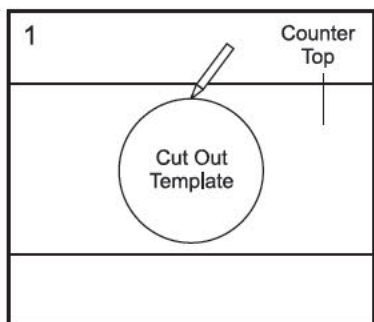

Place the cut out template into the desired sink location. Trace around the border of the template.

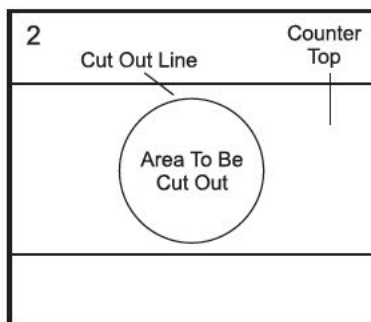

NOTE: BEFORE CUTTING, DOUBLE CHECK THE MEASUREMENTS OF YOUR TRACED LINE IS ACCURATE TO YOUR BOWL DIMENSIONS.

Use the appropriate cutting tool required for your counter top, cut along the line.

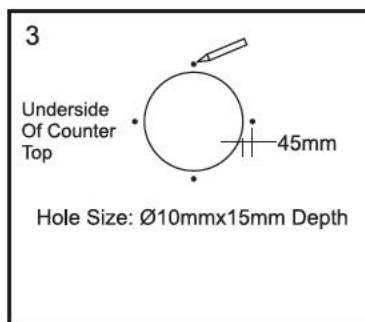

Drill into the underside of the counter top as shown in the diagram above.

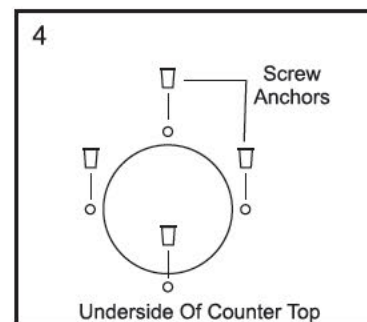

Insert each screw anchor into each drilled hole.

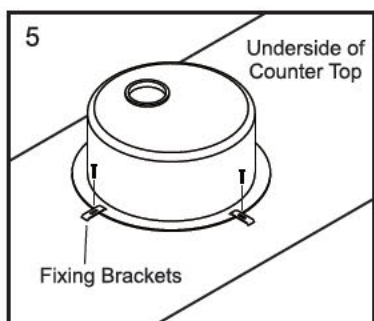

Place the fixing brackets over the screw anchor's and loosely tighten into position. Using the screws provided. Align sink into desired location.

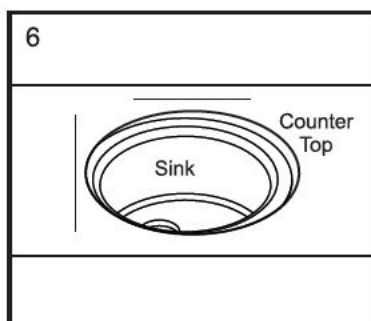

Check alignment over the counter top.

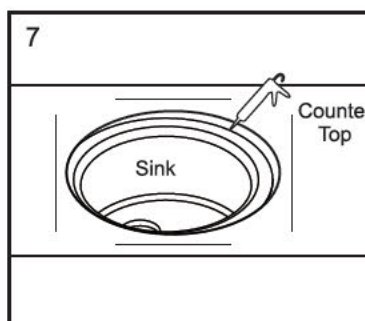

Apply suitable wet area sealant recommended for the stainless steel sink and counter top material.

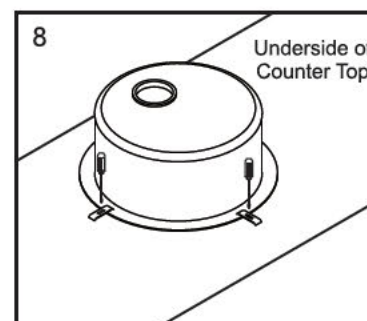

Lock the sink into the desired location. Be careful not to over tighten. Remove excess sealant.

CARE INSTRUCTIONS

For everyday cleaning of the sink, use household detergents suitable for stainless steel.

After each use, rinse the sink with warm water then wipe with a soft dry cloth.

- Do not use steel wool to clean your sink.
- Do not use chemical "silver cleaners", bleaches, or detergents containing chlorine or any of its derivatives.

WARNING!

- If the sink comes into contact with acidic materials, rinse immediately with plenty of water and wipe with a soft, dry cloth.
- Do not leave rusty objects in contact with the sink. Rust can cause staining, cracking or even permanent damage to the sink surface.
- To avoid staining of the surface do not leave food or other materials with corrosive properties such as juices, salt, vinegar mustard etc. on the sink for a long time.
- Do not place very hot objects directly on the sink. Place them on a special surface (board) made from wood or plastic, etc.
- Avoid scraping the sink basin or draining board with utensils.
- Avoid dropping heavy or sharp objects onto the sink surface.

NOTE: 10x sink clips for undermount are included with the sink, however only **6x** are required for installation. **4x** spare clips for installation provided. Clips should be spaced evenly.