



Tools and Materials Needed

- Mitre saw (recommended) or hacksaw with non-ferrous metal cutting blade
- Spirit level
- Measuring tape
- Drill
- Drill bits for timber: 10 mm
- Drill bits for metal: 3 mm, 5.5 mm
- Philips #1, #2, #3 driver bits
- Socket or nutsetter: 8 mm, 17 mm
- Adjustable spanner
- Clamps
- Painter's masking tape
- Dish soap (for glass panels)
- Non-corrosive exterior silicone caulking
- Anchoring fasteners (see pages 3-4)

Fasteners Supplied



Dear Customer,

We'd like to take a moment to say "thank you and congratulations" for choosing our products. At Peak® your satisfaction is very important to us. That is why we work very hard to provide you with products of exceptional quality, value, and beauty. And that is also why we want to hear from you.

Please contact us with your comments or suggestions at:
support@peakproducts.com.au • support@peakproducts.co.nz

Finally, we'd like to remind you to always work safely. Then, take pride, relax with your family and experience years of enjoyment with Peak® products.

Peak Products Corporation

IMPORTANT INFORMATION

- Before beginning work, read this installation guide in its entirety including all warnings and important information.
- This installation guide is updated occasionally. Please refer to the latest version at
<https://peakproducts.com/en-au/peak-aluminium-balustrade/installation-videos-guides/>
<https://peakproducts.com/en-nz/peak-aluminium-balustrade/installation-videos-guide/>
- Maximum post spacing:
decks: 1.80 m stairs: 1.75 m
- For commercial use including multi-residential housing, please contact Peak Customer Service at:
Australia: 1300 734 714 • support@peakproducts.com.au
New Zealand: 0800 800 040 • support@peakproducts.co.nz
- Complies* with: Australian/New Zealand Standard AS/NZS 1170.0:2002 Structural design actions
* Conditions apply. For details visit:
<https://peakproducts.com/en-au/peak-aluminium-balustrade/compliance/>
<https://peakproducts.com/en-nz/peak-aluminium-balustrade/compliance/>
Complete Peak® Aluminium Balustrade system required.
- Always understand and comply with your local building codes.
- To prevent timber splitting and rot, drill pilot holes and coat fastener screw threads with non-corrosive exterior silicone caulking.
- Ensure that the opening between each of the following is less than 100 mm:
 - balusters
 - balusters and posts
 - balusters and walls
 - balusters and glass panels
 - glass panels
 - glass panels and posts
 - glass panels and walls
 - base rail and deck surface

⚠WARNING No representation or warranty is given that your particular application of these products complies with relevant building codes or that the fasteners provided or used are appropriate for your application. Consult with professionals and local building officials before beginning work: (i) to ensure compliance with relevant building codes for your application and for your proposed use of fasteners; (ii) to ensure the integrity of the structural components in connection with which these products are to be used; (iii) to identify appropriate safety gear that is to be used during installation such as a safety harness when working above ground; (iv) to ensure that the work area is free from utilities, services and hazards; and (v) to clarify any instructions or warnings that may not be clear. Work in a safe manner wearing protective gear such as gloves, eyewear, headwear, footwear and clothing. When using tools comply with operation manuals and instructions. Metal and glass may have sharp edges and could fragment or splinter during or as a result of handling or cutting. Do not use these products in connection with any substance that is or may be harmful or corrosive to the products. Inspect and maintain these products and the structural components that they are used in connection with on a regular basis, using professionals when appropriate.

Peak Products Corporation shall not be liable for any loss or damage resulting from the improper installation or improper use of this product, subject to any contrary provision of the Australian Consumer Law in Australia or the Consumer Guarantees Act in New Zealand. Peak products and associated materials are protected by patents, designs, copyrights and/or trademarks used under license from Peak Innovations Inc.

ANCHORING FASTENERS FOR AUSTRALIA



⚠WARNING Engineering design has determined appropriate fasteners for the attachment of the post base, wall bracket, and base rail support to concrete or timber structures designed by others. While the types of material are defined in the table below, the ability of the supporting structure to provide adequate support to Peak® Aluminium Balustrade system and its fasteners must be independently verified for each installation. To meet certain balustrade load requirements within AS/NZS 1170.1:2002, use the fasteners specified in the tables below. Building codes may vary. Always understand and comply with your local building codes.

For further information visit: <https://peakproducts.com/en-au/peak-aluminium-balustrade/compliance/>

POST BASE Typical Anchoring Fasteners			
Deck Structure	Fasteners Required	Minimum Embedment ¹	Minimum End and Edge Distance
JD3 Timber e.g. Seasoned, Mixed Australia Hardwood	4 x M10 Coach Screw ²	100 mm	End of Joist: 50 mm Edge of Joist: 40 mm
J3 Timber e.g. Unseasoned, Mixed Australian Hardwood	4 x M10 Coach Screw ²	125 mm	End of Joist: 50 mm Edge of Joist: 40 mm
JD4 Timber e.g. Seasoned, Mixed Softwood Species	4 x M10 Coach Screw ²	145 mm	End of Joist: 50 mm Edge of Joist: 40 mm
J4 Timber e.g. Unseasoned, Pine, Radiata, Australia	4 x M10 Coach Screw ²	185 mm	End of Joist: 50 mm Edge of Joist: 40 mm
Concrete, Minimum strength 25 MPa	4 x Ramset™ WERCS Ankascrew™ or Ramset™ Ankascrew™, M10 x 100 mm	72 mm	70 mm

BASE RAIL SUPPORT Typical Anchoring Fasteners			
Deck Structure	Fasteners Required	Minimum Embedment ¹	Minimum End and Edge Distance
JD3, J3, JD4, J4 Timber e.g. Seasoned/Unseasoned Mixed Australian Hardwood, Mixed Softwood, Pine, Radiata, Australia	2 x 10g x 38 mm Screw (provided with product)	34 mm	End of Stud: 49 mm Edge of Stud: 25 mm
Concrete, Minimum strength 25 MPa	2 x Ramset™ Ankascrew™ M5 x 30 mm	27 mm	40 mm

WALL BRACKET Typical Anchoring Fasteners			
Deck Structure	Fasteners Required	Minimum Embedment ¹	Minimum End and Edge Distance
JD3, J3, JD4, J4 Timber e.g. Seasoned/Unseasoned Mixed Australian Hardwood, Mixed Softwood, Pine, Radiata, Australia	4 x 14g Type 17 Screw ³ or 4 x M6 Coach Screw ² (provided with product)	60 mm	End of Stud: 48 mm Edge of Stud: 24 mm
Concrete, Minimum strength 25 MPa	4 x Ramset™ WERCS Ankascrew™ or Ramset™ Ankascrew™, M6 x 50 mm	39 mm	50 mm

¹ Depth of the threaded portion of the screw into the innermost member.

² Material of steel coach screws shall be given in AS/NZS 4291.1, for property classes 4.6 and 4.8.

³ Material of 14g Type 17 screws shall be given in AS 3566.

ANCHORING FASTENERS FOR NEW ZEALAND



⚠WARNING Engineering design has determined appropriate fasteners for the attachment of the post base, wall bracket, and base rail support to concrete or timber structures designed by others. While the types of material are defined in the table below, the ability of the supporting structure to provide adequate support to Peak® Aluminium Balustrade system and its fasteners must be independently verified for each installation. To meet certain balustrade load requirements within AS/NZS 1170.1:2002, use the fasteners specified in the tables below. Building codes may vary. Always understand and comply with your local building codes.

For further information and more anchoring recommendations, visit:
<https://peakproducts.com/en-nz/peak-aluminium-balustrade/compliance/>

POST BASE Typical Anchoring Fasteners			
Deck Structure	Fasteners Required	Minimum Embedment ¹	Minimum End and Edge Distance
J1 Timber	4 x M10 Coach Screw ²	60 mm	End of Joist: 50 mm Edge of Joist: 40 mm
J2 Timber	4 x M10 Coach Screw ²	75 mm	End of Joist: 50 mm Edge of Joist: 40 mm
J3 Timber	4 x M10 Coach Screw ²	100 mm	End of Joist: 50 mm Edge of Joist: 40 mm
J4 Timber e.g. Unseasoned, Pine, Radiata, Australia	4 x M10 Coach Screw ²	145 mm	End of Joist: 50 mm Edge of Joist: 40 mm
J5 Timber e.g. Radiata Pine, Rimu, Douglas Fir, Larch	4 x M10 Coach Screw ²	215 mm	End of Joist: 50 mm Edge of Joist: 40 mm
Concrete, Minimum strength 25 MPa	4 x Ramset™ WERCS Ankascrew™ or Ramset™ Ankascrew™, M10 x 100 mm	72 mm	70 mm

BASE RAIL SUPPORT Typical Anchoring Fasteners			
Deck Structure	Fasteners Required	Minimum Embedment ¹	Minimum End and Edge Distance
J1, J2, J3, J4, J5 Timber e.g. Seasoned/Unseasoned, Pine, Radiata, Australia, Rimu, Douglas Fir, Larch	2 x 10g x 38 mm Screw (provided with product)	34 mm	End of Stud: 49 mm Edge of Stud: 25 mm
Concrete, Minimum strength 25 MPa	2 x Ramset™ Ankascrew™ M5 x 30 mm	27 mm	40 mm

WALL BRACKET Typical Anchoring Fasteners			
Deck Structure	Fasteners Required	Minimum Embedment ¹	Minimum End and Edge Distance
J1, J2, J3, J4, J5 Timber e.g. Seasoned/Unseasoned, Pine, Radiata, Australia, Rimu, Douglas Fir, Larch	4 x 14g Type 17 Screw ³ or 4 x M6 Coach Screw ² (provided with product)	40 mm	End of Stud: 60 mm Edge of Stud: 30 mm
Concrete, Minimum strength 25 MPa	4 x Ramset™ WERCS Ankascrew™ or Ramset™ Ankascrew™, M6 x 50 mm	39 mm	50 mm

¹ Depth of the threaded portion of the screw into the innermost member.

² Material of steel coach screws shall be given in AS/NZS 4291.1, for property classes 4.6 and 4.8.

³ Material of 14g Type 17 screws shall be given in AS 3566.

WALL BRACKET INSTALLATION

 This symbol indicates important information.

1 Measure and mark the position of all brackets on the wall.

 Maximum wall bracket spacing of 1.80 m.

2 For timber attachment, secure hand and base rail brackets to wall using four M6 coach screws with washers.

 To prevent timber rot, coat fastener screw threads with non-corrosive exterior silicone caulking.

 For concrete attachment, refer to pages 3-4 for anchoring fastener recommendations.

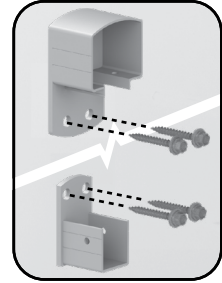
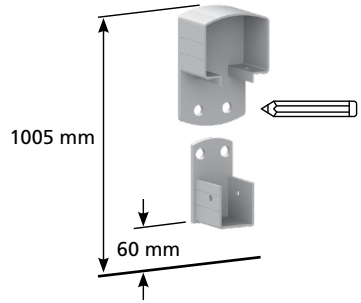

3 Follow the **Baluster**, **Glass Panel**, or **Sectional Glass** installation process as shown on pages 6-11.

HORIZONTAL ANGLE BRACKET INSTALLATION

 This symbol indicates important information.

1 Measure and mark the hole positions of all brackets on the post.

 Maximum post spacing of 1.80 m.

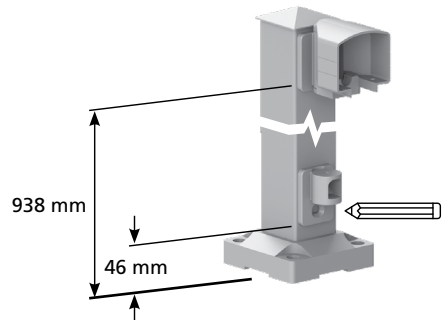

2 **A:** Drill 5.5 mm pilot holes at the marked locations.

B: Attach the hand and base rail brackets to the post using four 25 mm flat head screws. Then assemble the base rail bracket using the connector bolt.

3 Follow the **Baluster**, **Glass Panel**, or **Sectional Glass** installation process as shown on pages 6-11.

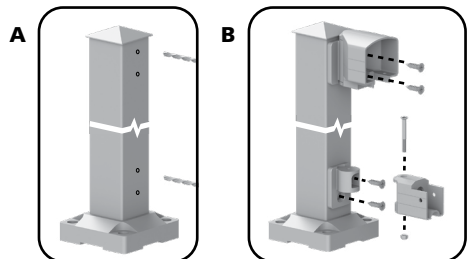

BALUSTER INSTALLATION

 This symbol indicates important information.

 For wall bracket or horizontal angle bracket installation, please see page 5.

1 Measure and mark the position of all posts and space equally.

 Maximum post spacing of 1.80 m.

Put the first post in position. For timber attachment, secure post to deck using four M10 coach screws (refer to pages 3-4 for required length) through each corner of the post base. Ensure that the post is plumb.

 To prevent splitting of deck boards, drill four 10 mm holes through deck boards (but not into deck structure).

 To prevent timber rot, coat fastener screw threads with non-corrosive exterior silicon caulking.

 For concrete attachment, refer to pages 3-4 for anchoring fastener recommendations.

2 Temporarily position the second post but do NOT secure it yet. Cut the hand and base rails and plastic baluster gaskets to fit between the posts.

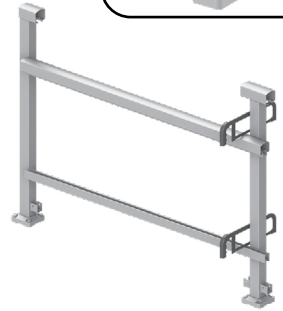
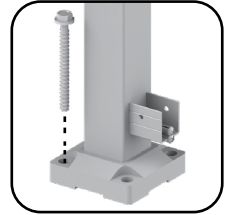

3 **A:** Install the base rail support into the bottom channel of the base rail.

 To ensure that the balusters remain engaged in the rails, you must install one base rail support for each balustrade section.

B: Install all but the last four spacers into each rail.

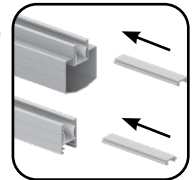
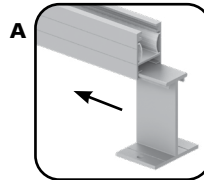

4 Insert the rails (fitted with plastic baluster gaskets) into the first post. Then insert the rails into the second post as a temporary support but do not secure it yet.

A: Secure the handrail to the first post with 19 mm pan head self-drilling screws.

B: Secure the base rail to the first post with 19 mm pan head self-drilling screws.

C: Slide the first spacer in each rail against the first post.

D: Insert a baluster into the base rail and swing the top of the baluster into the handrail. Repeat until you can no longer swing balusters into position.

 The opening between balusters, and between a baluster and a post, must not exceed 100 mm.

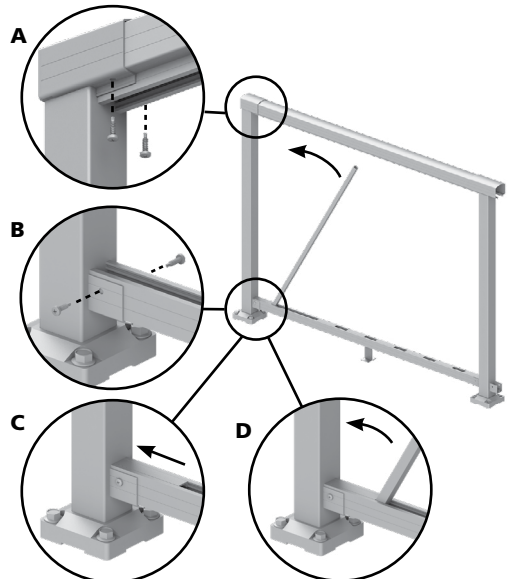

- 5** **A:** Remove the second post to install the last few balusters and spacers.
B: Cut the last spacers flush with the ends of the rails.

! To ensure equal baluster spacing at each post, cut the first and the last spacers in the hand and base rails to equal lengths.

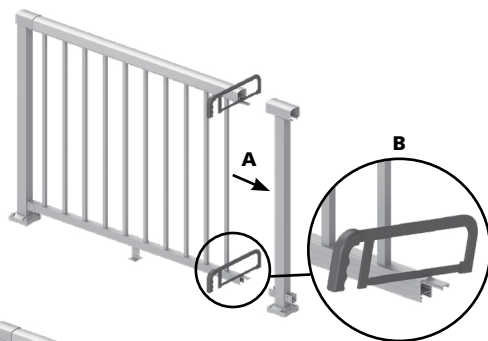

- 6** **A:** Insert the rails into the second post.
B: Position and fasten the second post in place, ensuring that the post is plumb (see step 1 for full details).

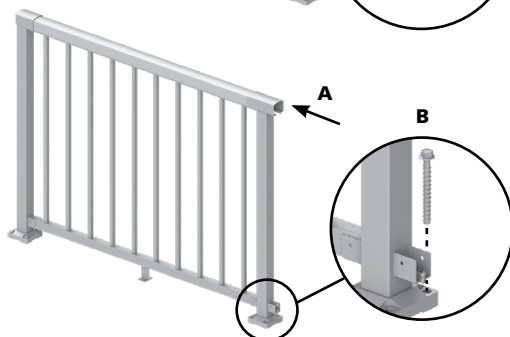

- 7** **A:** Secure the handrail to the second post with 19 mm pan head self-drilling screws.
B: Secure the base rail to the second post with 19 mm pan head self-drilling screws.
C: Slide the base rail support to the centre position.
D: For timber attachment, fasten the base rail support to the deck using two 38 mm pan head screws.

! For concrete attachment, refer to pages 3-4 for anchoring fastener recommendations.

! To ensure that the balusters remain engaged in the rails, you must install one base rail support for each balustrade section.

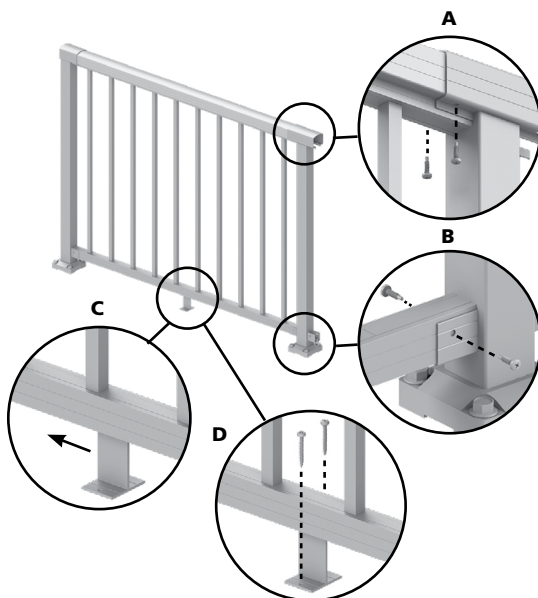

- 8** Repeat all steps for remaining sections.

! Optional: Install post base covers.

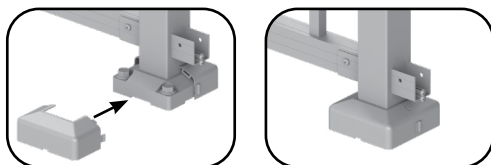

GLASS PANEL INSTALLATION

! This symbol indicates important information.

- !** Always use two people to handle glass panels. Always lift a glass panel by its sides. Toughened glass is extremely fragile – do not bump the edges. Always use protective gear including eyewear and gloves when handling glass panels.
- !** For wall bracket or horizontal angle bracket installation, please see page 5.

1 Measure and mark the position of all posts and space equally.

- !** Maximum glass width of 1025 mm and maximum post spacing:
1.80 m for sections with a glass panel and balusters.
1.20 m for sections with a glass panel only.

Put the first post in position. For timber attachment, secure post to deck using four M10 coach screws (refer to pages 3-4 for required length) through each corner of the post base. Ensure that the post is plumb.

- !** To prevent splitting of deck boards, drill four 10 mm holes through deck boards (but not into deck structure).
- !** To prevent timber rot, coat fastener screw threads with non-corrosive exterior silicon caulking.
- !** For concrete attachment, refer to pages 3-4 for anchoring fastener recommendations.



- 2**
- A:** Remove the plastic baluster gaskets from both rails.
 - B:** Temporarily position the second post but do NOT secure it yet. Cut the hand and base rails to fit between the posts.

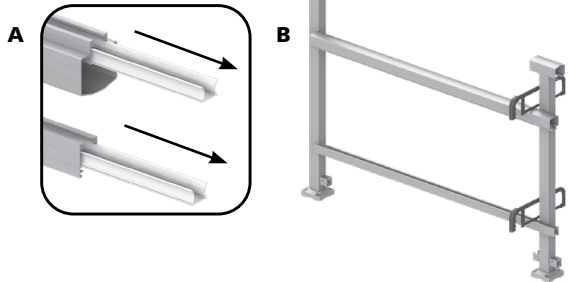

- 3**
- A:** Cut the glass gaskets the same length as the rails.
 - B:** Drill 3 mm holes into the base rail glass gasket (the smaller gasket) every 300 mm for water drainage.

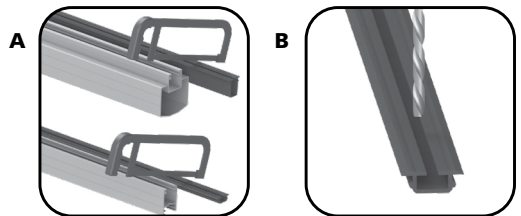

- 4**
- A:** Press the glass gaskets into the rails.
 - !** The smaller of the two glass gaskets goes into the base rail.
 - B:** Install the base rail support into the bottom channel of the base rail.
 - !** To ensure that the glass panel remains engaged in the rails, you must install one base rail support for each balustrade section.

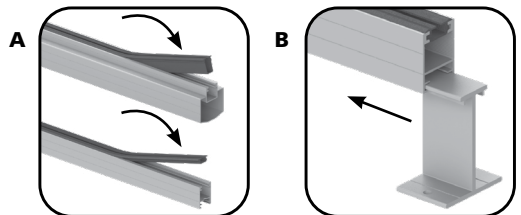

- 5** **A:** Insert the rails into the posts.
B: Position and fasten the second post in place, ensuring that the post is plumb (see step 1 for full details).
C: Slide the base rail support to the centre position.
D: For timber attachment, fasten the base rail support to the deck using two 38 mm pan head screws.

⚠ For concrete attachment, refer to pages 3-4 for anchoring fastener recommendations.

⚠ To ensure the glass panel remains engaged in the rails, you must install one base rail support for each balustrade section.

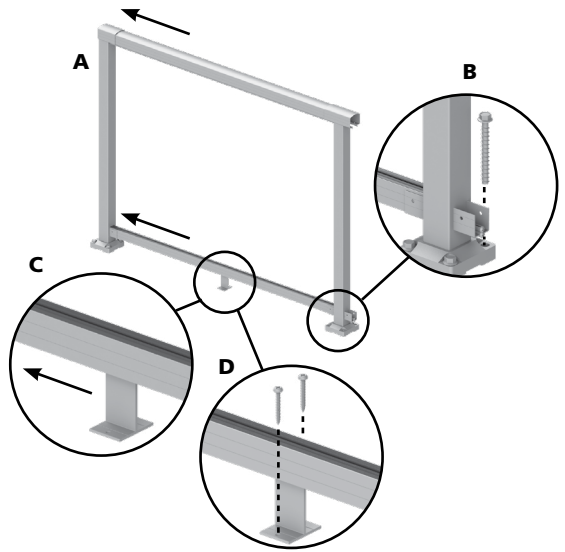

- 6** Secure the rails to both posts with 19 mm pan head self-drilling screws.

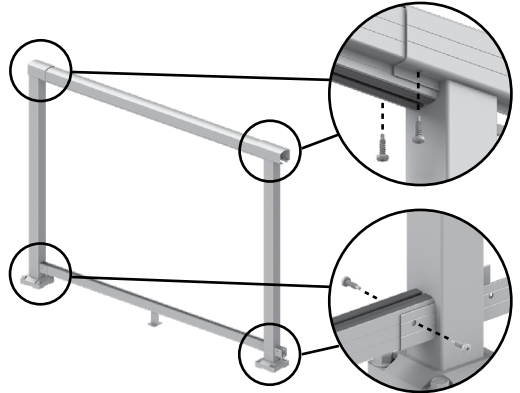

- 7** Install the glass panel by inserting it into the handrail gasket then lowering it into the base rail gasket.

⚠ Ensure that the glass gaskets and the top and bottom edges of the glass panel are well lubricated with liquid soap before installing the glass panel.

⚠ Ensure that the glass is fully seated in the gaskets. Wash away excess soap with clean water.

⚠ The opening between a glass panel and a post must not exceed 100 mm.

⚠ Maximum of one glass panel between posts.

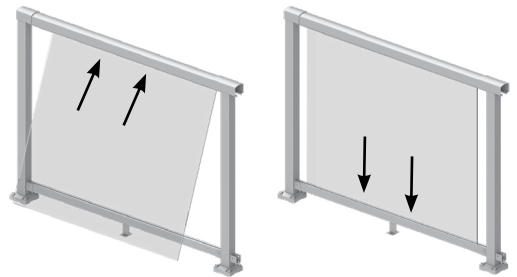

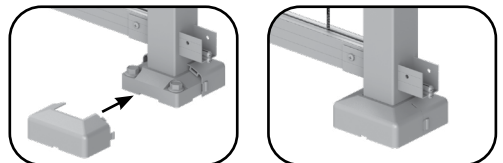

- 8** Repeat all steps for remaining sections.

⚠ Optional: Install post base covers.





SECTIONAL GLASS KIT INSTALLATION

-  This symbol indicates important information.
-  Always lift a glass panel by its sides. Toughened glass is extremely fragile – do not bump the edges. Always use protective gear including eyewear and gloves when handling glass panels.
-  For wall bracket or horizontal angle bracket installation, please see page 5.

1 Measure and mark the position of all posts and space equally.

-  Maximum post spacing of 1.80 m.

Put the first post in position. For timber attachment, secure post to deck using four M10 coach screws (refer to pages 3-4 for required length) through each corner of the post base. Ensure that the post is plumb.

-  To prevent splitting of deck boards, drill four 10 mm holes through deck boards (but not into deck structure).
-  To prevent timber rot, coat fastener screw threads with non-corrosive exterior silicon caulking.
-  For concrete attachment, refer to pages 3-4 for anchoring fastener recommendations.

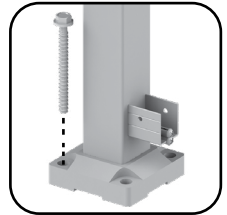

2 **A:** Remove the plastic baluster gaskets from both rails.
B: Temporarily position the second post but do NOT secure it yet. Cut the hand and base rails to fit between the posts.

-  This kit was designed to fit into a 1.80 m balustrade section. If your balustrade section is shorter than 1.80 m, you will need to cut the spacers or remove the glass panel(s) accordingly.

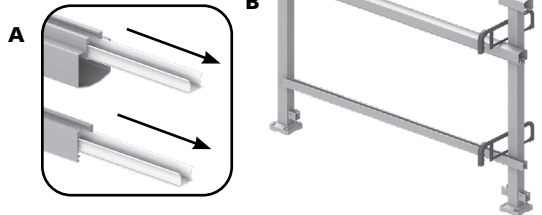

3 **A:** Install the base rail support into the bottom channel of the base rail.
 To ensure that the glass panels remain engaged in the rails, you must install one base rail support for each balustrade section.
B: Install the first pair of spacers in the hand and base rails.

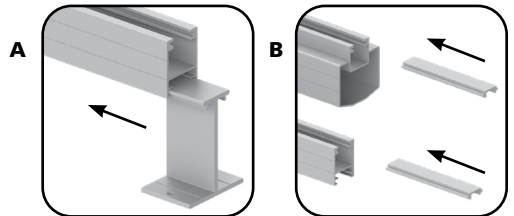

4 Insert the rails into the first post. Then insert the rails into the second post as a temporary support but do not secure it yet.
A: Secure the handrail to the first post using 19 mm pan head self-drilling screws.
B: Secure the base rail to the first post with 19 mm pan head self-drilling screws.
C: Slide the first spacer in each rail against the first post.

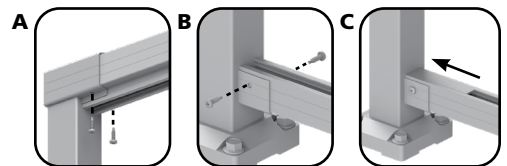

5 Remove the second post.
A: Attach the glass fittings to the top and bottom of each glass panel.

B: Slide a glass panel with fittings attached into the rails until touching the first pair of spacers. Then slide the second pair of spacers into the hand and base rails. Repeat to complete the section.

-  The opening between glass panels, and between a glass panel and a post, must not exceed 100 mm.

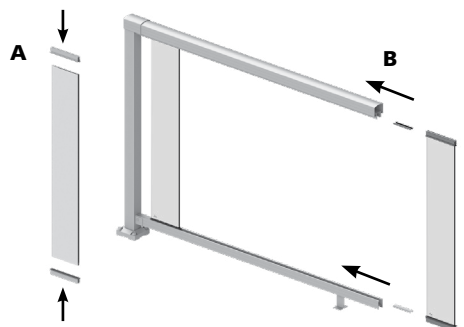

6 Cut the last spacers flush with the ends of the rails.

⚠ To ensure equal glass panel spacing at each post, cut the first and the last spacers in the hand and base rails to equal lengths.

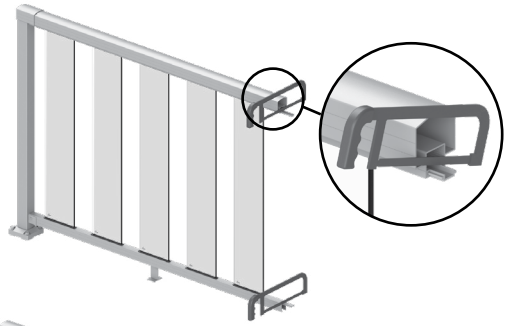

7 **A:** Insert the rails into the second post.
B: Position and fasten the second post in place, ensuring that the post is plumb (see step 1 for full details).

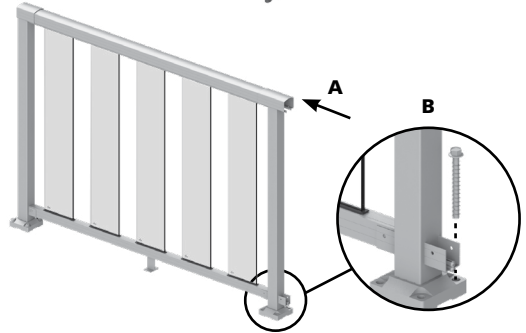

8 **A:** Secure the handrail to the second post with 19 mm pan head self-drilling screws.
B: Secure the base rail to the second post with 19 mm pan head self-drilling screws.
C: Slide the base rail support to the centre position.
D: For timber attachment, fasten the base rail support to the deck using two 38 mm pan head screws.

⚠ For concrete attachment, refer to pages 3-4 for anchoring fastener recommendations.

⚠ To ensure that the glass panels remain engaged in the rails, you must install one base rail support for each balustrade section.

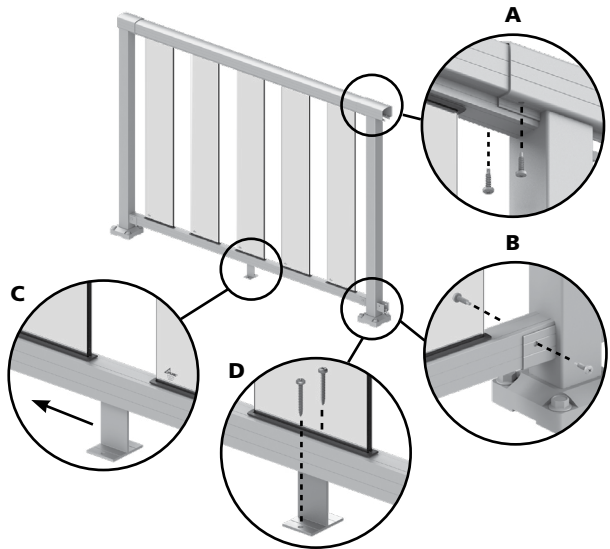

9 Repeat all steps for remaining sections.

⚠ Optional: Install post base covers.

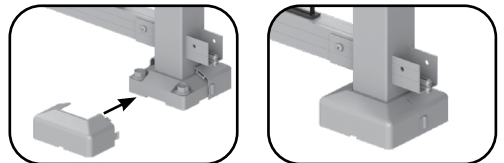

STAIR BALUSTER INSTALLATION

 This symbol indicates important information.

1 Measure and mark the position of all posts and space equally.

 Maximum post spacing of 1.75 m.

Put the first post in position. For timber attachment, secure post to deck using four M10 coach screws (refer to pages 3-4 for required length) through each corner of the post base. Ensure that the post is plumb.

 To prevent splitting of deck boards, drill four 10 mm holes through deck boards (but not into deck structure).

 To prevent timber rot, coat fastener screw threads with non-corrosive exterior silicon caulking.

 For concrete attachment, refer to pages 3-4 for anchoring fastener recommendations.

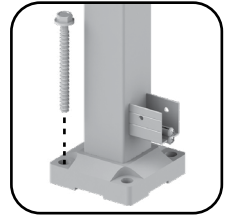

2 **A:** Remove the screw covers from the rails.

B: Insert a baluster through the first and last square slots at each end of the base rail (ensure the screw holes in the rails and balusters are facing up). Align the screw hole in each baluster with the screw hole in the base rail, then fasten each baluster to the rail using 12 mm pan head self-drilling screws.

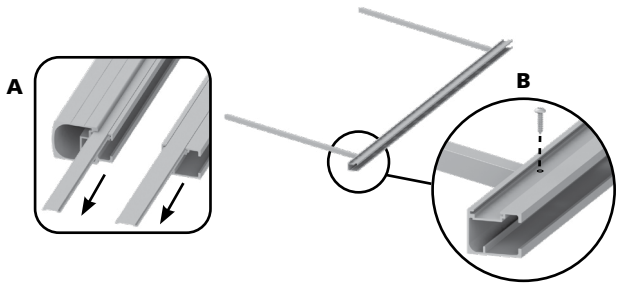

3 Insert the balusters into each end of the handrail (ensure the screw holes in the rail are facing up). Align the screw hole in each baluster with the screw hole in the handrail, then fasten each baluster to the rail using 12 mm pan head self-drilling screws.

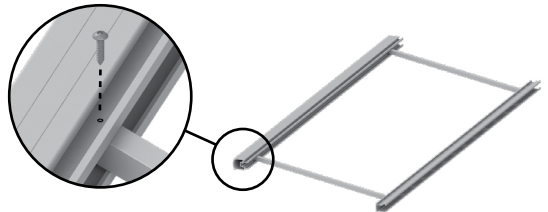

4 **A:** Insert the next baluster through the square slot in the base rail.

B: Insert baluster into the handrail and align the screw holes with the screw holes in the rails. Fasten baluster to the rails using 12 mm pan head self-drilling screws. Repeat to complete the panel.

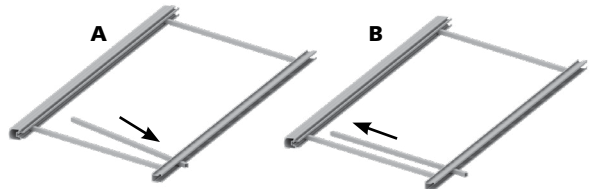

5 **A:** Install the handrail screw cover.

B: Install the base rail screw cover.

 Secure the screw covers to the rails with painter's masking tape to prevent them from sliding during the remainder of the installation.

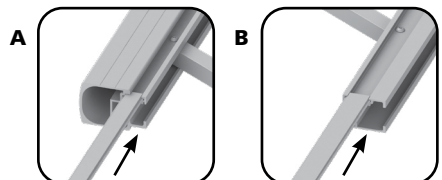

- 6** Put the balustrade panel and bottom post into position and clamp the posts and rails together but do not secure the bottom post yet. Ensure equal baluster spacing at each post, and that the bottom post is plumb. To allow space for the brackets, mark a vertical line 10 mm away from each post and cut the rails along the marked line.

! Always understand and comply with your local building codes for stair rail height, size of openings under the base rail, between balusters, and between a baluster and a post.

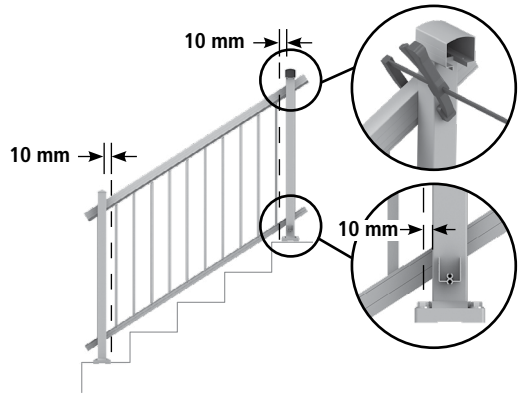

- 7** **A:** Reposition the balustrade panel in between the posts at the required height above the noses of the treads. Place and mark positions of each base rail bracket. Then remove the panel in order to mark hole positions for each bracket on the posts.
B: Drill 5.5 mm pilot holes through the post at the marked positions.
C: Fasten the base rail brackets to the posts, using four 25 mm flat head screws.
D: Position and fasten the bottom post in place, ensuring that the post is plumb (see step 1 for full details).

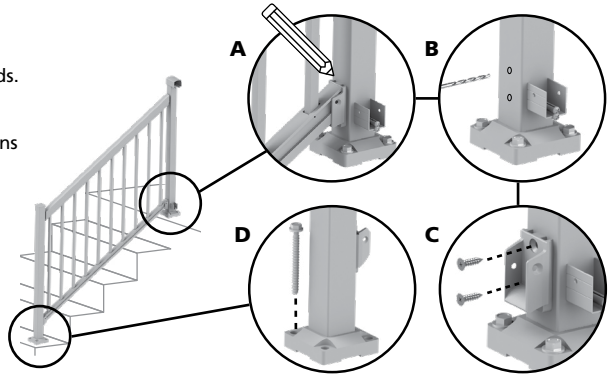

- 8** **A:** Temporarily position the balustrade panel in the base rail brackets and mark the position of the bracket and hole positions of each handrail bracket on the posts.
B: Drill 5.5 mm pilot holes through the post at the marked positions.
C: Fasten the handrail brackets to the posts, using four 25 mm flat head screws.

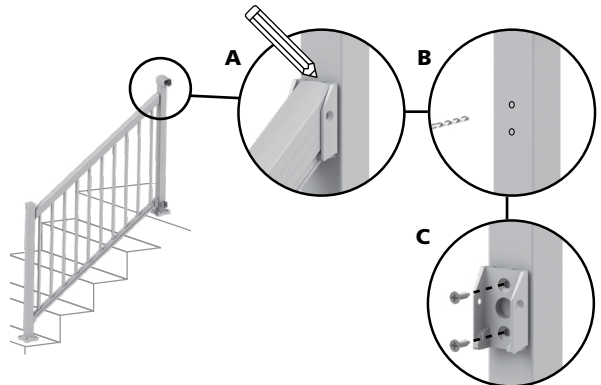

- 9** **A:** Reposition the balustrade panel, then drill 3 mm pilot holes through the rails at the screw positions.
B: Attach the balustrade panel to the brackets and secure with 19 mm flat head screws.
C: Slide a screw cover over each bracket.

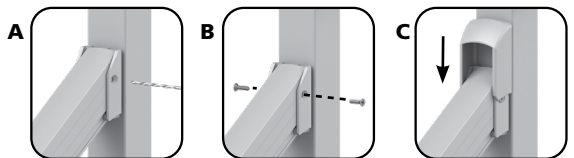

- 10** Repeat all steps for remaining sections.

! Optional: Install post base covers.

GATE INSTALLATION

 This symbol indicates important information.

 Before beginning work, measure and ensure the Gate Opening (W) does not exceed 1150 mm. Then please carefully follow the steps below to ensure the gate is not cut too short for your project.

- 1**
- A:** Remove latch side of gate frame.
 - B:** With latch side of gate frame removed, cut top and bottom gate rails 190 mm shorter than gate opening W.

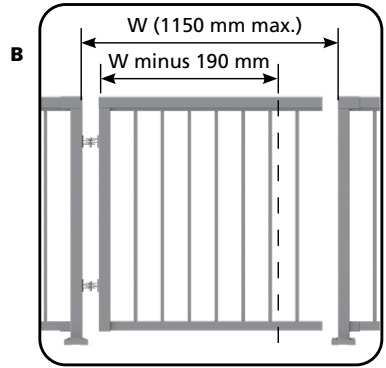
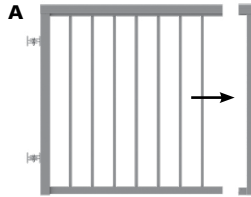

- 2**
- Attach the latch side of the gate frame using the 19 mm pan head self-drilling screws.

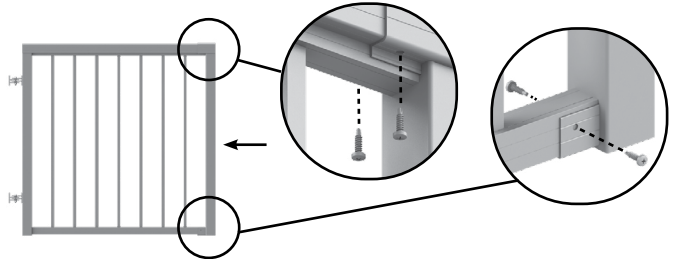

- 3**
- A:** Align the top of the gate with the top of the post and mark the hole positions for the hinges on the post.
 - B:** Drill 5.5 mm pilot holes at the marked positions.
 - C:** Install the top 50 mm coach screw on each hinge.
 - D:** Install the bottom 50 mm coach screw on each hinge by releasing the bolt and nut (HINT: do not completely disassemble hinge).

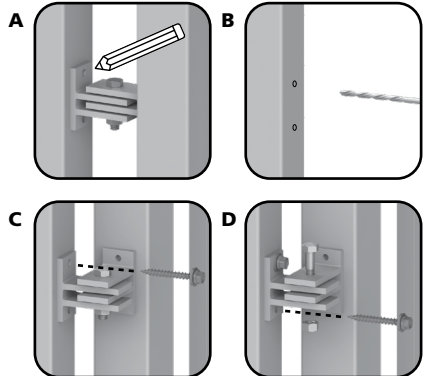

- 4**
- Use 19 mm pan head self drilling screws for these steps:
 - A:** Secure the retainer to the gate at the marked position.
 - B:** Insert the latch through the retainer.
 - C:** Secure the latch to the gate at the marked position.
 - D:** Check and mark the position for the latch plate on the post. Secure the latch plate to the post.

