

ozito

TABLE SAW WITH STAND

2000W

ASSEMBLY MANUAL

STANDARD EQUIPMENT

- | | |
|---------------------------|----------------------------|
| 1. Table Saw | 12. 10 / 13mm Spanner |
| 2. 254mm Saw Blade | 13. 36 x Bolts |
| 3. Riving Knife | 14. 4 x Foot Caps |
| 4. Sliding Mitre Gauge | 15. 2 x Bracing Brackets |
| 5. Small Hex Nuts | 16. 2 x Short Table Struts |
| 6. Small Hex Bolt | 17. 2 x Long Table Struts |
| 7. 4 x Frame Legs | 18. 2 x Table Extensions |
| 8. 4 x Cross Braces | 19. Push Stick |
| 9. 4 x Table Cross Braces | 20. Rip Fence |
| 10. 20 x Nuts | 21. Blade Guard |
| 11. 10 / 21mm Spanner | |

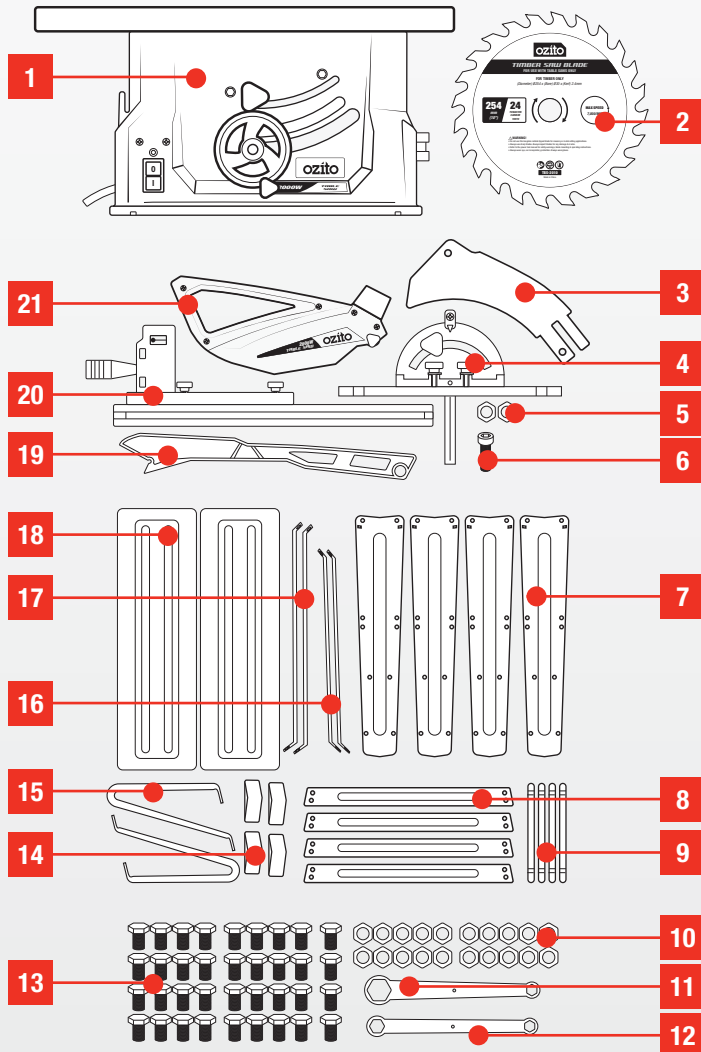

ONLINE MANUAL

Scan this QR Code with your mobile device to take you to the online manual.



3 YEAR REPLACEMENT WARRANTY*

1. ASSEMBLING THE FRAME



WARNING! ENSURE THE TOOL IS TURNED OFF AND DISCONNECTED FROM THE POWER SUPPLY BEFORE PERFORMING ANY OF THE FOLLOWING OPERATIONS.

1. Ensure the blade height is wound fully down and then turn the table saw upside down on the floor.

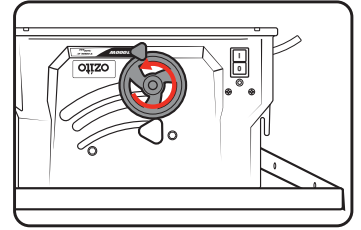

2. Remove any cardboard boxes from behind the motor; it can be easily accessed by tilting the blade using the bevel adjustment dial.

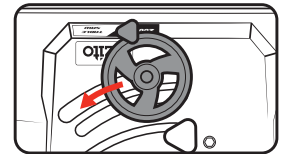

3. Align a table leg with the bolt holes on the table saw and attach it loosely with 2 of the bolts. Repeat this for the other 3 legs.

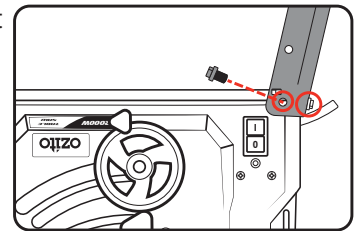

Note: Some of these bolts will need to be removed later, so only attach loosely.

4. Place the flat side of a cross brace against the inside face between 2 legs. Use 4 bolts and nuts to secure the brace in place. Repeat the same procedure for the other 3 cross braces.

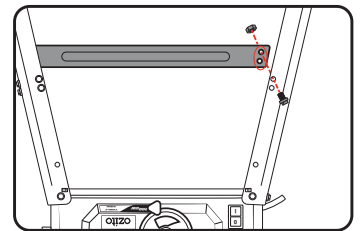

Note: Only fully tighten the bolts and nuts once the machine has been fully assembled, flipped onto its feet and placed on a level surface to ensure the frame is level.

5. Fit the rubber foot caps onto the ends of the legs.

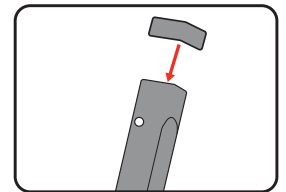

6. Use 2 bolts and nuts to attach a bracing bracket to one of the rear legs. Repeat for the other bracing bracket and rear leg.

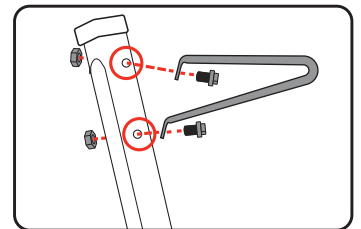

7. To assemble the push stick holder, screw one of the small nuts onto the small hex bolt.

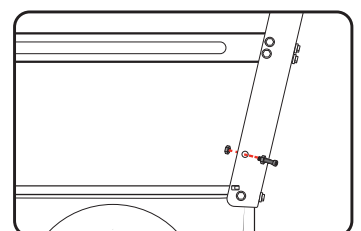

8. Place this through one of the holes on either of the front legs and use the other small nut to secure this in place.

Note: Unwind the hex bolt slightly if there is not enough space for the push stick to hand securely.

2. ATTACHING THE TABLE EXTENSIONS

1. With the table saw still upside down on a flat surface, align a table extension with the side of the table saw.

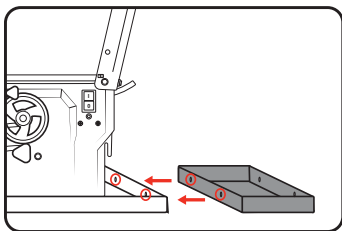

2. Place a cross brace on the extension piece and align it with the bolt holes in the table extension.

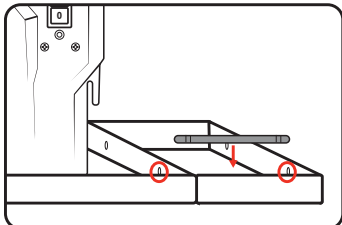

3. Use a bolt to secure the table extension and table cross brace to the table saw.

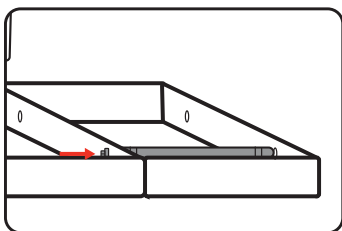

4. Repeat steps 2 and 3 for the other cross brace and then attach the other table extension in the exact same manner.

5. Use another bolt to attach a table strut to the outside of the table extension. Repeat for the other 3 table struts.

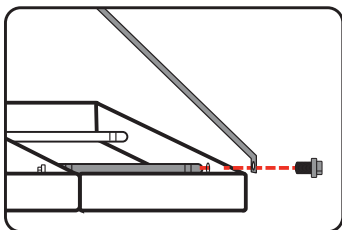

Note: One pair of table struts is longer than the other. The longer pair of table struts should be used on the side of the table saw with the power cord.

6. Undo the bolt on the table leg side and use this to secure a table strut against the table leg & saw. Repeat for the other 3 table struts.

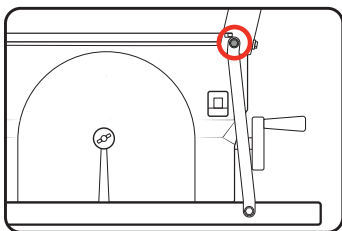

7. Flip the table saw onto its feet and tighten up all of the bolts.

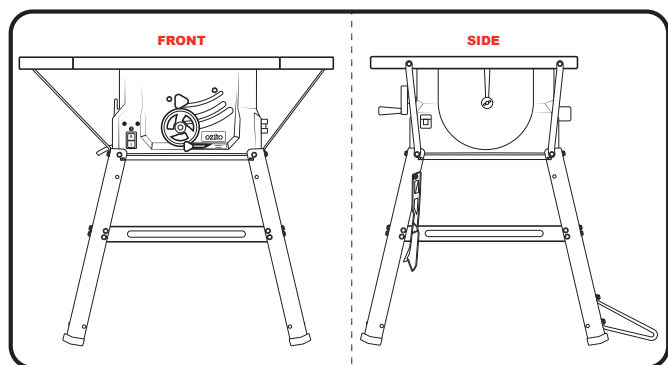

3. FITTING THE BLADE ASSEMBLY

1. Use a Philips head screwdriver (not supplied) to loosen and remove the table insert.

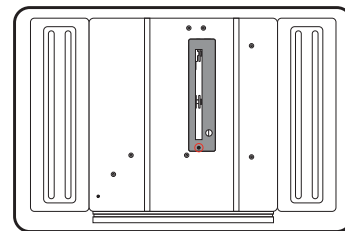

2. Remove the blade bolt. Use 21mm and 13mm spanners to loosen it if necessary.

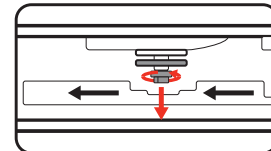

3. Remove the outer flange.

4. Thread the saw blade onto the axle and then replace the outer flange and bolt.

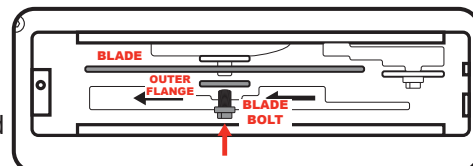

Note: Ensure the rotation arrows on the blade matches the direction of the guide arrows in the blade cavity.

Note: Ensure that the inner flange is attached to the motor shaft.

5. Use the 21mm spanner to hold the axle while using the 13mm spanner to tighten the bolt.

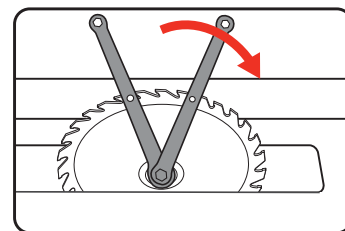

6. Use the 13mm spanner to loosen the riving knife plate.

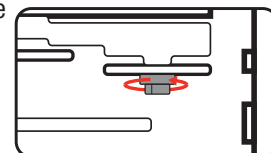

7. Slot the riving knife behind the plate, leaving a 3-8mm gap between the riving knife and blade teeth.

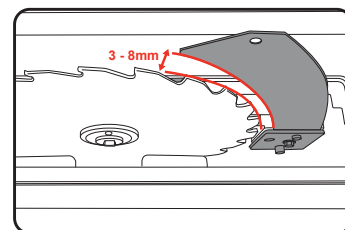

8. Retighten the bolt to secure the riving knife in place.

9. Replace the table insert by sliding the back end in first under the lip of the blade cavity, then redoing the Philips head screw.

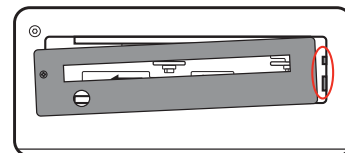

10. Slide the blade guard over the riving knife, aligning the bolt with the hole in the riving knife. Turn the bolt clockwise to lock it in place.

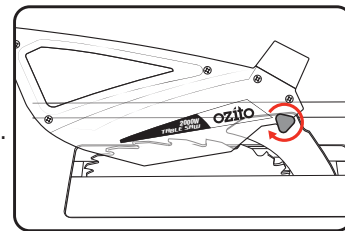

WARNING! THE BLADE GUARD MUST ALWAYS BE LOWERED OVER THE WORKPIECE BEFORE BEGINNING TO CUT.

ozito

TABLE SAW WITH STAND

2000W

INSTRUCTION MANUAL

SPECIFICATIONS

Mains Voltage:	230–240V ~ 50Hz
Input Power:	1800W; 2000W (S6 40%)
No Load Speed:	5,000/min
Blade:	Ø254 x Ø30mm x 2.8mm
Blade Teeth:	24TCT
Bevel Angle:	0 - 45° Left
Blade Height:	0 - 85mm
Max. Cutting Capacity:	85mm @ 90°; 65mm @45°
Table Size:	563 x 583mm 893 x 583mm (with extensions)
Dust Port:	Ø35mm
Weight:	18.8kg

ozito.com.au

3 YEAR
REPLACEMENT
WARRANTY*

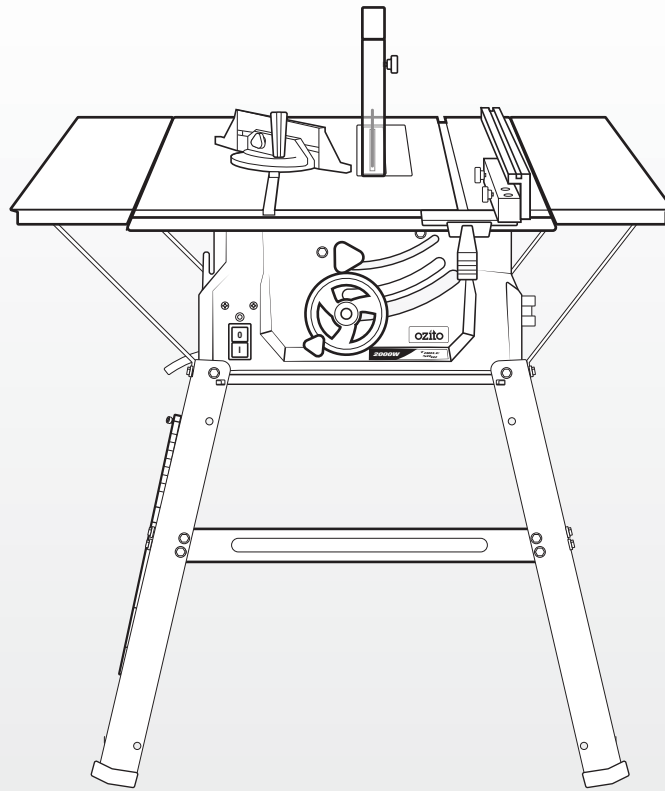

STANDARD EQUIPMENT

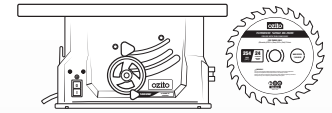
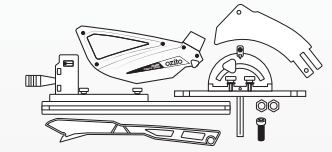
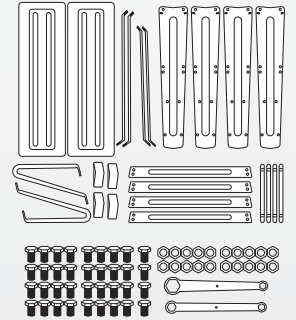

Table Saw & 254mm Blade



Blade Guard, Rip Fence, Sliding Mitre Gauge, Push Stick, Hex Bolt & 2 x Small Nuts



2 x Table Extensions, Base Frame Components, Assembly Fasteners & 2 x Spanners

TBS-2010

WARRANTY

IN ORDER TO MAKE A CLAIM UNDER THIS WARRANTY YOU MUST RETURN THE PRODUCT TO YOUR NEAREST BUNNINGS WAREHOUSE WITH YOUR BUNNINGS REGISTER RECEIPT. PRIOR TO RETURNING YOUR PRODUCT FOR WARRANTY PLEASE TELEPHONE OUR CUSTOMER SERVICE HELPLINE:

Australia: 1800 069 486
New Zealand: 0508 069 486

TO ENSURE A SPEEDY RESPONSE PLEASE HAVE THE MODEL NUMBER AND DATE OF PURCHASE AVAILABLE. A CUSTOMER SERVICE REPRESENTATIVE WILL TAKE YOUR CALL AND ANSWER ANY QUESTIONS YOU MAY HAVE RELATING TO THE WARRANTY POLICY OR PROCEDURE.

The benefits provided under this warranty are in addition to other rights and remedies which are available to you at law.

Our goods come with guarantees that cannot be excluded at law. You are entitled to a replacement or refund for a major failure and for compensation for any other reasonably foreseeable loss or damage. You are also entitled to have the goods repaired or replaced if the goods fail to be of acceptable quality and the failure does not amount to a major failure.

Generally you will be responsible for all costs associated with a claim under this warranty, however, where you have suffered any additional direct loss as a result of a defective product you may be able to claim such expenses by contacting our customer service helpline above.

3 YEAR REPLACEMENT WARRANTY*

Your product is guaranteed for a period of **36 months from the original date of purchase**. If a product is defective it will be replaced in accordance with the terms of this warranty. Warranty excludes consumable parts, for example: valve adapters and accessories.

*This product is intended for DIY use only and replacement warranty covers domestic use.

WARNING

The following actions will result in the warranty being void.

- If the tool has been operated on a supply voltage other than that specified on the tool.
- If the tool shows signs of damage or defects caused by or resulting from abuse, accidents or alterations.
- Failure to perform maintenance as set out within the instruction manual.
- If the tool is disassembled or tampered with in any way.
- Professional, industrial or high frequency use.

KNOW YOUR PRODUCT

TABLE SAW

- | | |
|------------------------|----------------------------|
| 1. Table Extension | 13. Safety Overload Switch |
| 2. Table | 14. Table Strut |
| 3. Sliding Mitre Gauge | 15. Blade Guard |
| 4. Mitre Lock | 16. Riving Knife |
| 5. Table Insert | 17. Dust Extraction Port |
| 6. Rip Fence | 18. Frame Leg |
| 7. Mitre Gauge Storage | 19. Frame Cross Brace |
| 8. Rip Fence Lever | 20. Frame Bracing Bracket |
| 9. Bevel Lock | 21. Push Stick |
| 10. Adjustment Wheel | 22. Push Stick Storage |
| 11. On/Off Switch | 23. Spanner Storage |
| 12. Power Cord | 24. Blade |

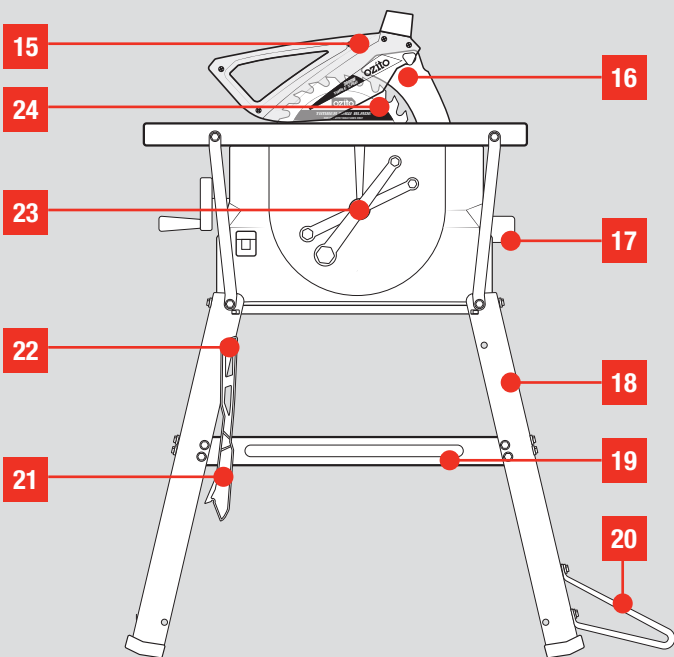
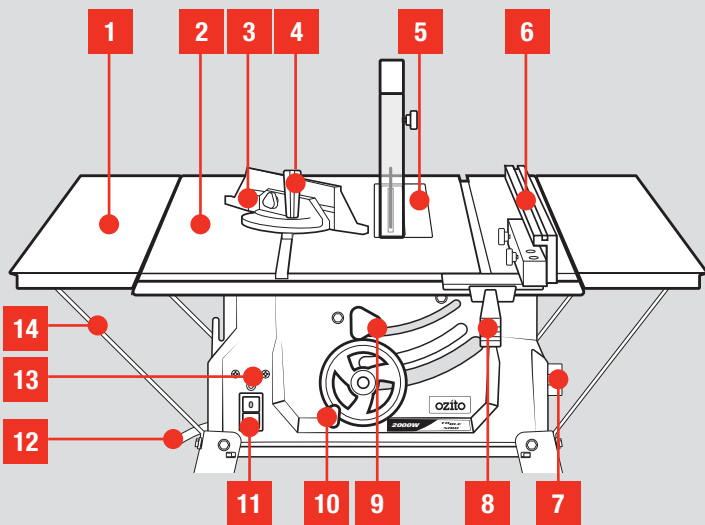

ONLINE MANUAL

Scan this QR Code with your mobile device to take you to the online manual.



3 YEAR REPLACEMENT WARRANTY*

SETUP & PREPARATION

1. ADJUSTMENTS

For detailed assembly instructions see **Assembly Manual**.

WARNING! ENSURE THE TOOL IS TURNED OFF AND DISCONNECTED FROM THE POWER SUPPLY BEFORE PERFORMING ANY OF THE FOLLOWING OPERATIONS.

WARNING! AFTER EVERY NEW ADJUSTMENT WE RECOMMEND YOU MAKE A TRIAL CUT IN A SCRAP PIECE OF MATERIAL IN ORDER TO CHECK THE NEW SETTINGS.

Setting The Cutting Depth

The depth should be adjusted so that no more than one tooth is protruding through the timber. This helps to minimise splintering.

1. To lower the blade for a smaller depth of cut, rotate the adjustment wheel anti-clockwise.

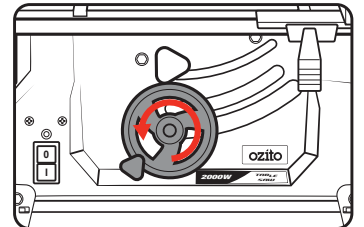

2. To raise the blade for a larger depth of cut, rotate the adjustment wheel clockwise.

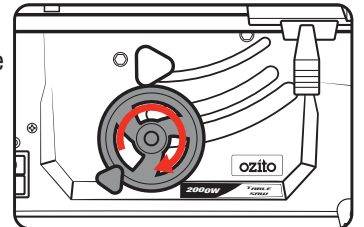

Setting The Bevel Angle

WARNING! THIS TOOL IS NOT INTENDED FOR CHANNEL OR TRENCH CUTS.

1. Loosen the bevel lock by rotating anti-clockwise.

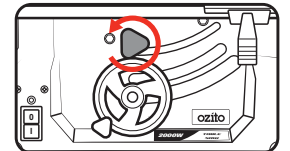

2. Slide the adjustment wheel to the desired angle using the bevel scale as a guide.

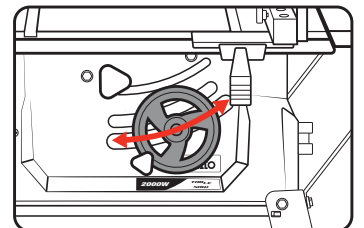

3. Secure the bevel angle by rotating the bevel lock clockwise.

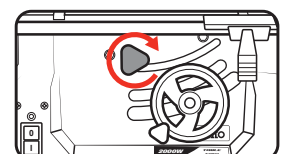

2. SETTING THE RIP FENCE



WARNING! ENSURE THE TOOL IS TURNED OFF AND DISCONNECTED FROM THE POWER SUPPLY BEFORE PERFORMING ANY OF THE FOLLOWING OPERATIONS.

Rip Fence Stop Height

The rip fence supplied with the table saw has two different guide faces. 1 for thick material and 1 for thin material.

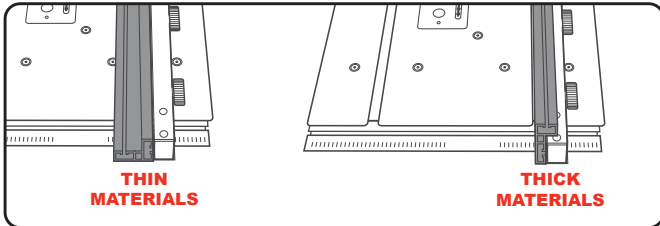

1. To change the stop rail, loosen the 2 screws.

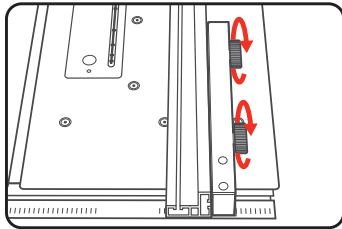

2. Slide the stop rail off and re-insert into the desired rail.

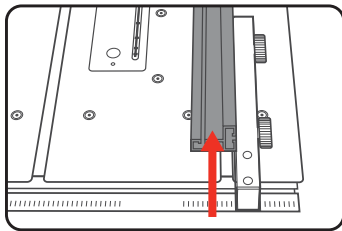

Note: The screws can also be removed and re-inserted from the other direction so that the flat guide face is on the opposite side.

3. Tighten the 2 screws to lock in place.

Setting the Stop Length

The stop rail can be moved in a longitudinal direction in order to prevent the workpiece from becoming jammed.

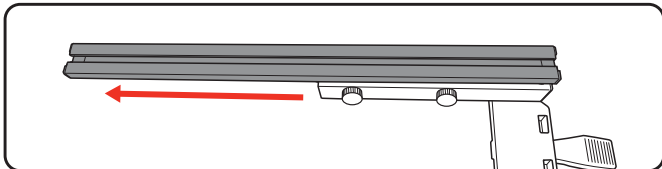

Note: As a rule of thumb, the rear end of the stop comes up against an imaginary line that begins roughly at the centre of the blade and runs at an angle of 45° to the rear.

1. Set the required cutting width.
2. Loosen the 2 fence screws and push the stop rail forward until it touches the imaginary 45° line.
3. Retighten the 2 fence screws.

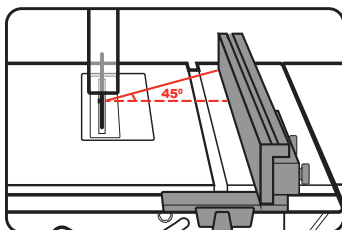

Rip Fence Cutting Width

The rip fence has to be used when making longitudinal cuts in wooden work pieces.

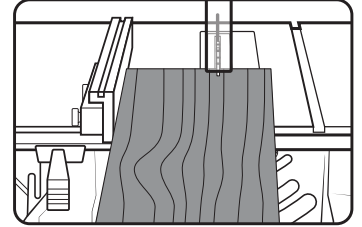

The rip fence can be mounted on either side of the saw table but may require you to change the orientation of the guide rail.

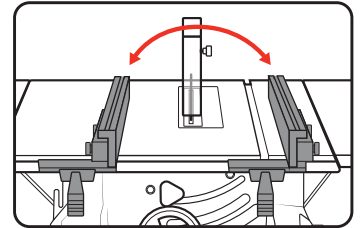

1. Loosen the rip fence lever and insert the fence onto the table guide rail.

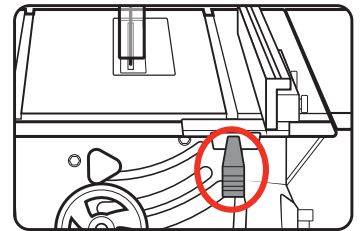

2. Slide the rip fence to the desired dimension using the scale on the guide rail.

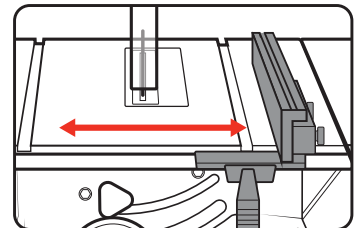

3. Tighten the rip fence lever to lock the rip fence in position.

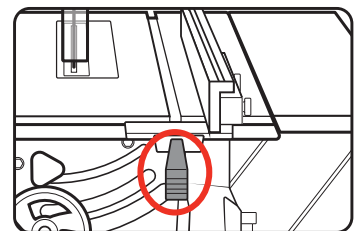

OPERATION

3. SETTING THE MITRE GAUGE

Using the Sliding Mitre Gauge

The sliding mitre gauge can be fitted into 1 of the 2 grooves in the table and can be used to easily perform mitre angle cuts.

1. Slide the rail of the mitre gauge into 1 of the grooves of the table.

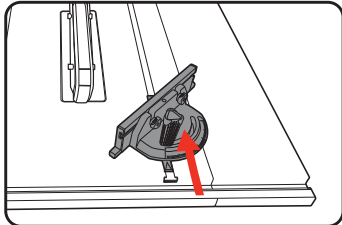

2. Loosen the screw to adjust the mitre angle.

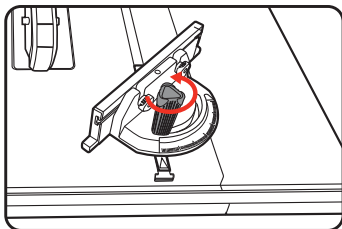

3. Rotate the mitre gauge to the desired angle using the mitre scale.

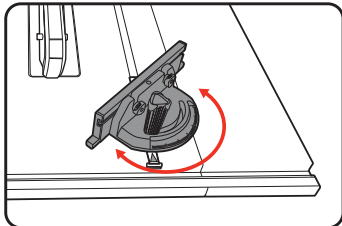

4. Lock the mitre angle by tightening the screw.

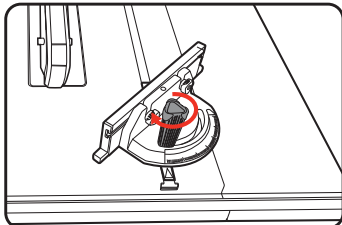

WARNING! DO NOT PUSH THE MITRE GAUGE STOP RAIL TOO FAR TOWARD THE BLADE. THE DISTANCE BETWEEN THE STOP RAIL AND THE BLADE SHOULD BE APPROXIMATELY 20MM.

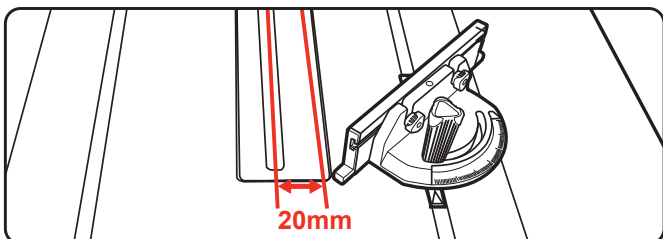

4. USING THE TABLE SAW

WARNING! TO REDUCE THE RISK OF ELECTRICAL SHOCK, THE USE OF A RESIDUAL CURRENT DEVICE (RATED 30mA OR LESS) IS RECOMMENDED.

On / Off Switch

1. To turn the saw on, press the green button "I".

Note: Wait for the blade to reach its maximum speed before commencing with the cut.

2. To turn the saw off, press the red button "O".

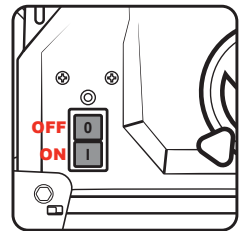

Safety Overload Cut-Off

The table saw will automatically stop if the machine is overloaded and triggers the safety cut-off mechanism. The overload switch will pop out if this happens. Follow the steps below to reset the table saw.

1. Turn the power off by pressing the red "O" button to prevent the saw from starting up before you intend.

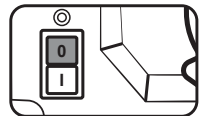

2. Unplug the power cord and allow the machine to cool down for 5 minutes and investigate the cause of the overload. If the workpiece has jammed, remove it while the saw is off and unplugged.

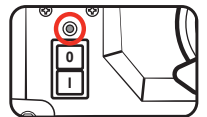

3. Press the reset button on the top of the red "O" button.

WARNING! WEAR GLOVES WHEN HANDLING THE BLADE AS IT IS VERY SHARP AND HOT AFTER CUTTING OPERATION.

4. Once the table saw has cooled off you may resume use as normal.

WARNING! IF THE TABLE SAW CUTS-OFF AGAIN IMMEDIATELY AFTER A RESET, DO NOT CONTINUE TO USE THE TOOL & CONTACT CUSTOMER SERVICE.

Blade Guard

1. The blade guard must be able to move freely, adjust if necessary (refer to Assembly Manual).
2. Make sure the saw blade is not contacting the guard, riving knife or the workpiece before the switch is turned on.

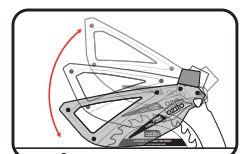

WARNING! THE BLADE GUARD MUST ALWAYS BE LOWERED OVER THE WORK PIECE AND MOUNTED SECURELY BEFORE YOU BEGIN TO CUT.

WARNING! NEVER USE THE TABLE SAW WITHOUT THE BLADE GUARD IN PLACE.

5. MAKING A CUT

Making Longitudinal Cuts / Ripping

Press one edge of the workpiece against the rip fence while the flat side lies on the saw table. The blade guard must always be lowered over the workpiece.

When you make a longitudinal cut, never adopt a working position that is in line with the cutting direction.

1. Set the rip fence in accordance with the workpiece height and the desired width. (See **Rip Fence Stop Height, Cutting Width**).
2. Switch on the saw by pressing the on button "I".

3. Place your hands (with fingers closed ensuring they will be clear of the blade) flat on the workpiece and push the workpiece along the rip fence and into the blade.

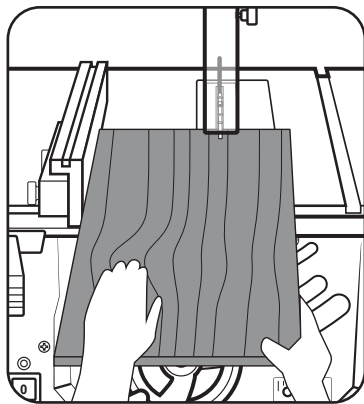

4. Guide at the side with your left or right hand (depending on the position of the rip fence) only as far as the front edge of the table.

5. Always push the workpiece through to the end of the riving knife.

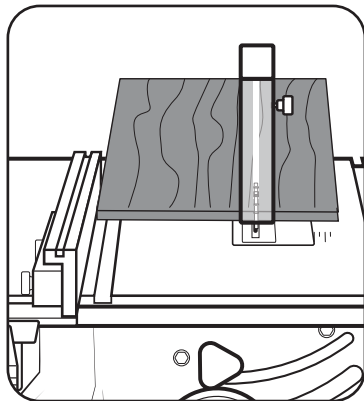

6. The off cut piece remains on the saw table until the blade is back in its position of rest.

7. Secure long work pieces against falling off at the end of the cut (e.g. with a roller stand etc.) .

WARNING! KEEP HANDS WELL CLEAR OF THE BLADE AT ALL TIMES. IT IS RECOMMENDED TO USE THE PUSH STICK EVEN IF CUTTING WIDE MATERIAL.

Dust Extraction

A 35mm vacuum hose and vacuum can be attached to the extraction port on the rear for dust extraction during use.

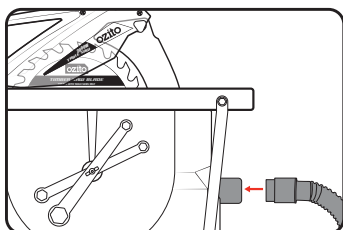

Cutting Narrow Work Pieces

WARNING! BE SURE TO USE A PUSH STICK WHEN MAKING LONGITUDINAL CUTS.

Be sure to use a push stick when making longitudinal cuts in work pieces smaller than 120mm in width. A push stick is supplied with the saw.

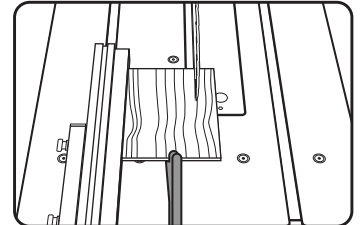

Replace a worn or damaged push stick immediately.

Making Bevel Cuts

Bevel cuts must always be done using the rip fence.

1. Set the blade to the desired angle. (See **Setting the Bevel Angle**)
2. Set the rip fence in accordance with the workpiece width and height (see **Rip Fence Stop Height**)
3. Carry out the cut in accordance with the workpiece width.

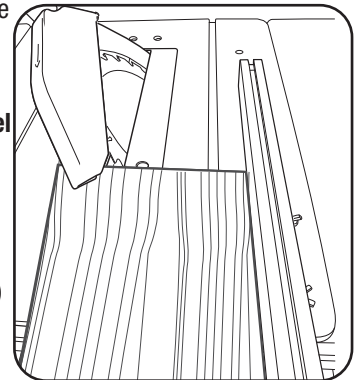

Making Cross Cuts

1. Slide the sliding mitre gauge into one of the grooves in the table and adjust to the required angle (see **Sliding Mitre Gauge**).

WARNING! DO NOT PUSH THE MITRE GAUGE STOP RAIL TOO FAR TOWARD THE BLADE. THE DISTANCE BETWEEN THE STOP RAIL AND THE BLADE SHOULD BE APPROXIMATELY 20MM.

2. Press the workpiece firmly against the sliding mitre gauge.
3. Switch on the saw by pressing the on button "I".

4. Push the sliding mitre gauge and the workpiece toward the blade in order to make the cut.

5. Push the sliding mitre gauge forward until the workpiece is cut all the way through.

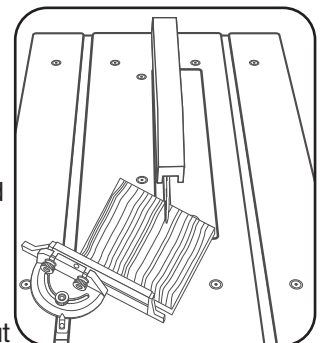

6. Switch off the saw again. Do not remove the off-cut until the blade has stopped rotating.

MAINTENANCE

WARNING! BEFORE CLEANING THE APPLIANCE OR CARRYING OUT ANY MAINTENANCE PROCEDURE, MAKE SURE THAT IT IS DISCONNECTED FROM THE POWER SUPPLY TO PREVENT ACCIDENTAL STARTING.

Fitting / Replacing the Blade

This product is designed for **Ø254mm (Diameter) x Ø30mm (Bore)** saw blades for timber cutting only.

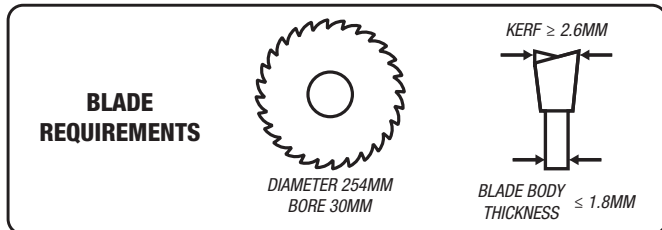

WARNING! ENSURE THAT THE SAW BLADE IS SUITABLE FOR THE MATERIAL TO BE CUT AND THAT THE MAXIMUM POSSIBLE SPEED IS MORE THAN THE MAXIMUM TOOL SPEED.

1. Set the blade to the max cutting depth by rotating the adjustment wheel and setting the bevel adjustment to 0°.

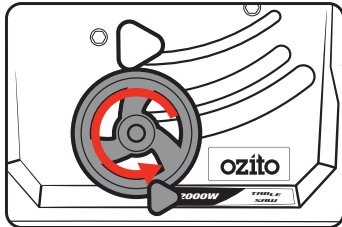

2. Remove the blade guard by undoing the screw.

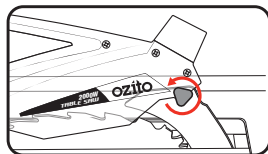

2. Unscrew the Philips head screw and remove the table insert.

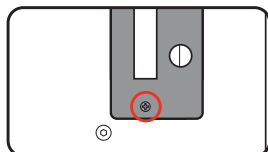

3. Undo the blade bolt with the 13mm and 21mm spanner on the blade outer flange to apply counter-pressure. Keep fingers and hands away from blade. Wear leather gloves

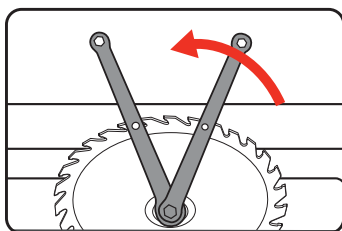

WARNING! TURN THE BLADE BOLT IN THE DIRECTION OF ROTATION OF THE SAW BLADE.

4. Take off the outer flange and pull the old saw blade off the inner flange by dropping the blade at an angle.

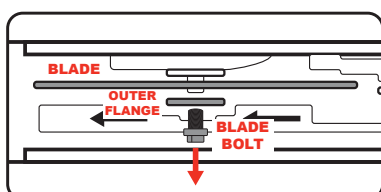

Note: Ensure that the inner flange is attached to the motor shaft.

5. Clean the blade flange thoroughly before fitting the new blade.

6. Mount and fasten the new saw blade following the previous steps reverse order. Ensure the blade direction matches the arrow direction indicated on the housing.

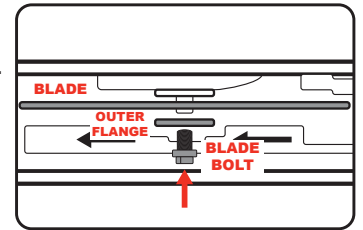

7. Refit and set the riving knife, table insert and blade guard.

8. Check to make sure that all safety devices are properly mounted and in good working condition before you begin working with the saw again.

WARNING! NOTE THE RUNNING DIRECTION. THE CUTTING ANGLE OF THE TEETH MUST POINT IN THE RUNNING DIRECTION, IE. FORWARDS (REFER TO THE ARROW ON THE BLADE GUARD).

Setting the Riving Knife

The riving knife helps to prevent kickback and should be checked each time the blade is replaced.

1. Set the blade to the max cutting depth by rotating the adjustment wheel and setting the bevel adjustment to 0°.

2. Unscrew the Philips head screw and remove the table insert.

3. Loosen the riving knife plate screw with the 13mm spanner.

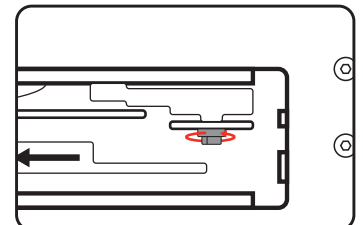

4. Raise the riving knife until the clearance between the blade and the riving knife is 3-5mm.

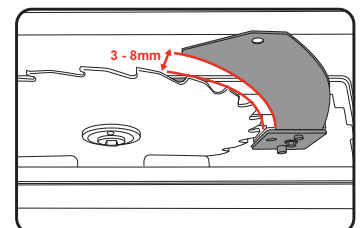

5. Retighten the plate screw.

6. Refit the table insert by sliding the plastic tab on the back end under the lip of the blade cavity and lowering it over the blade. Redo the Philips head screw. The table insert should be flush with the surface of the table saw.

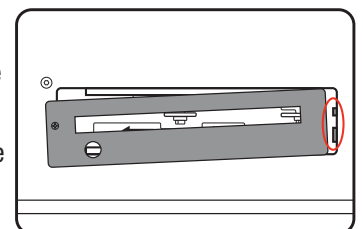

WARNING! NEVER USE THE TABLE SAW WITHOUT THE TABLE INSERT FITTED.

DESCRIPTION OF SYMBOLS

Changing the Table Insert

To prevent increased likelihood of injury the table insert should be changed whenever it is worn or damaged.

1. Remove the Philips head screw on the table insert.
2. Take out the worn table insert.

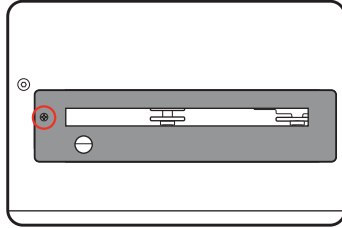

3. To fit the replacement table insert, proceed in reverse order.

Riving Knife

- The saw blade must be no more than 254mm in diameter.
- The riving knife is 2.2mm thick.
- The cutting direction of the teeth (direction of the arrow on the saw blade) must match the direction of the arrow on the riving knife.
- When changing the saw blade, make sure that the kerf is larger than 2.6mm and the blade body thickness is less than 1.8mm. Otherwise there is a risk that the riving knife will hook into the workpiece.

Cleaning

1. We recommend that you clean the appliance immediately after you use it.
2. Keep the safety devices free of dirt and dust as much as possible. Wipe the equipment with a clean cloth.
3. Clean the appliance regularly with a damp cloth and some soft soap. Do not use cleaning agents or solvents; these may be aggressive to the plastic parts in the appliance. Ensure that no water can get into the interior of the appliance.

Storage

Pull the mains plug out of the socket, switch off the tool and make sure that it is secured in such a way that it cannot be started up again by any unauthorised person.

Store the tool in a dry location which is not accessible to unauthorised persons.

Supply Cords

If replacement of the supply cord is necessary, this has to be done by a certified electrician in order to avoid a safety hazard.

Note: Ozito Industries will not be responsible for any damage or injuries caused by the repair of the tool by an unauthorised person or by mishandling of the tool.

DESCRIPTION OF SYMBOLS

V	Volts	Hz	Hertz
~	Alternating Current	W	Watts
/min	Revolutions or reciprocations per minute	n₀	No load speed
	Wear eye, ear & breathing protection		Wear hearing protection
	Wear breathing protection		Wear eye protection
	Double insulated		Warning
	Wear gloves		Regulatory Compliance Mark (RCM)
	Read Instruction Manual		Danger! Sharp blade

ADDITIONAL INFORMATION

Operating mode S6 40%: Continuous operation with idling (cycle time 10 minutes). To ensure that the motor does not become excessively hot it may only be operated for 40% of the cycle at the specified rating and must then be allowed to idle for 60% of the cycle.

CARING FOR THE ENVIRONMENT

Power tools that are no longer usable should not be disposed of with household waste but in an environmentally friendly way. Please recycle where facilities exist. Check with your local council authority for recycling advice.

Recycling packaging reduces the need for landfill and raw materials. Reuse of recycled material decreases pollution in the environment. Please recycle packaging where facilities exist. Check with your local council authority for recycling advice.

SPARE PARTS

Spare parts can be ordered from the Special Orders Desk at your local Bunnings Warehouse.

For further information, or any parts not listed here, visit

www.ozito.com.au or contact Ozito Customer Service:

Australia 1800 069 486

New Zealand 0508 069 486

E-mail: enquiries@ozito.com.au

ELECTRICAL SAFETY



WARNING! When using mains-powered tools, basic safety precautions, including the following, should always be followed to reduce risk of fire, electric shock, personal injury and material damage.
Read the whole manual carefully and make sure you know how to switch the tool off in an emergency, before operating the tool.

Save these instructions and other documents supplied with this tool for future reference.

This tool has been designed for 230V and 240V only. Always check that the power supply corresponds to the voltage on the rating plate.

Note: The supply of 230V and 240V on Ozito tools are interchangeable for Australia and New Zealand.

This tool is double insulated; therefore no earth wire is required.



Note: Double insulation does not take the place of normal safety precautions when operating this tool. The insulation system is for added protection against injury resulting from a possible electrical insulation failure within the tool.

Using an Extension Lead

Always use an approved extension lead suitable for the power input of this tool. Before use, inspect the extension lead for signs of damage, wear and ageing. Replace the extension lead if damaged or defective.

When using an extension lead on a reel, always unwind the lead completely. Use of an extension lead not suitable for the power input of the tool or which is damaged or defective may result in a risk of fire and electric shock.

The power supply for this product should be protected by a residual current device (rated at 30mA or less). A residual current device reduces the risk of electric shock.

GENERAL POWER TOOL SAFETY WARNINGS



WARNING! Read all safety warnings, instructions, illustrations and specifications provided with this power tool. Failure to follow all instructions listed below may result in electric shock, fire and/or serious injury.

Save all warnings and instructions for future reference.

The term "power tool" in the warnings refers to your mains-operated (corded) power tool or battery-operated (cordless) power tool.

1) Work area safety

- Keep work area clean and well lit.** Cluttered or dark areas invite accidents.
- Do not operate power tools in explosive atmospheres, such as in the presence of flammable liquids, gases or dust.** Power tools create sparks which may ignite the dust or fumes.
- Keep children and bystanders away while operating a power tool.** Distractions can cause you to lose control.

2) Electrical safety

- Power tool plugs must match the outlet. Never modify the plug in any way. Do not use any adapter plugs with earthed (grounded) power tools.** Unmodified plugs and matching outlets will reduce risk of electric shock.
- Avoid body contact with earthed or grounded surfaces, such as pipes, radiators, ranges and refrigerators.** There is an increased risk of electric shock if your body is earthed or grounded.
- Do not expose power tools to rain or wet conditions.** Water entering a power tool will increase the risk of electric shock.
- Do not abuse the cord. Never use the cord for carrying, pulling or unplugging the power tool. Keep cord away from heat, oil, sharp edges or moving parts.** Damaged or entangled cords increase the risk of electric shock.
- When operating a power tool outdoors, use an extension cord suitable for outdoor use.** Use of a cord suitable for outdoor use reduces the risk of electric shock.
- If operating a power tool in a damp location is unavoidable, use a residual current device (RCD) protected supply.** Use of an RCD reduces the risk of electric shock.

3) Personal safety

- Stay alert, watch what you are doing and use common sense when operating a power tool. Do not use a power tool while you are tired or under the influence of drugs, alcohol or medication.** A moment of inattention while operating power tools may result in serious personal injury.
- Use personal protective equipment. Always wear eye protection.** Protective equipment such as a dust mask, non-skid safety shoes, hard hat or hearing protection used for appropriate conditions will reduce personal injuries.
- Prevent unintentional starting. Ensure the switch is in the off-position before connecting to power source and/or battery pack, picking up or carrying the tool.** Carrying power tools with your finger on the switch or energising power tools that have the switch on invites accidents.
- Remove any adjusting key or wrench before turning the power tool on.** A wrench or a key left attached to a rotating part of the

power tool may result in personal injury.

- Do not overreach. Keep proper footing and balance at all times.** This enables better control of the power tool in unexpected situations.
 - Dress properly. Do not wear loose clothing or jewellery. Keep your hair and clothing away from moving parts.** Loose clothes, jewellery or long hair can be caught in moving parts.
 - If devices are provided for the connection of dust extraction and collection facilities, ensure these are connected and properly used.** Use of dust collection can reduce dust-related hazards.
 - Do not let familiarity gained from frequent use of tools allow you to become complacent and ignore tool safety principles.** A careless action can cause severe injury within a fraction of a second.
- ### 4) Power tool use and care
- Do not force the power tool. Use the correct power tool for your application.** The correct power tool will do the job better and safer at the rate for which it was designed.
 - Do not use the power tool if the switch does not turn it on and off.** Any power tool that cannot be controlled with the switch is dangerous and must be repaired.
 - Disconnect the plug from the power source and/or remove the battery pack, if detachable, from the power tool before making any adjustments, changing accessories, or storing power tools.** Such preventive safety measures reduce the risk of starting the power tool accidentally.
 - Store idle power tools out of the reach of children and do not allow persons unfamiliar with the power tool or these instructions to operate the power tool.** Power tools are dangerous in the hands of untrained users.
 - Maintain power tools and accessories. Check for misalignment or binding of moving parts, breakage of parts and any other condition that may affect the power tool's operation. If damaged, have the power tool repaired before use.** Many accidents are caused by poorly maintained power tools.
 - Keep cutting tools sharp and clean.** Properly maintained cutting tools with sharp cutting edges are less likely to bind and are easier to control.
 - Use the power tool, accessories and tool bits etc. in accordance with these instructions, taking into account the working conditions and the work to be performed.** Use of the power tool for operations different from those intended could result in a hazardous situation.
 - Keep handles and grasping surfaces dry, clean and free from oil and grease.** Slippery handles and grasping surfaces do not allow for safe handling and control of the tool in unexpected situations.

5) Service

- Have your power tool serviced by a qualified repair person using only identical replacement parts.** This will ensure that the safety of the power tool is maintained.

TABLE SAW SAFETY WARNINGS



WARNING! The appliance is not to be used by persons (including children) with reduced physical, sensory or mental capabilities, or lack of experience and knowledge, unless they have been given supervision or instruction. Young children should be supervised to ensure that they do not play with the appliance. Before connecting a tool to a power source (mains switch power point receptacle, outlet, etc.) be sure that the voltage supply is the same as that specified on the nameplate of the tool. A power source with a voltage greater than that specified for the tool can result in serious injury to the user, as well as damage to the tool. If in doubt, do not plug in the tool. Using a power source with a voltage less than the nameplate rating is harmful to the motor.

- This tool is designed to cut timber products only. Do not use the tool to cut any other materials. Do not cut firewood with this tool. The irregular shape of firewood makes it unsafe to cut with this tool.
- Blade depth and bevel adjusting locking levers must be tight and secure before making a cut. If blade adjustment shifts while cutting, it may cause binding and kickback. Ensure all clamps, levers and locking knobs are securely tightened prior to operation. This will result in projects being produced accurately and safely.
- When the blade binds in material being cut, switch off the tool and wait for blade to come to a complete stop. Investigate and take corrective action to eliminate cause of binding.
- Do not use the saw to perform rebate or groove cuts unless suitable guarding, such as tunnel guard, is fitted above the saw table. Do not use the saw for slotting (stopped groove) cuts.
- Use only transportation devices and never use the cuttings guards for handling or transportation when transporting the machine. Always ensure the blades are covered by the blade guard during transportation.

Guarding related warnings

- Keep guards in place. Guards must be in working order and be properly mounted. A guard that is loose, damaged, or is not functioning correctly must be repaired or replaced.
- Always use saw blade guard and riving knife for every through-cutting operation. For through-cutting operations where the saw blade cuts completely through the thickness of the workpiece, the guard and other safety devices help reduce the risk of injury.
- Make sure the saw blade is not contacting the guard, riving knife or the workpiece before the switch is turned on. Inadvertent contact of these items with the saw blade could cause a hazardous condition.
- Adjust the riving knife as described in this instruction manual. Incorrect spacing, positioning and alignment can make the riving knife ineffective in reducing the likelihood of kickback.
- For the riving knife device to work, it must be engaged in the workpiece. The riving knife is ineffective when cutting workpieces that are too short to be engaged with the riving knife. Under these conditions a kickback cannot be prevented by the riving knife.
- Use the appropriate saw blade for the riving knife. For the riving knife to function properly, the saw blade diameter must match the appropriate riving knife and the body of the saw blade must be thinner than the thickness of the riving knife and the cutting width of the saw blade must be wider than the thickness of the riving knife.

Cutting procedures warnings

- Danger:** Never place your fingers or hands in the vicinity or in line with the saw blade. A moment of inattention or a slip could direct your hand towards the saw blade and result in serious personal injury
- Feed the workpiece into the saw blade only against the direction of rotation. Feeding the workpiece in the same direction that the saw blade is rotating above the table may result in the workpiece, and your hand, being pulled into the saw blade.
- Never use the mitre gauge to feed the workpiece when ripping and do not use the rip fence as a length stop when cross cutting with the mitre gauge. Guiding the workpiece with the rip fence and the mitre gauge at the same time increases the likelihood of saw blade binding and kickback.
- When ripping, always apply the workpiece feeding force between the fence and the saw blade. Use a push stick when the distance between the fence and the saw blade is less than 150mm, and use a push block when this distance is less than 50mm. "Work helping" devices will keep your hand at a safe distance from the saw blade.
- Use only the push stick provided by the manufacturer or constructed in accordance with the instructions. This push stick provides sufficient distance of the hand from the saw blade.
- Never use a damaged or cut push stick. A damaged push stick may break causing your hand to slip into the saw blade.
- Do not perform any operation "freehand". Always use either the rip fence or the mitre gauge to position and guide the workpiece. "Freehand" means using your hands to support or guide the workpiece, in lieu of a rip fence or mitre gauge. Freehand sawing leads to misalignment, binding and kickback.
- Never reach around or over a rotating saw blade. Reaching for a workpiece may lead to accidental contact with the moving saw blade.
- Provide auxiliary workpiece support to the rear and/or sides of the saw table for long and/or wide workpieces to keep them level. A long and/or wide workpiece has a tendency to pivot on the table's edge, causing loss of control, saw blade binding and kickback.
- Feed workpiece at an even pace. Do not bend or twist the workpiece. If jamming occurs, turn the tool off immediately,

unplug the tool then clear the jam. Jamming the saw blade by the workpiece can cause kickback or stall the motor.

- Do not remove pieces of cut-off material while the saw is running. The material may become trapped between the fence or inside the saw blade guard and the saw blade pulling your fingers into the saw blade. Turn the saw off and wait until the saw blade stops before removing material.
- Use an auxiliary fence in contact with the table top when ripping workpieces less than 2mm thick. A thin workpiece may wedge under the rip fence and create a kickback.

Kickback causes and related warnings

Kickback is a sudden reaction of the workpiece due to a pinched, jammed saw blade or misaligned line of cut in the workpiece with respect to the saw blade or when a part of the workpiece binds between the saw blade and the rip fence or other fixed object. Most frequently during kickback, the workpiece is lifted from the table by the rear portion of the saw blade and is propelled towards the operator. Kickback is the result of saw misuse and/or incorrect operating procedures or conditions and can be avoided by taking proper precautions as given below.

- Never stand directly in line with the saw blade. Always position your body on the same side of the saw blade as the fence. Kickback may propel the workpiece at high velocity towards anyone standing in front and in line with the saw blade.
- Never reach over or in back of the saw blade to pull or to support the workpiece. Accidental contact with the saw blade may occur or kickback may drag your fingers into the saw blade.
- Never hold and press the workpiece that is being cut off against the rotating saw blade. Pressing the workpiece being cut off against the saw blade will create a binding condition and kickback.
- Align the fence to be parallel with the saw blade. A misaligned fence will pinch the workpiece against the saw blade and create kickback.
- Use a featherboard to guide the workpiece against the table and fence when making non-through cuts such as rebating or resawing cuts. A featherboard helps to control the workpiece in the event of a kickback.
- Support large panels to minimise the risk of saw blade pinching and kickback. Large panels tend to sag under their own weight. Support(s) must be placed under all portions of the panel overhanging the table top.
- Use extra caution when cutting a workpiece that is twisted, knotted, warped or does not have a straight edge to guide it with a mitre gauge or along the fence. A warped, knotted, or twisted workpiece is unstable and causes misalignment of the kerf with the saw blade, binding and kickback.
- Never cut more than one workpiece, stacked vertically or horizontally. The saw blade could pick up one or more pieces and cause kickback.
- When restarting the saw with the saw blade in the workpiece, centre the saw blade in the kerf so that the saw teeth are not engaged in the material. If the saw blade binds, it may lift up the workpiece and cause kickback when the saw is restarted.
- Keep saw blades clean, sharp, and with sufficient set. Never use warped saw blades or saw blades with cracked or broken teeth. Sharp and properly set saw blades minimise binding, stalling and kickback.

Table saw operating procedure warnings

- Turn off the table saw and disconnect the power cord when removing the table insert, changing the saw blade or making adjustments to the riving knife or saw blade guard, and when the machine is left unattended. Precautionary measures will avoid accidents.
- Never leave the table saw running unattended. Turn it off and don't leave the product until it comes to a complete stop. An unattended running saw is an uncontrolled hazard.
- Locate the table saw in a well-lit and level area where you can maintain good footing and balance. It should be installed in an area that provides enough room to easily handle the size of your workpiece. Cramped, dark areas, and uneven slippery floors invite accidents.
- Frequently clean and remove sawdust from under the saw table and/or the dust collection device. Accumulated sawdust is combustible and may self-ignite.
- The table saw must be secured. A table saw that is not properly secured may move or tip over.
- Remove tools, wood scraps, etc. from the table before the table saw is turned on. Distraction or a potential jam can be dangerous.
- Always use saw blades with correct size and shape (diamond versus round) of arbour holes. Saw blades that do not match the mounting hardware of the saw will run off-centre, causing loss of control.
- Never use damaged or incorrect saw blade mounting means such as flanges, saw blade washers, bolts or nuts. These mounting means were specially designed for your saw, for safe operation and optimum performance.
- Never stand on the table saw, do not use it as a stepping stool. Serious injury could occur if the product is tipped or if the cutting tool is accidentally contacted.
- Make sure that the saw blade is installed to rotate in the proper direction. Do not use grinding wheels, wire brushes, or abrasive wheels on a table saw. Improper saw blade installation or use of accessories not recommended may cause serious injury.