

step 3

Now follow the instructions to fit your doors and panels.

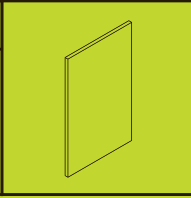

attaching door

Things you need to know

- Make sure you leave plumbing and electrical work to qualified trades people. Never try this yourself.
- All holes that aren't already pre-drilled should be drilled prior to screwing using a No 12 countersinking drill bit.
- Make sure you always use safety gear like a mask, ear muffs and glasses when using tools.
- **Gloss vinyl doors & panels are protected with a top clear wrap that needs to be removed. Depending on application of the panel, this may need to be removed prior to installation.**
- If you have any questions, contact us on:
Australia: **1800 666 078** Monday to Friday between 8:00am and 6:00pm AEST, New Zealand: **0800 522 663** Monday to Friday between 8:00am and 5:00pm NZST or email: info@kaboodlegroup.com.au .

Hardware needed



Tools you will need

To put your kaboodle kitchen cabinets together you will need the following tools.

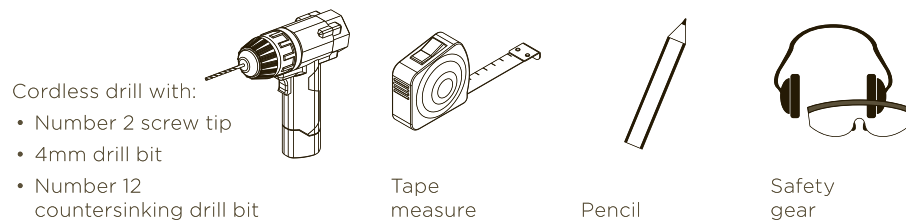



attaching door & drawer panels

attaching door to cabinet

1.

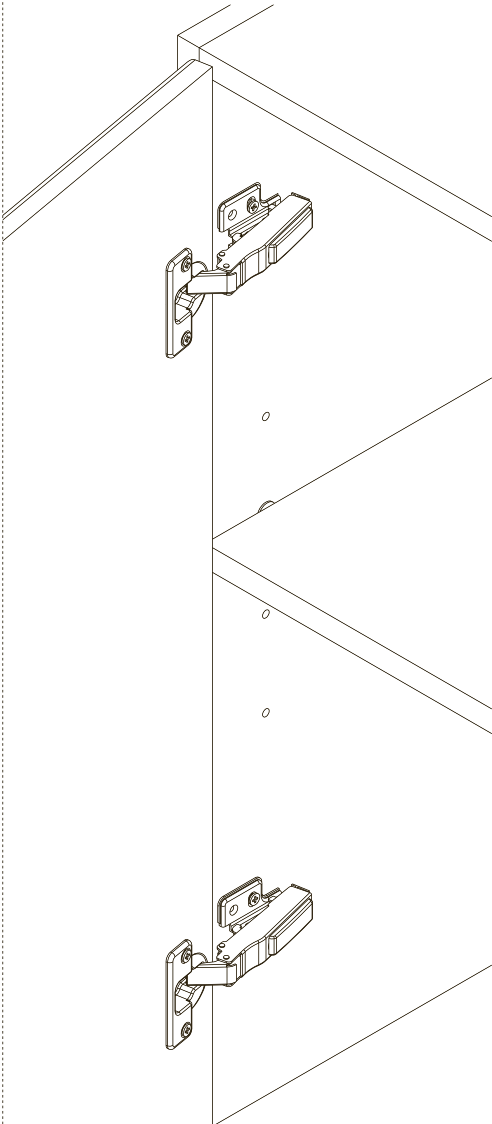

adjusting door

1.

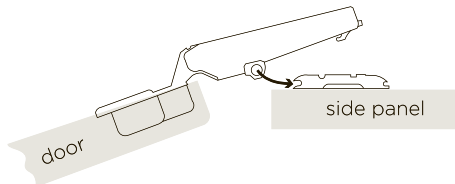

a. Clip the door onto the hinge plates.

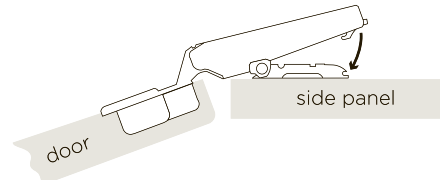

b. Now push down to clip hinge securely together.

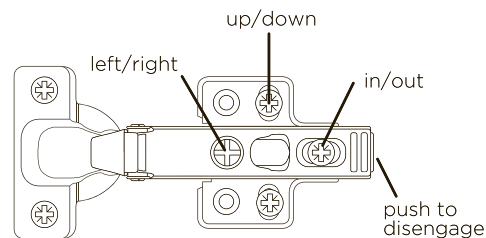

c. To align doors adjust marked screws.

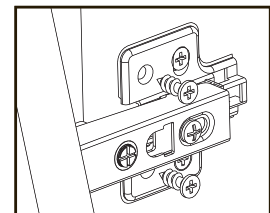

tip. add extra screws once door is aligned.

Caring for your kaboodle doors and panels

Looking after your cabinets is really easy and with the right care and maintenance they will last you for many years. Just follow these simple steps and if you need any more information you can contact us us: Australia: **1800 666 078** Monday to Friday between 8:00am and 6:00pm AEST. New Zealand: **0800 522 663** Monday to Friday between 8:00am and 5:00pm NZST or email: info@kaboodlegroup.com.au.

All doors should be cleaned with warm soapy water or an all purpose, non-abrasive cleaner with a damp cloth and make sure you never use a saturated cloth, harsh chemicals or thinner based cleaners. Try to avoid using sponges on your doors and these can leave residue streaks on the surface. Never use steel wool, scourers, dry cloths or rough products on any doors as this will scratch the surface.

Handy hint: Most stains will wipe off if attended to straight away, but for more stubborn stains you can use an undiluted, commercial non-abrasive cleaner and soak for a few seconds and then clean with warm soapy water. Just make sure you test the cleaning product on an unexposed section of the surface first to ensure it won't damage the finish. If a door or panel is gouged, chipped or scratched, you can try and use a matching coloured texta to rub into the area...or just buy a new door!

We offer a dedicated customer service line for advice or any questions you may have on kaboodle products.

Call customer service on:
Australia: **1800 666 078** Monday to Friday between 8.00am and 6.00pm AEST

New Zealand: **0800 522 663** Monday to Friday between 8.00am and 5.00pm NZST or email: info@kaboodlegroup.com.au

step 1 ✓	Your Kaboodle cabinet is now complete.
step 4	Finish off your Kaboodle Kitchen by installing your benchtop.
step 2 ✓	You've finished adding your parts and accessories.
step 3 ✓	You've added your doors and panels.