



Complete fencing solutions



Bunnings Trade offers a wide range of fencing products for all types of projects, from residential to commercial. We can supply the trade quality brands and stock quantities that you need, delivering straight to your site to make managing your jobs as easy as possible.

INTRODUCTION

- Bunnings offers a wide range of fencing products for all types of projects, from residential to commercial.
- Many ranges can be customised to suit your customers' size and colour preferences.
- Talk to us about how we can help you deliver a premium quality finish, no matter the type or scale of job you're working on.
- It's all about convenience and saving time: place an order and we'll have the materials ready for collection from a Bunnings store or delivered directly to your site.

CONTENTS

- 3 [POOL FENCING](#)
- 7 [BALUSTRADING](#)
- 10 [BOUNDARY FENCING](#)
- 19 [SECURITY FENCING](#)
- 25 [GATES](#)
- 28 [TEMPORARY FENCING](#)



GLASS POOL FENCING



This glass pool fencing system includes gate and hinge panels that are custom-made to fit **The Architects Choice** hinges and latches, which makes alignment and gate-fitting quick and easy.

It can be installed with spigots to provide a superior quality, frameless glass pool fence. Alternatively, install with posts for a semi-frameless glass pool fence that provides a premium look on a budget.

A wide range of accessories is also available to complete your fencing, including:

- Friction-fit handrails finished in Mirror Polished Stainless Steel or Matt Black Aluminium;
- Clamps finished in Mirror Polished or Matt Black (rectangular or oval);
- 2.4m long handrails powder-coated in Satin Black or Palladium Silver
- Joiners;
- Wall mounts; and
- Endcaps.

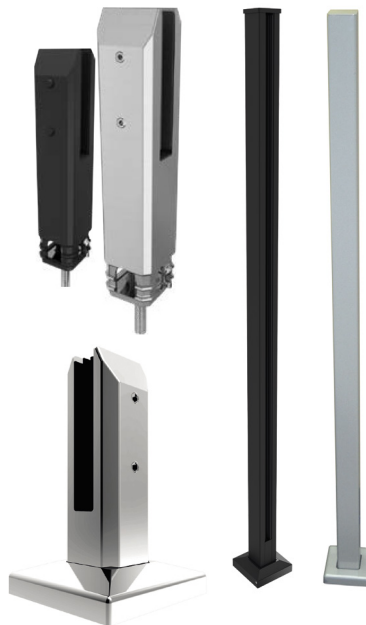

SPECS

- Premium Automotive Grade Toughened Glass
- Available in widths from 500-1300mm
- Conforms to AS 1926.1-2007/2012, NZS 8500-2006, AS/NZS 2208-1996

Available instore or to order
 Speak to the Trade Specialist at your local warehouse or the team at your nearest Trade Centre.



**DESIGN
 TOOLS
 AVAILABLE**





ALUMINIUM POOL FENCING

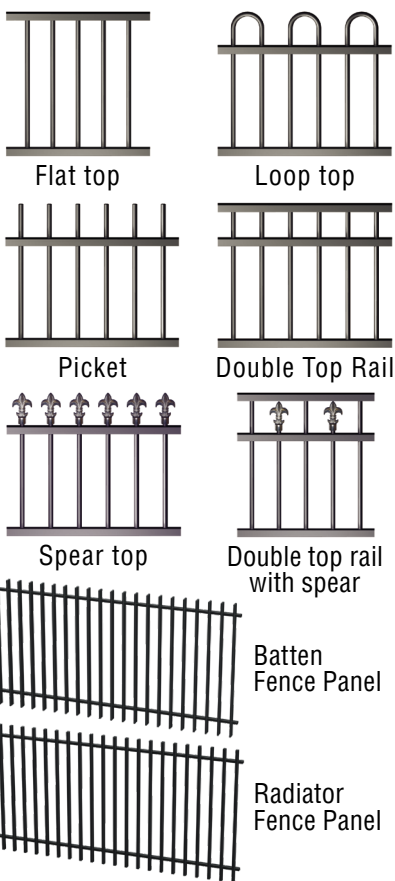

Protector Aluminium pool panels and gates have been tested to meet Australian Standards. They are designed for superior strength, easy installation and maximum safety, and include the Ulti-M8 ultra-strength core system. This system features additional inner ribs within all pickets, along with top and bottom rails. In addition to core strength, six-point welds are applied, making **Protector Aluminium** pool panels and gates extremely strong and secure.

This product can be custom ordered in a wide variety of sizes, styles or colours to meet your customer's needs. Raked panels are also available to allow for sloping ground.

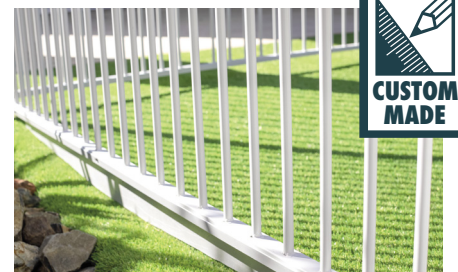

SPECS

- Wide variety of colours available
- Designed and manufactured to exceed AS/NZS1926.1
- Includes the Ulti-M8, ultra-strength core system
- Standard panels 1200mm H x 2450mm W
- Standard gates 1200mm H x 975mm W

Available instore or to order
 Speak to the Trade Specialist at your local warehouse or the team at your nearest Trade Centre.





STEEL POOL FENCING



Sturt™ steel panels and gates are manufactured for the budget-conscious customer, designed to withstand Australia's harsh conditions. Panels are manufactured and powder-coated locally with Dulux® Duralloy® premium powder-coating, featuring advanced durable polyester thermosetting powder that meets Australian Standard AS3715.

These standardised panels and single gates are prefabricated, lightweight and easy to install, coming in a black powder-coated finish. There is also a wide variety of colours from the Dulux® Duralloy® powder-coat range to allow you to tailor the product to meet your customer's needs.

Panels and gates come supplied with all the brackets and fixings required for installation.



SPECS

- Wide variety of colours available
- Made in Australia from 70% recycled steel
- Conforms to Australian Standards AS 1926.1 for pool fencing
- Available in heights from 900-1800mm and widths of 2400mm or 3000mm
- Compliance certificates can be provided

Available to order
Speak to the Trade Specialist at your local warehouse or the team at your nearest Trade Centre.





STEEL POOL FENCING

RAPIDFENCE™

These picket top fence panels are pool-compliant and offer a sleek, contemporary style to complement your pool and outdoor area. They are made from steel to provide excellent strength and durability. They are also impact-resistant, low-maintenance and will withstand Australia's harsh conditions.



SPECS

- Available in dark grey only
- Panels available in 1200mm or 1500mm heights
- Conforms to Australian Standards AS 1926.1 for pool fencing
- Pool latch and hinges sold separately
- Pre Galvanised Steel, Zinc rich Primer and Powder coated

Available instore or to order
Speak to the Trade Specialist at your local warehouse or the team at your nearest Trade Centre.



**DESIGN
TOOLS
AVAILABLE**





GLASS BALUSTRADING



THE ARCHITECTS CHOICE

Made from premium automotive grade heat-soaked glass that is specifically designed for balustrade, this range has quality fittings and fixtures with a choice of systems and finishes. With rounded safety edges, this product is suitable for residential applications where the fall is less than 4m to ground level. Install with spigots to provide a clear view with clean lines, or install with posts to provide a cost-effective, semi frameless balustrade that provides a premium look on a budget.

A wide range of accessories are also available to complete your fencing, including:

- Friction-fit handrails finished in Mirror Polished Stainless Steel or Matt Black Aluminium;
- Offset handrails in Palladium Silver or Satin Black;
- Clamps finished in Mirror Polished or Matt Black (rectangular or oval);
- 2.4m long handrails powder-coated in Satin Black or Palladium Silver;
- Joiners;
- Wall mounts; and
- Endcaps.



SPECS

- Conforms to AS/NZS 2208:1996.

Available instore or to order

Speak to the Trade Specialist at your local warehouse or the team at your nearest Trade Centre.



**DESIGN
TOOLS
AVAILABLE**



**BUNNINGS
TRADE**

Helping business is our trade.



ALUMINIUM BALUSTRADING



Peak® Aluminium Balustrade is made from powder-coated aluminium for low-maintenance durability, with no sanding or staining required. Engineered to meet building code requirements*, it will not rot or rust, even in coastal environments, and is backed by a 20-year warranty.

The system has been designed for easy installation, allowing you to save time and money while achieving a professional result.

This is a high-quality and affordable system that's fully customizable and easy-to-install on outdoor decks, balconies and patios.

**Building codes may vary. always comply with your local building codes. For details visit: www.peakproducts.com/en-au/compliance*

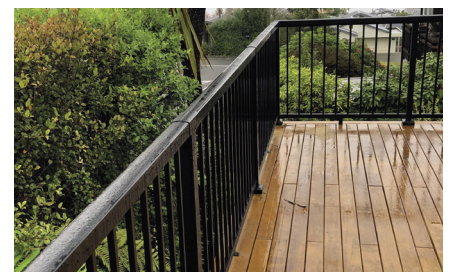

SPECS

- Available in black or white. Choose from Standard or Wide Balusters, Sectional Glass or Large Glass Panels.
- Complies with Australian/ New Zealand Standard AS/NZS 1170.0:2002 Structural design actions*.

Available instore or to order

Speak to the Trade Specialist at your local warehouse or the team at your nearest Trade Centre.



**DESIGN
TOOLS
AVAILABLE**





ALUMINIUM BALUSTRADING

Protector^{Al}



Protector aluminium balustrading has been engineered and manufactured to exceed the mandatory Australian Standards and Building Codes for Australia. It is light, strong, durable and won't rust or rot. This product has been designed for superior strength, easy installation and maximum safety, and includes Ulti-M8 heavy gauge aluminium pickets for ultra-strength core. The shorter spans provide a strong balustrade solution that is easy to install.



This product can be custom ordered in a wide variety of sizes, styles and colours to meet your customer's needs. Raked panels are also available to allow for staircases.

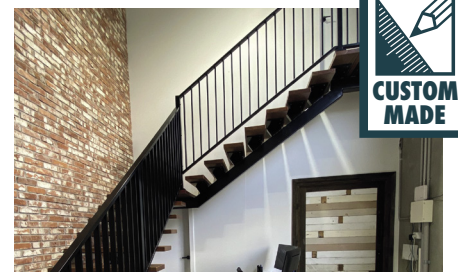

SPECS

- Wide variety of colours available
- Custom made in Australia
- Designed and manufactured to exceed AS1170
- Includes the Ulti-M8, ultra strength core system
- Quality assured 20 year warranty

Available to order

Speak to the Trade Specialist at your local warehouse or the team at your nearest Trade Centre.



PVC PICKET, TIMBERLINE POST AND RAIL FENCING



Made using recycled composite PVC, **Think Fencing's** products are 100% Australian made from 85% recycled materials and are 100% recyclable at end of life. The picket fencing comes in a full range of contemporary and traditional styles and colours and looks equally good from the back or front, whilst Timberline combines the beauty of freshly painted timber with the strength and resilience of advanced recycled Polymers.

Posts can be installed in ground or on a galvanized steel mounting plate fastened onto a concrete base and the fence can be fabricated for installation on a gradient using either a rake or step down (accommodating a 3% gradient as standard for Post and Rail).

The fencing is simple to install with virtually zero maintenance. No painting is required and the product comes pre-coated in a graffiti resistant coating. Matching Gates are available in swing up to 2400mm or sliding up to 6000mm wide.



SPECS

Picket Fence Specs:

- 76x22mm pickets
- 150x50mm bottom rail
- 88x51mm top rail

Post and Rail Specs:

- 1 to 4 rails, from 900mm to 1600mm high
- Post centres as standard 2425mm

Available instore or to order

Speak to the Trade Specialist at your local warehouse or the team at your nearest Trade Centre.





STEEL MESH BOUNDARY FENCING



The **PEAK® No-Dig Mesh Fencing** system is designed to let you install a sturdy fence quickly without digging holes or pouring concrete.

It is made from highly durable steel with rust-resistant finish for long-term exterior use. This provides a fencing system that will look beautiful for many years with little to no maintenance.

With its versatile dig-free design, modern finish and steel construction, the **PEAK® No-Dig Mesh Fencing** can instantly transform any yard. Install to boost kerb appeal or use it as temporary fencing to add safety around a residential home or property lines.



SPECS

- Available in black only
- Fence height of 1200mm, and panels available in 1500mm widths
- Gate with latch also available in 860mm width

Available instore or to order

Speak to the Trade Specialist at your local warehouse or the team at your nearest Trade Centre.



**DESIGN
TOOLS
AVAILABLE**





STEEL BOUNDARY FENCING

LYSAGHT

FIELDERS

Shaped from Australian-made steel, this easy-maintenance fencing provides privacy and security. It is highly durable – it won't rust, peel or crack. It is also non-combustible and fully tested, made to Australian standards.



Trapezoidal



Slats

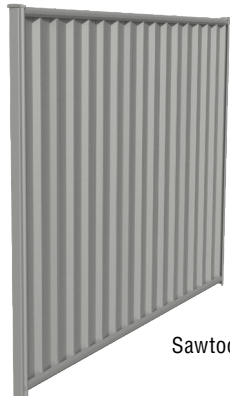

Sawtooth



Corrugated

- Basalt™
- Bluegum™
- Domain™
- Dune™
- Evening Haze™
- Ironstone™
- Monument™
- Pale Eucalypt™
- Paperbark™
- Riversand™
- Shale Grey™
- Surfmist™
- Wilderness™
- Wollemi™
- Woodland Grey™



SPECS

- Available in a choice of colours
- Wide range of panel styles and designs available to order
- Made from Australian steel
- Panels available in 1500mm and 1800mm heights
- Conforms to Australian Standards AS 1926.1 for pool fencing

Available instore or to order
 Speak to the Trade Specialist at your local warehouse or the team at your nearest Trade Centre.

Colorbond®

Additional colours available in project quantities for order in store or online.



STEEL BOUNDARY FENCING

RAPIDFENCE™



RapidFence™ steel square tubular fence range has a sleek and contemporary style. The range includes fence panels, gates and posts, as well as optional toppers for a more traditional look. This range can also be used in a picket style (with toppers) or a flat top style, depending on your customer's preference.

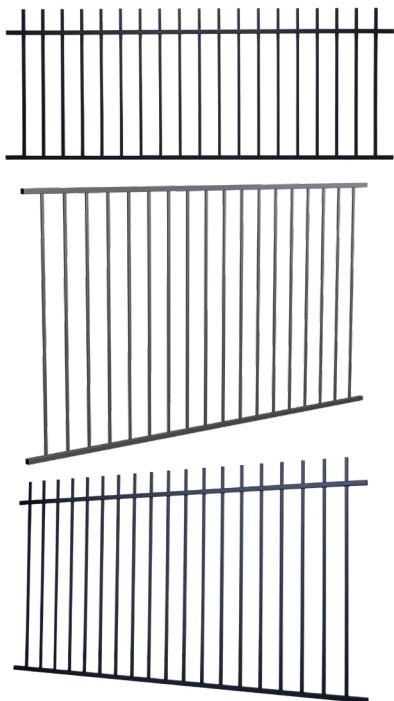

RapidFence™ tubular fence range is made from steel, it's impact-resistant, low-maintenance and will withstand Australia's harsh conditions.



SPECS

- Available in dark grey only
- Panels available in 850mm, 1200mm, 1500mm or 1800mm heights
- Pre Galvanised Steel, Zinc rich Primer and Powder coated

Available instore or to order

Speak to the Trade Specialist at your local warehouse or the team at your nearest Trade Centre.



**DESIGN
TOOLS
AVAILABLE**





STEEL BOUNDARY FENCING



The **Peak**® No-Dig Fencing system is engineered for completely dig-free installation – there's no need to dig holes or pour concrete. This makes it versatile, allowing you to instantly add kerb appeal, protect yards and gardens, install temporary boundary fencing or kickstart a landscaping project.

Designed for the outdoors, this dig-free fencing system is made from highly durable steel with a rust-resistant finish for longevity and reliable strength.



SPECS

- Available in black only in two attractive styles
- Fence height of 1m, and panels available in 860mm and 1200mm widths
- Gates with latches also available in 840mm widths

Available instore or to order

Speak to the Trade Specialist at your local warehouse or the team at your nearest Trade Centre.



**DESIGN
TOOLS
AVAILABLE**



ALUMINIUM BOUNDARY FENCING

Protector^{AL}

This product can be custom ordered in a wide variety of sizes, styles or colours to meet your customer's needs. Raked panels are also available to allow for sloping ground and panels, gates, posts, brackets, and hardware and accessories are also available to complete the job.

Gate Converters have been designed to easily convert a 1200mm high flat top boundary fence panel into a gate, giving you the opportunity to create a custom-sized gate any size up to

2400 wide, simply by cutting the panel to the required size.

Panel Brackets are used for attaching fence panels to posts and walls. These brackets are light, strong, and easy to fit. They allow for some adjustment if your panel is a bit shorter than the gap between the posts.

They also allow for some sideways adjustment if your fence is not in a straight line – approximately 15 degrees (7.5 degrees each way).

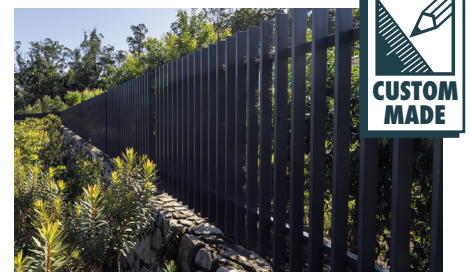

SPECS

- Wide variety of colours available
- Range of profiles available
- Custom Made in Australia
- Standard boundary flat top panels 9000 H x 2400 W

Available instore or to order

Speak to the Trade Specialist at your local warehouse or the team at your nearest Trade Centre.

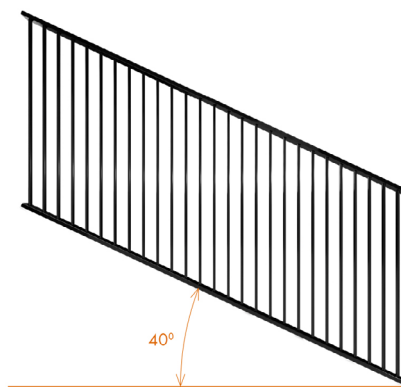
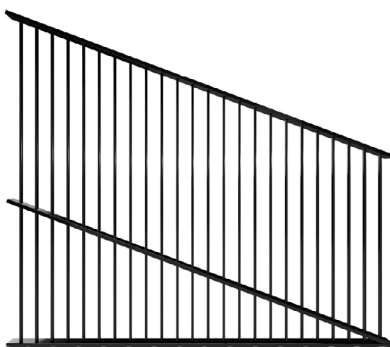



STEEL BOUNDARY FENCING

RAPIDFENCE™

The **RapidFence™** blade fence system is a high-quality, long-lasting steel fencing solution. The low-maintenance, heavy duty, black powder-coated system blends in well with both residential and commercial settings and utilises thick capped steel fence posts to support the strong steel panels and gates.

The Blade Fin style gives a statement, modern, architectural look whilst the Blade Picket gives a timeless look to a property with all the benefits of steel



SPECS

- Available in matte black
- Panels available in 1200mm x 2200mm
- Uses 50mm posts
- Pre Galvanised Steel, Zinc rich Primer and Powder coated

Available to order

Speak to the Trade Specialist at your local warehouse or the team at your nearest Trade Centre.



**DESIGN
TOOLS
AVAILABLE**

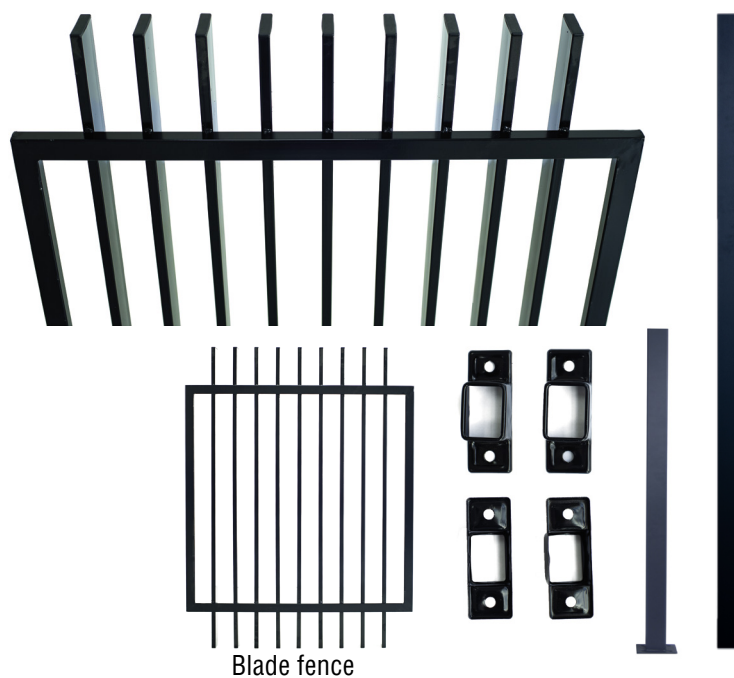

Blade fence



STEEL HYBRID BOUNDARY FENCING

RAPIDFENCE™

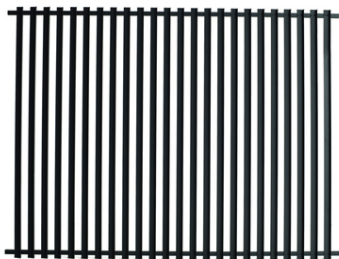

Angle blade fence

The **RapidFence™** angle blade fence system is made from a durable and long-lasting hybrid of steel and aluminium. It's easy to install, and the dark grey colour fits in well in both residential and commercial settings. The aluminium blades of this fence system are angled to maximise coverage with steel railings for improved strength and stability.



SPECS

- Available in dark grey only
- Panels available in 1200mm and 1500mm heights
- Panels compatible with posts and brackets from square tubular fencing range

Available to order

Speak to the Trade Specialist at your local warehouse or the team at your nearest Trade Centre.



**DESIGN
TOOLS
AVAILABLE**





TIMBER FENCING

Bunnings has a wide range of timber Fencing materials to help you complete your timber fencing jobs.

We source our Pickets, available in a range of profiles and species, from many Australian producers that manufacture to suit their local market. In addition to the range available in our warehouses, we have an extended range of styles and sizes available to order, plus posts and plinths to complement the chosen style of fence.

Our Paling fencing is also locally produced, typically in treated pine (selected for durability). Our range of available sizes varies by state, with a range of lengths available. Similarly, fence posts, rails & plinths come in a range of sizes, and lengths with various timber species used.

Bunnings has a zero-tolerance approach to illegally logged timber. Our goal is to ensure all timber and wood products supplied to Bunnings originate from legal and well-managed forest operations.

We have made significant progress in this area, with more than 99 per cent of our whole timber product now sourced from low-risk plantation or other legally verified forest operations. Most of Bunnings' timber products are sourced from independently certified forests or from forests with demonstrated progress towards achieving independent certification.



SPECS

- Picket lengths available in 900mm, 1200mm, 1500mm and 1800mm
- Forest Stewardship Council® (FSC®) certified
- Programme for the Endorsement of Forest Certification (PEFC) certified

Available instore or to order

Speak to the Trade Specialist at your local warehouse or the team at your nearest Trade Centre.





358 HI SECURITY/ANTI-CLIMB MESH



Easy and fast to install, **ARC**'s 358 Security Mesh fencing suits many specialist commercial applications, such as correctional facilities, bridge security, military installations and machine guards. It comes in a black powder coated finish as standard, with a wide variety of colours from the Dulux® Duralloy® powdercoat range allowing you to tailor the product to meet requirements and AS7315 and AAMA 2603 standards.

This product is manufactured in Australia from 100% Australian steel and coated with Zalcote® - zinc aluminium coating to ASNZS4534 Class W10DZ. Meeting the AS2423-2002 welding standard and made with Onesteel / Infrabuild Wire specification, it has an ultimate tensile strength rating of 500 ~ 625 MPA.

Post and rail systems including a range of security fittings and locks for all applications are available. A range of fence toppings and a standard range of single personnel and vehicle double gates, as well as sliding gates, are available. Test data can be supplied by the manufacturer upon request.



SPECS

- Standard sheets 2400mm wide, 1800mm to 3600mm high. Line wire centres 75mm, mesh aperture 46mm x 9mm. Non standard sheets available.
- Manufactured using 4.00mm Lifemax™ XL Medium Wire, wire tolerances +/- 0.08mm
- Lifemax™, HDG or Powdercoated Finish

Available to order

Speak to the Trade Specialist at your local warehouse or the team at your nearest Trade Centre.





CHAIN LINK SECURITY FENCING



PEAK® Wire Grid Fencing is engineered to add security quickly and easily around any home or property. Its smooth finish and clean lines provide a professional, modern aesthetic with the utility of a durable steel perimeter fence. Designed to withstand even the harshest weather, this fence is constructed from steel with rust-resistant protection for lasting durability. The in-ground fence posts are pre-drilled for connecting fence panels, making installation quick and simple.

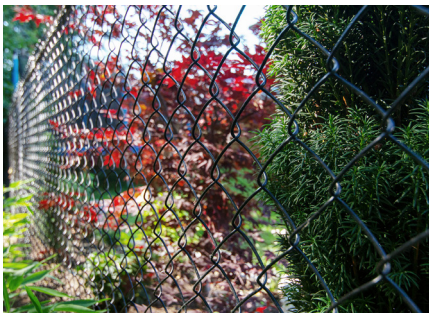

SPECS

- Available in black only
- Fence height of 900mm or 1200mm
- Panels 1200mm high by 1800mm wide
- Gates with latches, adjust to fit openings from 610mm to 1800mm also available

Available to order

Speak to the Trade Specialist at your local warehouse or the team at your nearest Trade Centre.



**DESIGN
TOOLS
AVAILABLE**





STEEL SECURITY FENCING

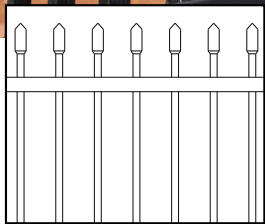

Diplomat Fence

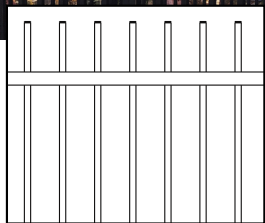
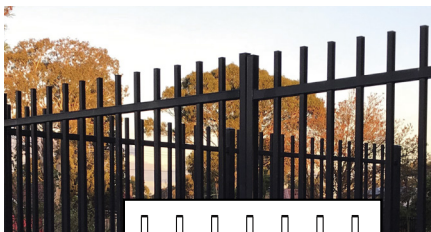

Ambassador Fence

ARC®'s Ambassador™ and Diplomat™ fencing is manufactured in Australia from quality galvanised steel. It suits many commercial applications, such as schools, businesses, railways and commercial properties. The product is designed to suit Australia's harsh conditions. It's manufactured and powder-coated locally with Dulux® Duralloy® premium powder-coating, featuring advanced durable polyester thermosetting powder that meets Australian Standard AS3715.

The standardised panels and gates come in a black powder-coated finish. There is also a wide variety of colours from the Dulux® Duralloy® powder-coat range to allow you to tailor the product to meet your customer's needs.



SPECS

- Wide variety of colours available
- Made in Australia from 70% recycled steel
- Ambassador available in heights from 1800mm, 2100mm or 2400mm and widths of 2000mm or 2400mm
- Diplomat available in heights from 1800mm, 2100mm or 2400mm and 2400mm width
- Compliance certificates can be provided

Available to order
Speak to the Trade Specialist at your local warehouse or the team at your nearest Trade Centre.





ALUMINIUM AND STEEL SECURITY FENCING

Protector^{AI}

Protector Aluminium™ offers both Steel and Aluminium Security Fencing and Gates.

Approved by Department of Education, Training, and Employment (DETE), Aged Care, Childcare Centres,

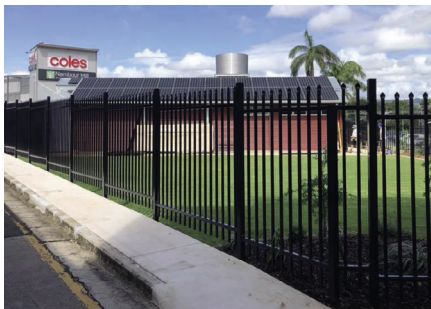

Health and Aquatic and Recreational facilities, the range of security fence panels, posts, pedestrian gates and sliding gates are available to suit your specific requirements.

Both cost effective and strong, the steel range is made from galvanised steel, with silicone bronze welding to prevent rusting on weld locations, then powder coated in Black Satin and come in standard heights and width.

The premium and durable aluminium range is lightweight yet strong and offers superior corrosion resistance and lifespan when compared to steel. The aluminium security panels are powder coated using Interpon™ powder and can be custom made here in Australia, including custom gates, sliding gates, stepped and raked panels.



SPECS

- Wide variety of colours available
- Standard range available in Black Satin powder coat finish, 1800mm & 2100mm high, with 140mm centres
- Panels & gates consist of 40mm square rails with 25mm square pressed spear top pickets
- Powder coated using Interpon powder
- Custom Made in Australia

Available to order

Speak to the Trade Specialist at your local warehouse or the team at your nearest Trade Centre.



WIRE SECURITY FENCING



ARC®'s Wire fencing is manufactured in Australia from quality 5mm OneSteel Lifemax™ wire, engineered to meet Australian standards. Its roll top and bottom suits many commercial applications, such as walkways, machine guarding, railways, schools and sporting grounds.

The product is designed to suit Australia's harsh conditions. It's manufactured and powder-coated locally with Dulux® Duralloy® premium powder-coating, featuring advanced durable polyester thermosetting powder that meets Australian Standard AS3715.

The standardised panels and gates come in a black powder-coated finish. There is also a wide variety of colours from the wide variety of colours from the Dulux® Duralloy® powder-coat range to allow you to tailor the product to meet your customer's needs.

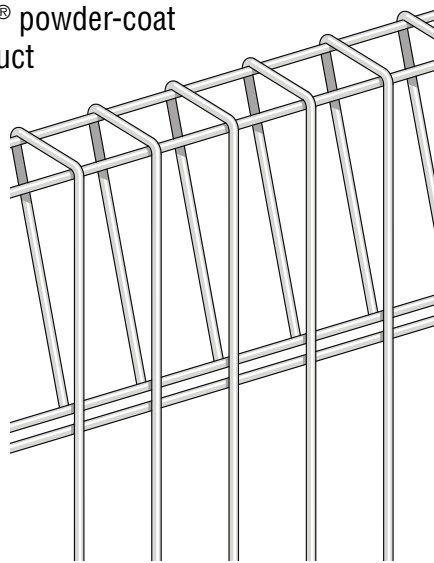

SPECS

- Wide variety of colours available
- Made in Australia from 70% recycled steel
- Meets Australian Standard AS2423 – Coated Steel Wire, Fencing Products for Terrestrial Aquatic and General Use
- Available in heights from 910mm to 1800mm and 2400mm width
- Compliance certificates can be provided

Available to order
Speak to the Trade Specialist at your local warehouse or the team at your nearest Trade Centre.





CHAIN WIRE SECURITY FENCING



ARC®'s chain wire fencing uses long life zinc coated alloy wire and features secure knuckle joints that resist deformation. This versatile product delivers long-term, durable performance and is easy to erect. It has dozens of commercial and rural applications, including schools and playgrounds, sports facilities, boundary, industrial and security fencing, and farm and machine guards.

It can be produced using galvanised steel wire or PVC-coated wire, with the PVC coating available in black or dark green. It is available in full custom height and aperture options.

The product is designed to suit Australia's conditions and has been made in Australia since the 1930s.

An integrated range of installation and associated fencing products is available, including intermediate and terminal posts, pipe rails and lacing and tie wire.



SPECS

- Made in Australia from more than 70 percent recycled steel.
- Available in widths of 600-3600mm, in increments of 300mm.
- Available in rolls of 10, 15, or 20m.
- Wire size 2.50mm or 3.15mm.
- Mesh size 45mm or 50mm.
- Engineered to meet Australian standards AS1725-2010.
- Compliance certificates can be provided.

Available to order

Speak to the Trade Specialist at your local warehouse or the team at your nearest Trade Centre.





FORTRESS GATE KITS



Fortress Gates' kits are manufactured from 25mm x 25mm square galvanised steel tubing with sturdy welded joints; the frames won't rot or warp. Customers will love the versatility of these kits. They come in a variety of sizes and options, and the frames provide flexibility for different cladding to be added later if your customer would ever like to change it.

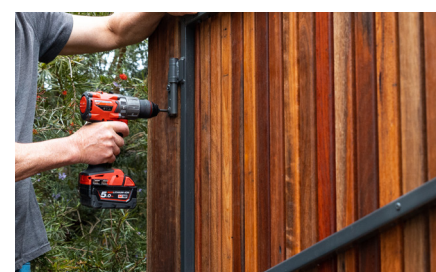

SPECS

- Made in Australia
- 25mm x 25mm square galvanised steel tubing
- Easy to change reversible hinges for left and right-hand opening

Available instore or to order

Speak to the Trade Specialist at your local warehouse or the team at your nearest Trade Centre.





STEEL DRIVEWAY & PEDESTRIAN GATES



Masterworks Gates are made for strength, style and durability, crafted from thick, high-quality steel and welded by hand. They are available in three designs (ranging from classic Victorian to a contemporary design) and are available as driveway gates, pedestrian gates and accompanying fence panels in a variety of widths and heights.



SPECS

- Available in black
- Lifetime Warranty

Available to order
Speak to the Trade Specialist at your local warehouse or the team at your nearest Trade Centre.





ALUMINIUM DRIVEWAY & PEDESTRIAN GATES

Protector^{Al}



Protector Aluminium™ driveway and pedestrian gates are available in a range of designs and can be manufactured to suit your specific style, height, width, and colour needs. Available as automatic sliding or swing, standard options, or custom-made.

The standard black range is available in a variety of profiles, including batten and radiator style, slats and louvres. A vast custom-made-to-order offer, which caters for your specific client's design specifications, can also include stepped and raked additions.

Custom-manufactured in Australia, Protector Aluminium also offers an extended G8Safe gate hardware range, as well as a variety of automation options depending on weight, overall length, and duty cycle. Sliding and swing options available in either hardwired or solar powered.

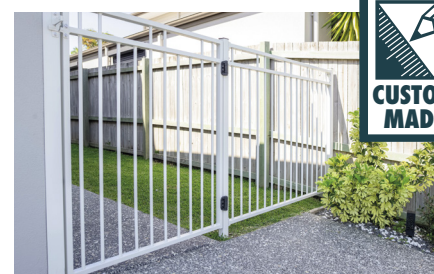

SPECS

- Custom design & manufacture available
- Custom made in Australia

Available to order

Speak to the Trade Specialist at your local warehouse or the team at your nearest Trade Centre.





STEEL TEMPORARY FENCING

RAPIDFENCE™

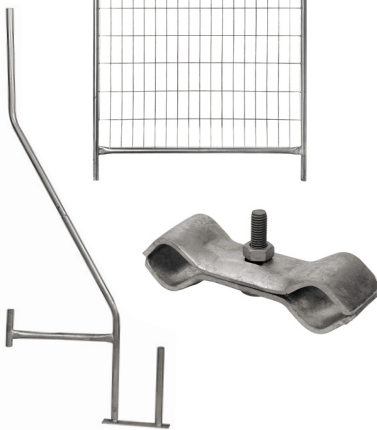
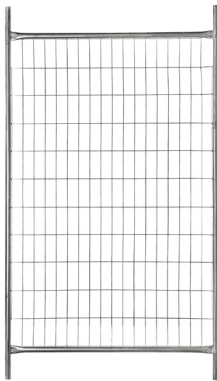
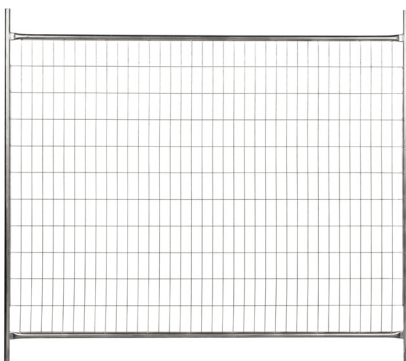

Get your site set up right with **RapidMesh™** temporary fencing. It provides the strength and durability of hand-welded steel along with specially designed anti-climb mesh, so you can be sure your site is secure. It is available in full, half and multi-purpose modular panels so you can erect fencing that easily adapts to your needs. There are a range of accessories available to complete your fencing, including panel hinge, wall brackets, spike feet, clamps, hinges, blow mould concrete fill bases, support stays and jockey wheels.



SPECS

- Complies with Australian Standard AS4687-2007 Temporary Fencing and Hoardings
- 2400mm wide, 2100mm high & 32mm deep
- Panels weigh 11kg
- Half panels available

Available instore or to order

Speak to the Trade Specialist at your local warehouse or the team at your nearest Trade Centre.



STEEL TEMPORARY POOL FENCING

RAPIDFENCE™

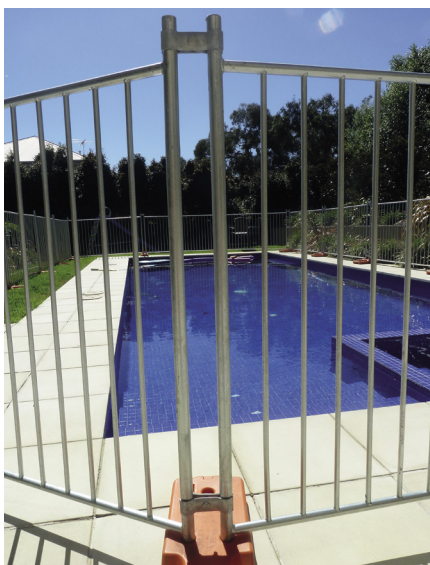

Ensure your site is safe and compliant with **RapidMesh™** temporary pool fencing panels. They are made from durable hot dipped galvanised steel with specifications that meet the compliance regulations of most council bodies, giving you peace of mind while you get on with the job. There are a range of accessories available to complete your fencing, including a pool fence gate, fence feet and clamps.



SPECS

- Pool fence system complies with the Australian Standard AS1926 Safety Barriers for Swimming Pools
- Panels 2300mm wide, 1350mm high & 32mm deep
- Gate 1040 wide, 2230 high & 40mm deep

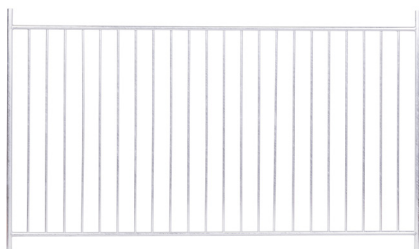

Available to order

Speak to the Trade Specialist at your local warehouse or the team at your nearest Trade Centre.

Helping business
is our trade.

Trade contact:

Trade Centre/Warehouse:

Phone number:

Email:



Place an order for your fencing needs with the Trade Specialist at your local Bunnings store (in-store or over the phone), at your local Bunnings Trade Centre or online. If you can't see the product or range that you need in-store, please ask us. We're here to help.

Here are a few of the benefits of having a Trade account with Bunnings:

- A dedicated Trade Team
- Exclusive Trade pricing and offers
- One account across all locations
- Flexible account options
- Convenience with the PowerPass app.

BUNNINGS
TRADE

Helping business is our trade.