

TOOLS REQUIRED

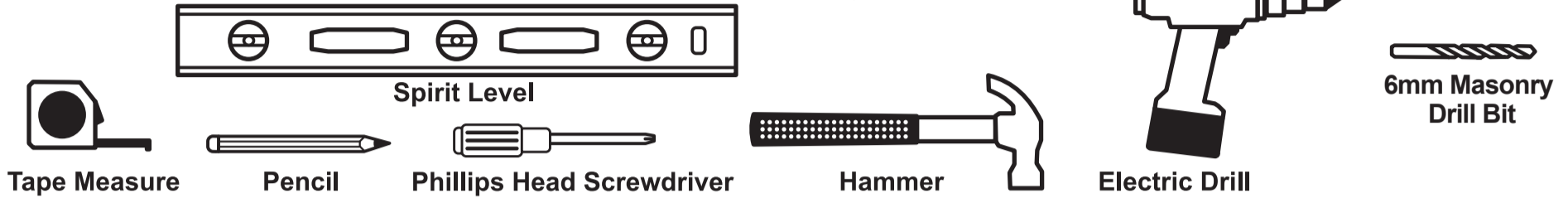

LIST OF PARTS

IMPORTANT:

Check that you have all parts as listed.
Depending on the configuration you choose, you may not use all components supplied.
Anchors for stud and plaster walls are included. Anchors for concrete or steel walls must be purchased separately.
Read through instructions before commencing assembly and see Recommendations above.

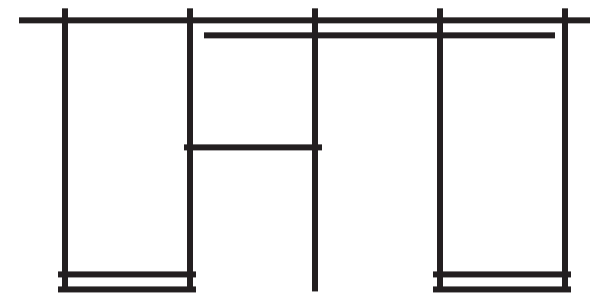

PRODUCT



**Flexi Storage Home Solutions
2.4M Wardrobe Starter Kits**

Description	Product	Code	Qty	
Wire Shelf - Front "A" 1225/920mm x 335mm	(A)	SA1225	1	
	(B)	SA920	1	
Wire Shelf - Back "B" 1225/920mm x 350mm	(A)	SB1225	1	
	(B)	SB920	1	
Wire Shelf - Front "A" 666mm x 335mm	(A)	SA666	2	
	(B)	SA666	2	
Wire Shelf - Back "B" 666mm x 350mm	(A)	SB666	1	
	(B)	SB666	1	
Double Slot Wallstrip 1206mm	(A)	WS1206	5	
	(B)	WS1206	4	
Wire Shelf Bracket 350mm	(A)	BR350	11 of each	
	(B)	BR350	10 of each	
Hang Track 1219/914mm	(A)	HT1219	2	
	(B)	HT914	2	
Hanging Rod Bracket	(A)	RH	9 of each	
	(B)	RH	8 of each	
Hanging Rod Ø 23.7mm x 1219/914mm - Inner Rod	(A)	HR1219	1	
	(B)	HR914	1	
Hanging Rod Ø 25mm x 1219/914mm - Outer Rod	(A)	HR1219	1	
	(B)	HR914	1	
Hanging Rod Ø 23.7mm x 660mm - Inner Rod	(A)	HR660	1	
	(B)	HR660	1	
Hanging Rod Ø 25mm x 660mm - Outer Rod	(A)	HR660	1	
	(B)	HR660	1	
Hang Track Cover Strip	(A)	CS558	4	
	(B)	CS558	3	

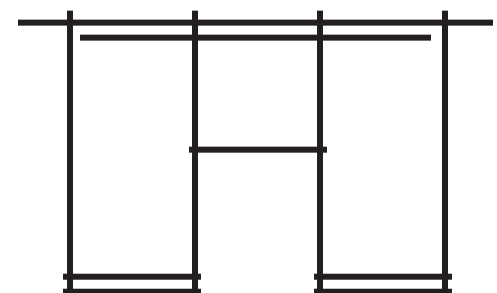

PRODUCT



**Flexi Storage Home Solutions
1.8M Wardrobe Starter Kits**

Parts listed below: the Screws and Anchors are supplied in a hardware bag,
the Hang Track Cover Strip and Rod End Covers are supplied in their own separate bags

Screws	(A)	-	21	
	(B)	-	18	
Plasterboard Plugs	(A)	-	18	
	(B)	-	15	

1 Mount Hang Tracks

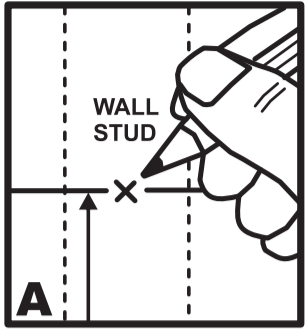

Locate all wall studs on closet wall and mark with an 'X' at the maximum height you require your system to be positioned.
NOTE: Please consider the maximum height of the Wallstrips to ensure there is ample clearance from the floor.

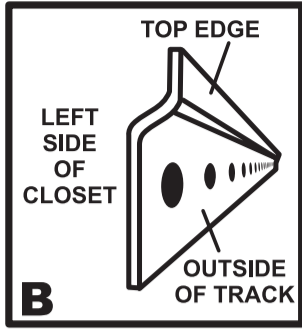

Position first Hang Track so that the track is touching the left side of the closet (if that is where you wish to install your system, otherwise start at a point in the closet that best suits your needs).

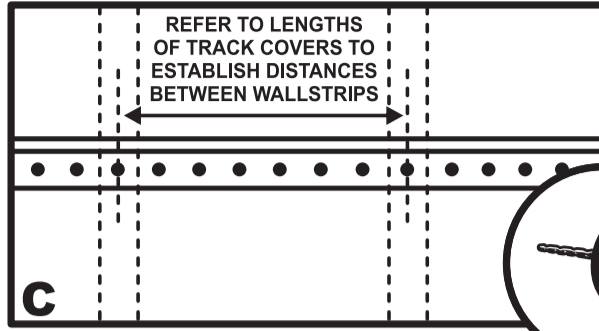

Using a spirit level to ensure Hang Track is level, mark the holes where the wall studs are, then drill a pilot hole.
NOTE: If wall studs are not available, please use Plasterboard Plugs (supplied) or suitable Masonry Plugs (not supplied).

If there is no wall stud to fix a screw through the second hole from the left, please ensure you use a suitable wall anchor. (see Steps 1 and 2 below).

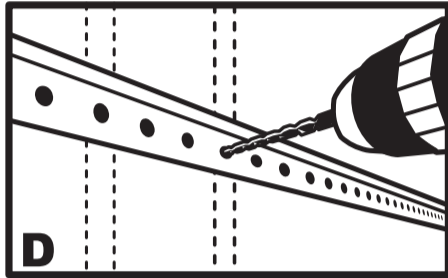

Starting at left side, fasten the FIRST TWO screws into studs (or anchors). Do not fasten remaining screws until after next step.
NOTE: Screws need to be fastened through Track into EACH wall stud.

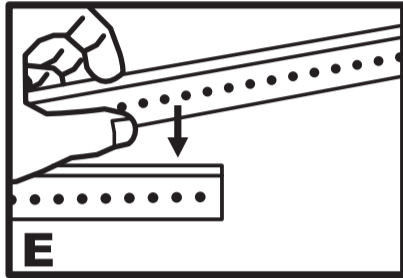

Slide second Hang Track down behind the first from above.

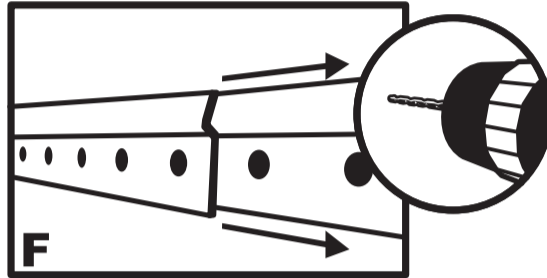

Slide second Hang Track to the right wall of the closet, and then back it away from the right wall until the holes in the two Tracks line up. Repeat Step C to secure to the wall.
If there is **NOT** a stud at the RIGHT end of the Hang Track, repeat the wall anchor installation. (Steps 1 & 2 above).

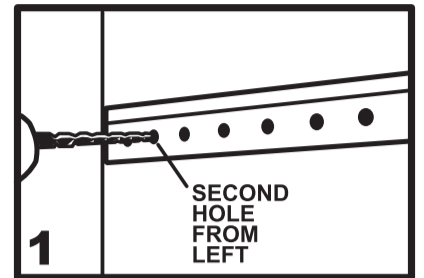

Mark and drill a hole (for a wall anchor) in the second Hang Track hole from the left.

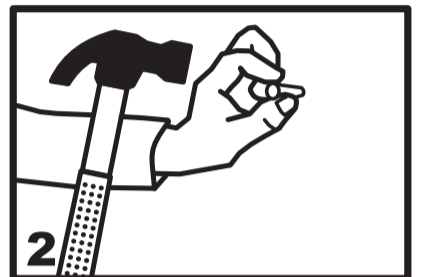

Hammer the wall anchor flush to the wall in the drilled hole.

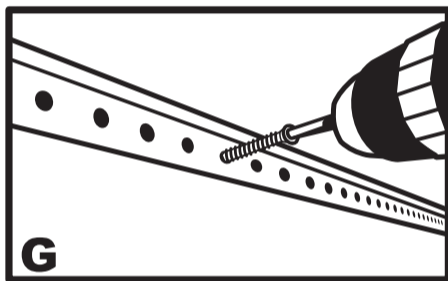

Install screws into studs (or anchors) along Hang Tracks

2 Hang Wallstrips

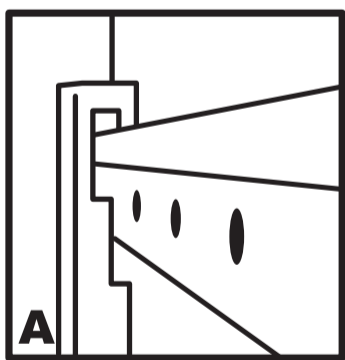

Hang first two Wallstrips over the Hang Track.

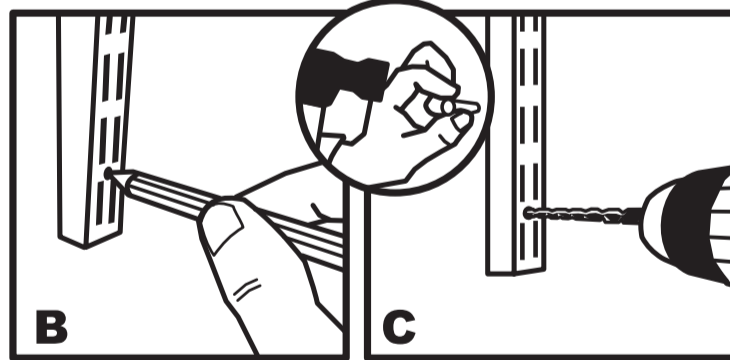

Mark bottom hole of Wallstrip. Drill a pilot hole into the stud (or wall anchor if no stud is available).

Fasten screw into stud or wall anchor.
NOTE: No screws are needed in top holes of Wallstrips.

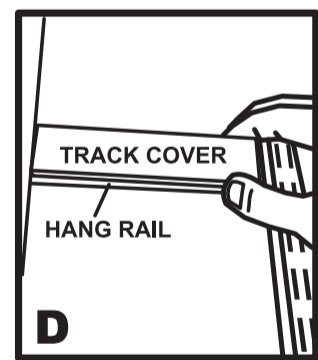

Clip Hang Track Cover over Hang Track

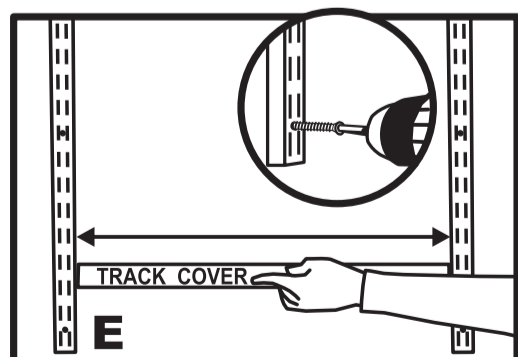

Hang another Wallstrip on the Track and use one of the Track Covers to space apart (ie 558mm). Drill a pilot hole and fasten screws in bottom hole of Wallstrip. (Use wall anchor if there is no stud). Place Track Cover over Track between Wallstrips. Repeat Step F for one or two more Wallstrips (if space allows).

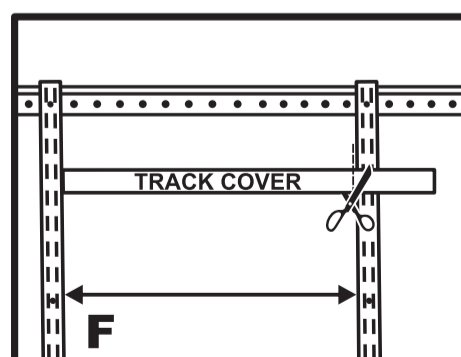

If the space between the last Wallstrip is less than the length of the Track Cover, you may choose to cut Track Cover with scissors to fit.

Please note: if the distance between two uprights is less than a Hang Track Cover Width (ie 558mm) you will not be able to install many of the Home Solutions accessories as they require a 558mm distance (inside to inside) to be installed.

4 Install Brackets & Adjustable Shelves

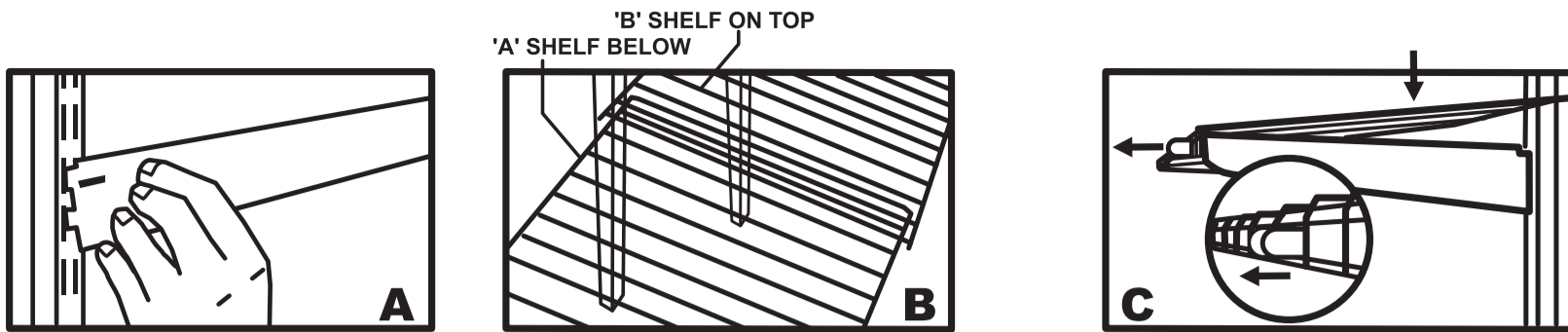

Insert Wire Shelf Brackets into Uprights at desired locations. **NOTE:** Install Wire Shelf Brackets and shelving at the top first and work down. Wire Shelf Brackets will not fit into upper slot of each Upright.

Shelves are fully adjustable and require no cutting. To adjust width, overlap the shelves making sure the shelf labelled A is placed first on the Brackets and the shelf labelled B is placed ON TOP of A.

Make sure the Wire Shelf Bracket locks are unlocked (the plastic locking clip should be in a vertical position - upright) and install shelving making sure that the 'nose' of the Bracket is projecting out through the front edge of the shelf.

NOTE: For maximum weight capacity, do not insert Bracket into bottom slots of Upright.

IMPORTANT: Regardless of overall shelf length, when overlapping sections of shelving, shelves labelled A must be placed onto Wire Shelf Brackets before shelves labelled B.

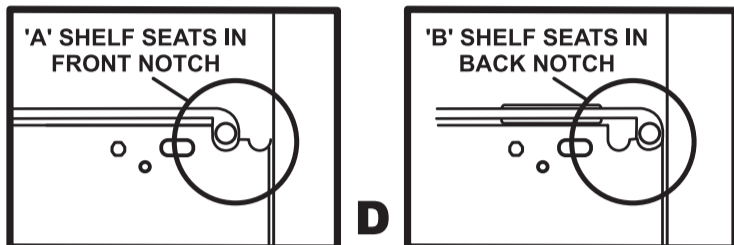

Shelf labelled A sits in front notch of Wire Shelf Bracket. Shelf labelled B sits in back notch. Be sure each shelf slides back as far as possible before locking shelves into Wire Shelf Brackets.

WARNING!

If shelves are installed in the incorrect notch, the front of the shelves may fall off the Wire Shelf Bracket.

If overlapping 3 sections of shelving, use two A section and one B section, placing A sections on the outside and gapping the bridge with the B section. For 4 or more overlapping sections, continue alternating between A and B sections, placing A shelves on Wire Shelf Brackets before B Shelves.

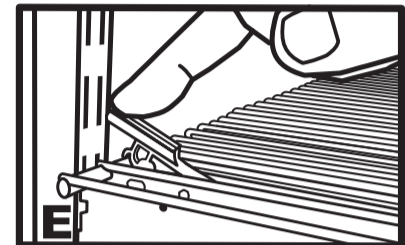

After all shelves are positioned properly, lock shelves into Wire Shelf Brackets by pressing down on the plastic locking clip.

5 Install Adjustable Hanging Rods

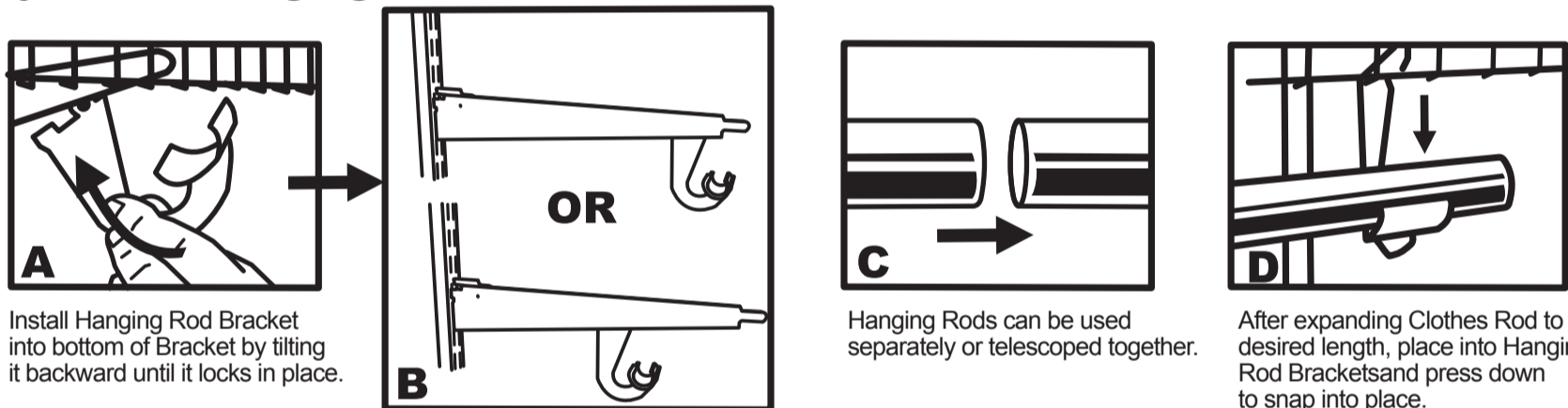

Install Hanging Rod Bracket into bottom of Bracket by tilting it backward until it locks in place.

Hanging Rods can be used separately or telescoped together.

After expanding Clothes Rod to desired length, place into Hanging Rod Brackets and press down to snap into place.

NOTE: Hanging Rod Bracket can be fixed to either of the 2 sets of slots in Wire Shelf Bracket, depending on depth of closet cavity.

Fully Adjustable System

- Wire Shelves and Hanging Rods can be adjusted or reconfigured anywhere on this system to meet your storage needs.
- Additional configurations can be created by overlapping shorter shelves to create longer shelves.
- Change your closet design seasonally to better accommodate summer or winter clothing.

Accessories

All parts are available separately to add to or alter your requirements. These are available from your local Flexi Storage Stockist:

- Sliding Basket Frames
- Sliding Pants Racks
- Single Drawer Unit

Sliding Basket Frames

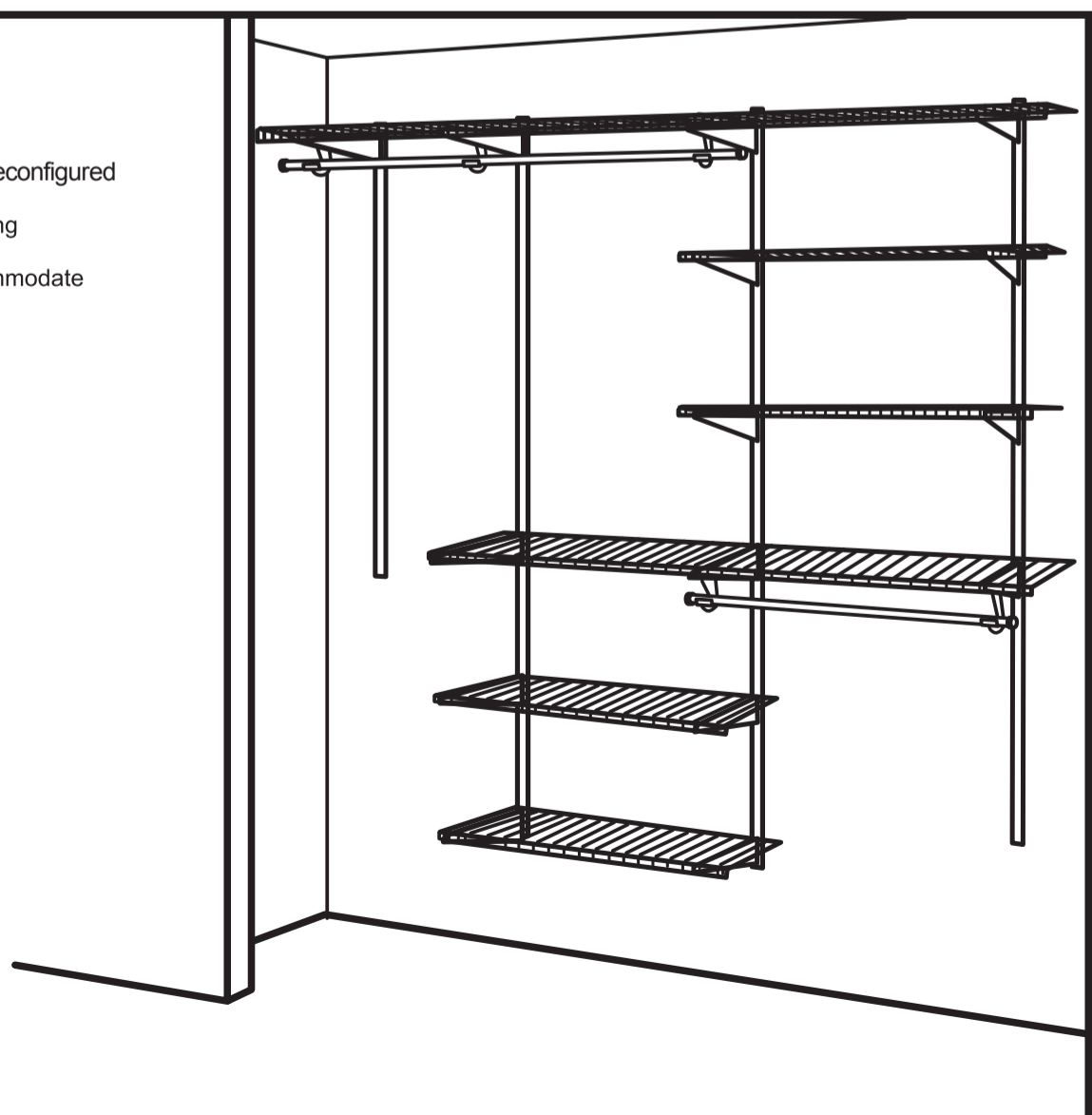

MADE IN CHINA

DISTRIBUTED BY

Visy Retail Services Pty Ltd (AU): 1300 734 714

Visy Board Limited (NZ): 0800 443 058