



RPH361800



### IMPORTANT!

It is essential that you read the instructions in this manual before assembling, operating, and maintaining the product.

Subject to technical modification.

Safety, performance, and dependability have been given top priority in the design of your cordless power hub inverter.

### INTENDED USE

The product may be used for the following purposes:

- operating and charging USB-powered devices
- supplying electrical power for operating compatible AC appliances and devices

The product provides USB A and USB C ports. The main power button must be on for the USB ports to be active. The USB A ports supply 5 V d.c. (up to 2.1 A) charging power. The USB C ports supply 5 V d.c. (up to 3 A), 12 V d.c. (up to 3 A), 20 V d.c (up to 3 A) charging power.

**NOTE:** The USB-dedicated charging ports provide power only; they do not provide any communication capabilities. Suitable USB cables are purchased separately.

The product is intended for indoor use only. Do not use the product for any other purpose.

There may be regulations, local codes, or ordinances that apply to the intended use of the product. Consult a qualified electrician, electrical inspector, or the local agency having jurisdiction:

- In some areas, power inverters are required to be registered with local utility companies.
- If the product is used at a construction site, there may be additional regulations that must be observed.

### GENERAL SAFETY WARNINGS

- Save these instructions. Refer to them frequently and use them to instruct others who may use this product. If you loan someone the product, loan them these instructions also.
- The product should be operated only with the battery packs specified in this manual. When using a battery-operated product, basic safety precautions should always be followed to reduce the risk of fire, leaking batteries, and personal injury.
- Never allow children or people with reduced physical, sensory, or mental capabilities, or persons who are not familiar with these instructions to operate, clean, or maintain the product. Local regulations may restrict the age of the operator. Children should be adequately supervised to ensure that they do not play with the product.
- Stay alert, watch what you are doing, and use common sense when operating the product. Do not operate the product while tired, ill, or under the influence of drugs, alcohol, or medication. A lapse in concentration while operating the product may result in serious personal injury.
- Do not operate the product in explosive atmospheres, such as in the presence of flammable liquids, gases, or dust.
- Do not expose the product to rain or wet conditions. Water entering the product increases the risk of electric shock.
- Never block the air vents. Blocked vents may cause overheating. The product automatically turns off when overheated.

- Keep the product cool. Do not place the product near heat vents or in direct sunlight.
- Do not use the product if it has been dropped or received a sharp blow. A damaged power source increases the risk of fire.
- Do not put foreign objects into the product.
- Do not use any attachments or accessories that are not recommended by the manufacturer of the product. The use of an attachment not recommended by the manufacturer may result in a risk of fire, electric shock, or injury to persons.
- Operate the product using only the AC power type listed in the product specifications.
- Do not use the product with electrical cords that are worn, frayed, bare, or damaged. Do not power devices with damaged or frayed power cords.
- Do not touch bare wire or receptacles.
- To reduce the risk of damage to the electric plug and cord, pull by the plug rather than the cord when disconnecting the charger from the product.
- Use caution when plugging and unplugging other devices into the product. Do not force plugs into the product.
- If the product is used in a manner not specified by the manufacturer, the protection provided by the product may be impaired.
- Do not overload the product. The product must be used for powering devices less than the product rating.
- Ensure that the cable size of the extension cord is capable of carrying the required load. Inadequate cable size can cause a voltage drop, which can damage the product and overheat the cord.
- The operating voltage and frequency requirements of all electronic equipment should be checked before plugging them into the product. Powering equipment that is not designed to operate within a  $\pm 10\%$  voltage variation and  $\pm 3$  Hz frequency variation from the product nameplate ratings may result in damage to the equipment. To avoid damage, always have an additional load plugged into the product if solid-state equipment (such as a television set) is used. A power line conditioner is recommended for some solid-state applications.

### POWER HUB INVERTER SAFETY WARNINGS

- The product is an isolated inverter and has double insulation construction. It does not use earth connection for protection.
- Do not power devices that are damaged or with damaged or frayed power cords.
- Be extra cautious to reduce the risk of dropping a metal tool onto the product. Dropping a tool onto the product might cause a spark or short-circuit the battery pack or other electrical part and may cause an explosion.
- Do not use multiple sockets. Connect only one device to each AC outlet.
- Do not wire the product into an AC distribution circuit.
- Do not hard-wire the product into a circuit.
- Do not use the product to provide power for emergency medical equipment or life support devices.
- Do not use the product to jump-start vehicles. Doing so could result in damage to the vehicle or its electrical components.

- The product must not be connected to other power sources except with another power hub inverter with the same model using the parallel kit.
- The product should only be used on flat, level, stable surfaces and should be secured when possible. Do not pull at cords that can cause the product to tip over.

### BATTERY SAFETY WARNINGS

- Never smoke or allow a spark or flame near the battery pack.
- Remove personal metal items, such as rings, bracelets, necklaces, and watches when working with a battery. A battery can produce a short-circuit current high enough to weld a ring or the like to metal, causing a severe burn.
- Under abusive conditions, liquid may be ejected from the battery; avoid contact. If contact accidentally occurs, flush with water. If liquid contacts eyes, additionally seek medical help. Liquid ejected from the battery may cause irritation or burns.
- Do not use a battery pack or tool that is damaged or modified. Damaged or modified batteries may exhibit unpredictable behaviour resulting in fire, explosion, or risk of injury.
- Do not expose a battery pack or tool to fire or excessive temperature. Exposure to fire or temperature above 130 °C may cause an explosion.
- To reduce the risk of fire, personal injury, and product damage due to a short circuit, never immerse the product, battery pack, or charger in fluid or allow fluid to flow inside them. Corrosive or conductive fluids, such as seawater, certain industrial chemicals, and bleach or bleach-containing products, etc., can cause a short circuit.

### CHARGER SAFETY WARNINGS

- Follow all charging instructions, and do not charge the battery pack or tool outside the temperature range specified in the instructions. Charging improperly or at temperatures outside the specified range may damage the battery and increase the risk of fire.
- Recharge only with the charger specified by the manufacturer. A charger that is suitable for one type of battery pack may create a risk of fire when used with another battery pack.
- Do not try to charge non-rechargeable batteries with the product.

### TRANSPORTATION AND STORAGE

- Turn off the product, and remove the battery pack. Allow the product to cool down before storing or transporting.
- Remove all foreign materials from the product. Store the product in a cool, dry, and well-ventilated place that is inaccessible to children. Keep the product away from corrosive agents such as garden chemicals and de-icing salts. Do not store the product outdoors.
- For transportation in vehicles, remove the battery pack, and secure the product against movement or falling to prevent injury to persons or damage to the product.

### TRANSPORTING LITHIUM BATTERIES

Transport the battery in accordance with local and national provisions and regulations.

Follow all special requirements on packaging and labelling when transporting batteries by a third party. Ensure that

no batteries can come in contact with other batteries or conductive materials while in transport by protecting exposed connectors with insulating, non-conductive caps or tape. Do not transport batteries that are cracked or leaking. Check with the forwarding company for further advice.

### MAINTENANCE

- Use only original manufacturer's replacement parts, accessories, and attachments. Failure to do so can cause possible injury, can contribute to poor performance, and may void your warranty.
- Servicing requires extreme care and knowledge and should be performed only by a qualified service technician. Have the product serviced by an authorised service centre only.
- You may make adjustments and repairs described in this manual. For other repairs, have the product serviced by an authorised service centre only.
- To reduce the risk of electric shock, unplug the product from the outlet before attempting any instructed servicing.
- Do not disassemble the product, take it to an authorised service centre if repair is required. Incorrect reassembly may result in a risk of fire or electric shock.
- Turn off the product and remove the battery pack before any cleaning or maintenance task.
- After each use, clean the plastic parts with a soft, dry cloth. Any part that is damaged should be properly repaired or replaced by an authorised service centre.
- Do not at any time, let brake fluids, gasoline, petroleum-based products, penetrating oils, etc., come in contact with plastic parts. Chemicals can damage, weaken, or destroy plastic, which could result in serious personal injury.
- Do not use water to clean the product.

### SYMBOLS ON THE PRODUCT



Safety alert



Read and understand all instructions before operating the product. Follow all warnings and safety instructions.



The product is a potential source of electric shock. Do not expose the product to moisture, rain, or snow. Do not operate the product with wet hands or feet.



Do not expose the product to rain or damp condition.



Class II tool, double insulation

**IP20**

Ingress protection rating

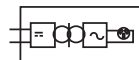

Isolated inverter



Regulatory Compliance Mark (RCM). This product meets applicable regulatory requirements.



Waste electrical products should not be disposed of with household waste. Please recycle where facilities exist. Check with your local authority or retailer for recycling advice.

**5/12/20 VDC**

USB C output

## 2.1A 5VDC

USB A output



Main power / restart button



Charger input jack

**230V AC  
7A MAX**

Maximum AC output



Task light control button



LCD backlight control button



Bluetooth pairing button



AC output / reset button



Parallel kit terminals

## SYMBOLS IN THIS MANUAL



Parts or accessories sold separately



Note



Warning



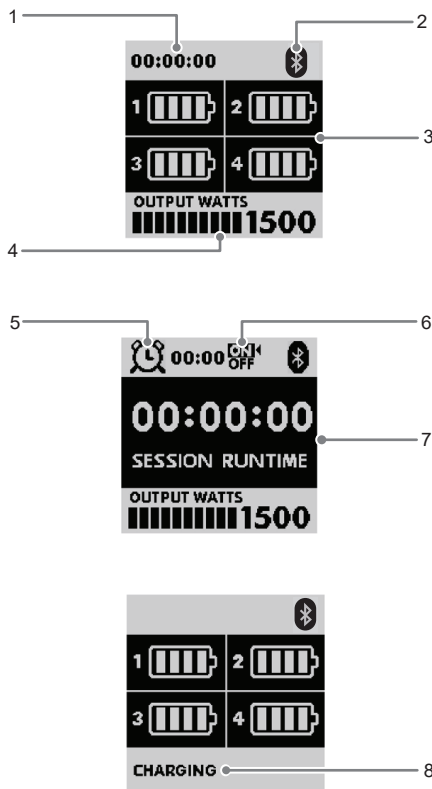

## LCD SCREEN OVERVIEW

The LCD screen displays the status and condition of the product.



1. Session runtime - indicates the current runtime of the product.
2. BLUETOOTH connection - indicates that BLUETOOTH connection is active. The product is BLUETOOTH ready for future wireless features.
3. Battery status - displays the status of the battery packs installed in the product.
4. Output power - displays the working output power of the product.
5. Shutdown timer - if the timer is active, the screen displays the remaining time before the product turns off.
6. Shut down timer on/off - indicates that the shut down timer is on or off.
7. Session runtime (with active timer) - displays the current runtime of the product while the timer is active. To display the session runtime while the timer is active, press the session runtime button.
8. Charging status - indicates that the product is charging a battery pack. Only one battery pack is charged at one time. The active battery bar flashes to indicate which battery pack is charging.

## BATTERY PORT LED FUNCTIONS



LED indicator	Battery pack status	Red LED	Green LED	Description	
	Power	Without battery pack	Solid	-	Ready to charge the battery pack
	Testing	Hot battery pack	Flashing	-	When the battery pack reaches cooled temperature, the charger begins charge mode.
		Cold battery pack	Flashing	-	When the battery pack reaches warmed temperature, the charger begins charge mode.
	Error	Error	Flashing	Flashing	Battery pack or charger error
		Deeply discharged	Flashing	-	The charger conditions the battery pack until normal voltage is reached, then begins charge mode.
		<ul style="list-style-type: none"> <li>■ Reinstall the battery pack. If the LED status repeats a second time, try charging a different battery.</li> <li>■ If a different battery charges normally, dispose of the defective pack (see the battery pack manual for instructions).</li> <li>■ If a different battery pack also indicates an error, replace the charger.</li> </ul>			
	Charging	Fast charging	-	Flashing	The battery is charging.
	Ready	Battery full	-	Solid	Charging is complete.

## TROUBLESHOOTING

Problem	Possible cause	Solution
The product does not turn on.	The battery pack is not charged.	Recharge the battery pack.
	The main power button was released too quickly.	Press and hold the main power button for 2 seconds.
The AC receptacle does not work.	The AC output is not active or the AC power button was released too quickly.	Press and hold the AC output button for 2 seconds.
	The charger is connected.	There is no power output (AC and USB) while the product is charging. Disconnect the charger after the battery packs are fully charged.
	The connected device is defective.	Try a different device.
	The product is overloaded.	Remove the loads and press the AC output button to reset the power hub.
The product unexpectedly turns off.	The battery pack temperature is outside of the normal operating range.	Make sure that the battery pack temperature is between -20 °C and 49 °C.
	The battery pack has low or no charge.	Recharge the battery pack.
	The battery packs are faulty.	Have the product serviced by an authorised service centre.
The charger does not work.	The battery pack temperature is outside of normal operating range.	Make sure that the battery pack temperature is between 0 °C and 45 °C.
	The connection between the battery pack and inverter is not good.	Reinstall the battery pack. If problem persists, use another battery pack.
	The charger's voltage is outside the normal range.	Use another charger.
	The battery pack is defective.	Use another battery pack.

If the problem persists after trying the above solutions, contact your nearest authorised service centre for assistance.

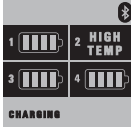
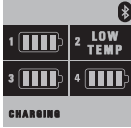
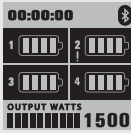
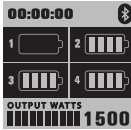
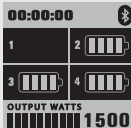
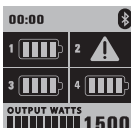
## ERROR MESSAGE NOTIFICATIONS

Error Message	Possible cause	Solution
 <p>High temperature or Low temperature (when the battery pack is installed for charging)</p>	The battery pack is outside the acceptable charging temperature range.	Allow the battery pack to reach the acceptable charging temperature range. The battery may need to be removed from the port and reinstalled to begin charging.
		
 <p>Incompatible battery pack (displays on the specific battery pack slot)</p>	The installed battery pack is not compatible with the product.	Remove the incompatible battery pack. For a list of compatible battery packs, refer to the "Compatible battery packs and power output" section.
 <p>Battery pack is low. (displays on the specific battery pack slot)</p>	The battery charge is low.	Recharge the battery pack.
 <p>No battery pack in slot. (displays on the specific battery pack slot)</p>	There is no battery pack installed. The battery pack is not properly installed.	Remove and reinstall the battery pack.
 <p>Battery fault (displays on the specific battery pack slot)</p>	There are protection features triggered in the battery pack. The communication between the inverter and battery pack fails during charging. The battery pack is defective.	Wait until the protection feature is disabled or when the LCD no longer displays error message. Use another battery pack.
 <p>Overloaded Remove load</p>	The inverter output wattage exceeds normal operating range.	Press the reset button to reset the AC output.
 <p>Overloaded Press reset</p>	The inverter is overloaded.	Press the reset button to reset the AC output.



Heat overload  
Allow unit to cool/  
Press reset

The inverter temperature is out  
of the normal operating range.

Allow the product to cool down  
and reach the normal operating  
temperature.  
Press the reset button to reset the  
AC output.



System fault

There is an internal  
communication error.

Call customer service through the  
following numbers:  
Australia: 1300 697 9624  
New Zealand: 0508 697 9624



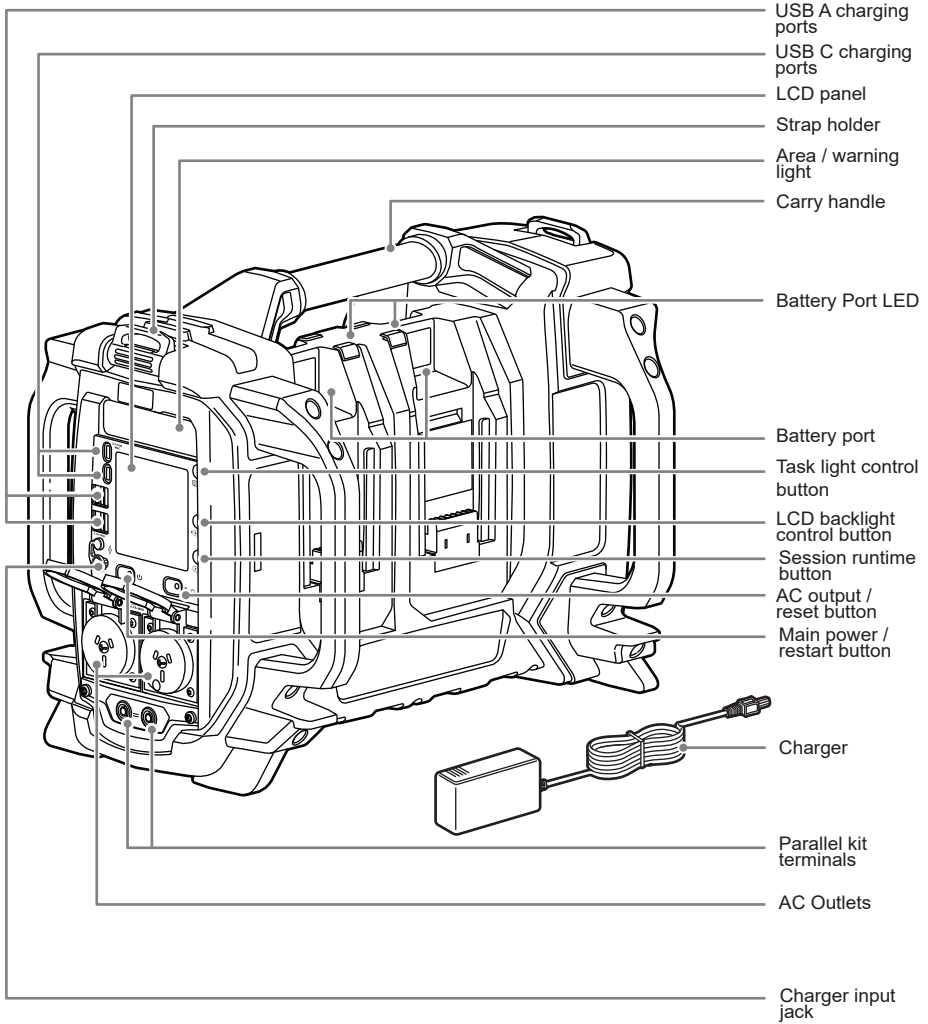

Battery pack





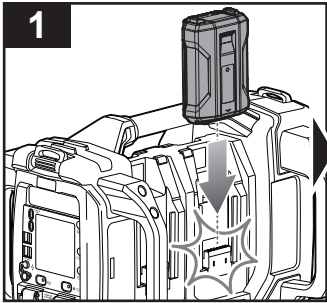

Insert the battery pack until it snaps into place.

**NOTE:** The product has 4 battery ports, but can function even if only one battery pack is installed.

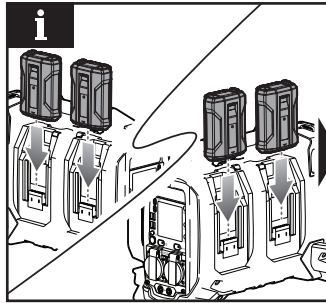

Insert additional battery packs as needed. The more battery packs installed, the greater the amount of power or run time the product can provide.

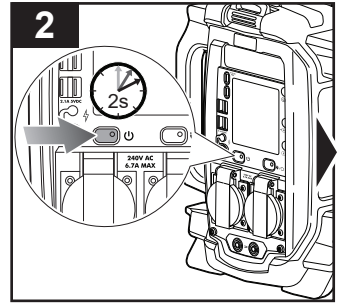

Press and hold the power button for 2 seconds to turn on the product.

**NOTE:** The main power button illuminates when power to the product is on.

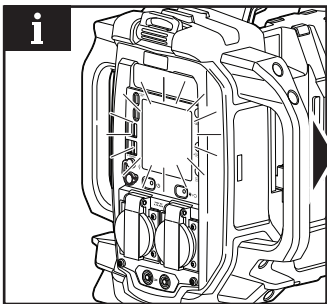

**NOTE:** The LCD panel turns on, and the USB charging ports and LED task light can be used.

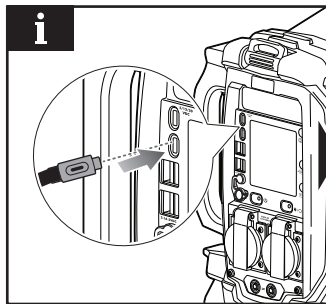

**NOTE:** For charging USB-C specific devices or other devices with up to 3 A, connect these devices to the USB-C ports. The charging ports provide power only; they do not provide any communication capabilities.

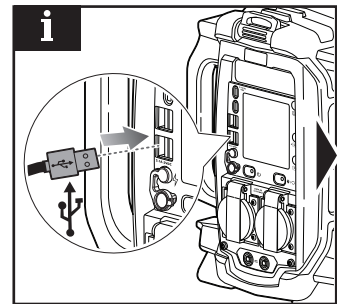

**NOTE:** For charging MP3 players, tablets, and other devices with up to 2.1 A, connect these devices to the USB-A ports. The charging ports provide power only; they do not provide any communication capabilities.

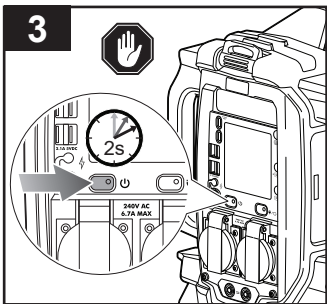

To turn off the product, press and hold the main power button for 2 seconds.

Using the AC outlets

p.11

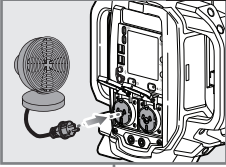

Charging the product

p.12

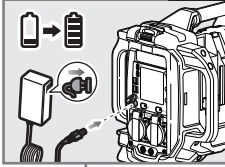

Using the LED task light

p.14

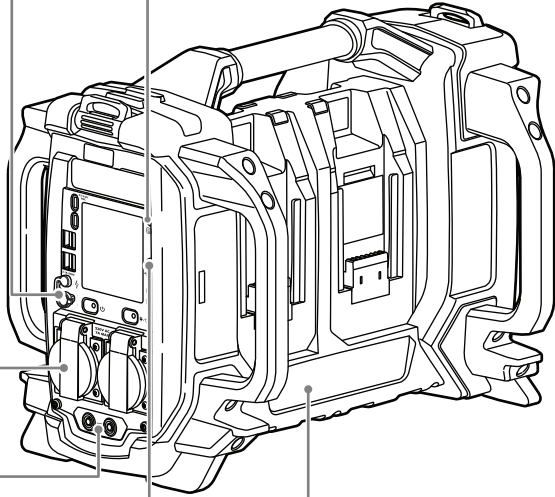
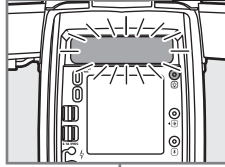

Connecting two power inverters

p.13

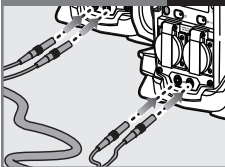

Adjusting the LCD backlight

p.15

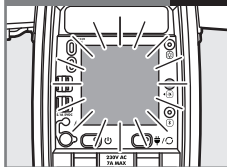

Cleaning and storing the product

p.16

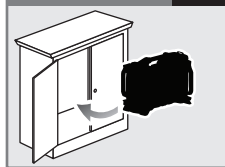

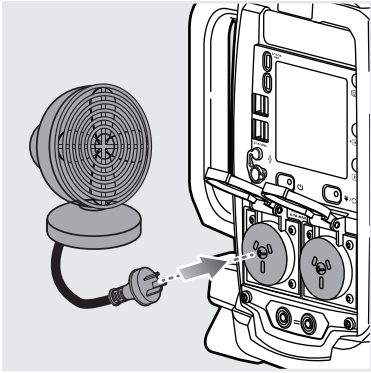

### USING THE AC OUTLETS

1. Insert the battery pack until it snaps into place.
2. Press and hold the main power button for 2 seconds.
3. Press and hold the AC output button for 2 seconds.
4. Open the AC outlet covers.
5. Connect the device to be powered to the AC outlet.

**⚠ WARNING!** Never add more loads than the product capacity. Do not use multiple sockets. Connect only one device to each AC outlet.

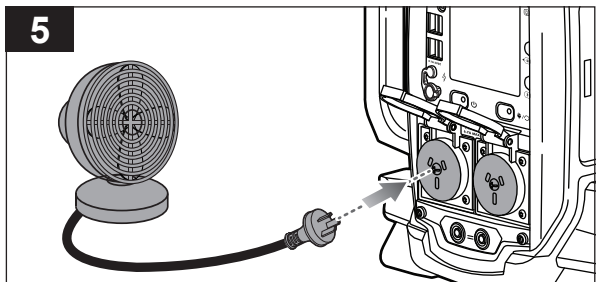
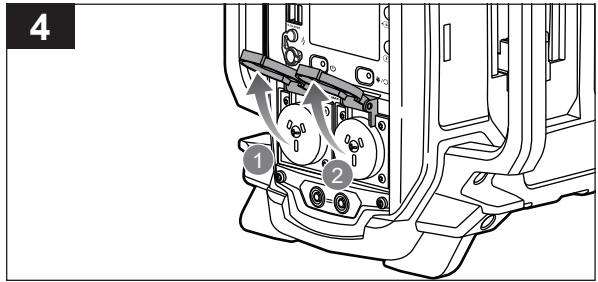
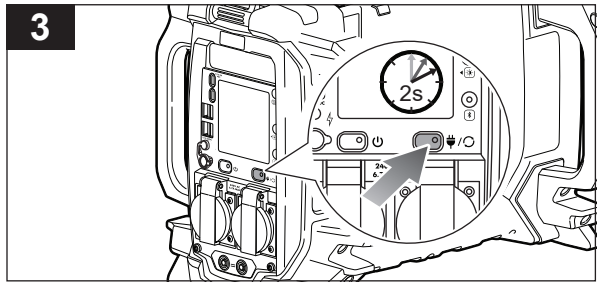
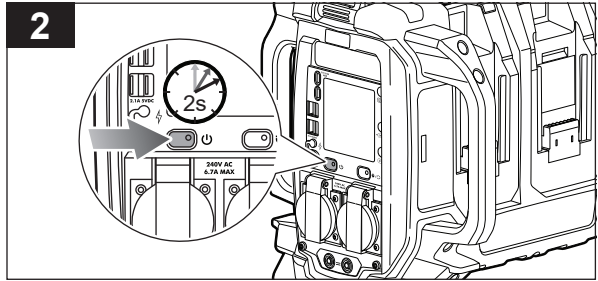
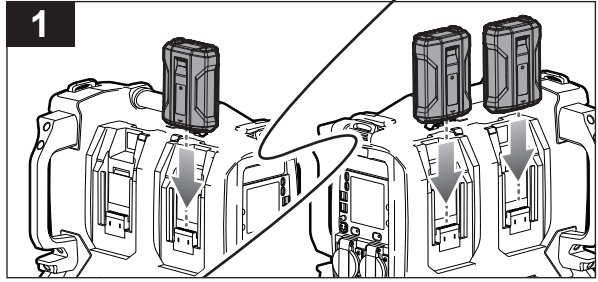

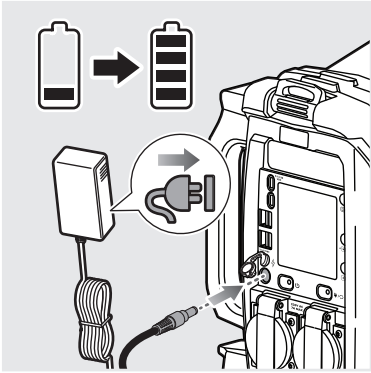

**CHARGING THE PRODUCT**

1. Insert the battery pack until it snaps into place.
2. Connect the charger to the charger input jack.
3. Connect the charger to an AC outlet to charge the product.

**NOTE:** The LCD screen displays the charging status. Only one battery pack is charged at one time. The active battery bar flashes to indicate which battery pack is charging. There is no power output (AC and USB) while the product is charging. Disconnect the charger after the battery packs are fully charged to operate the product.

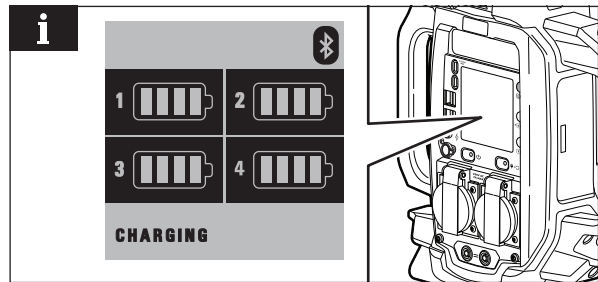
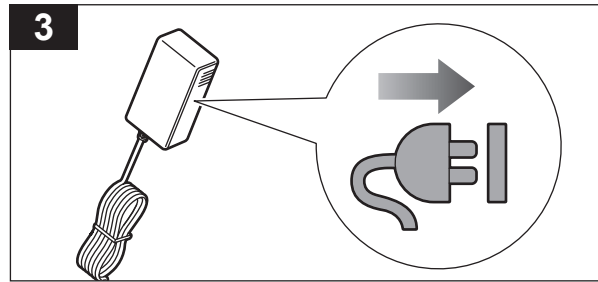
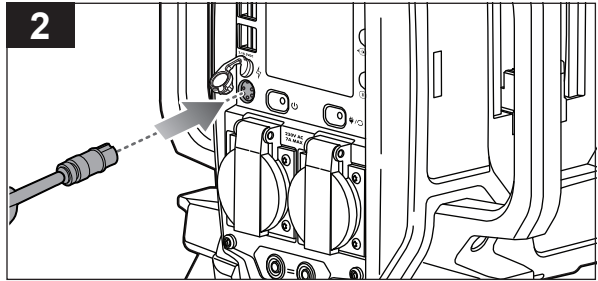
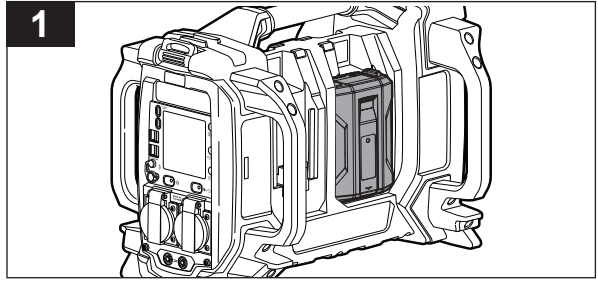

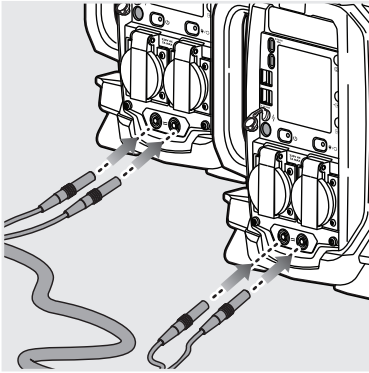

### CONNECTING TWO POWER INVERTERS

**WARNING:** The product must not be connected to other power sources except with another power hub inverter with the same model using the parallel kit cable.

1. Turn off the product, and remove the battery pack.
2. Connect the one end of the parallel kit cable to parallel kit terminals of a power hub inverter. Connect the other end of the cable to the parallel kit terminals of another power hub inverter of the same model.
3. Press and hold the power button for 2 seconds to turn on the product.

**NOTE:** The parallel kit cable links two power inverters to increase output. Do not disconnect the cable while the product is running. The product or the load may be damaged.

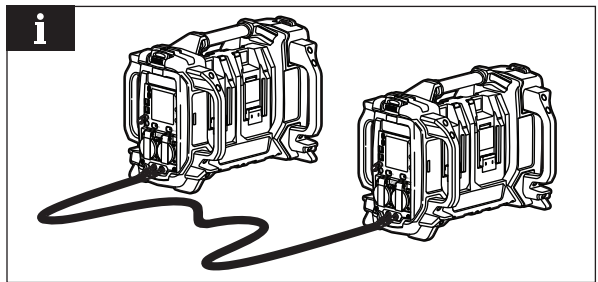
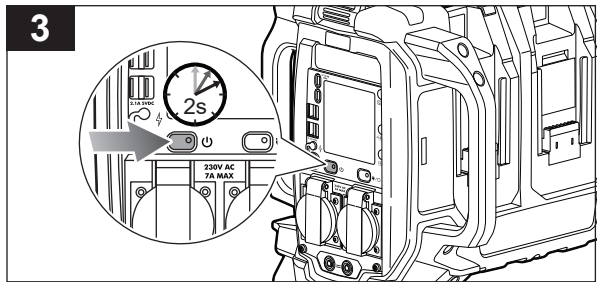
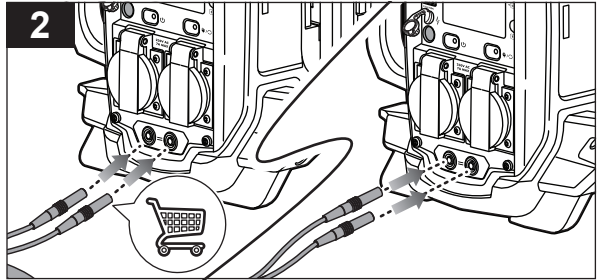
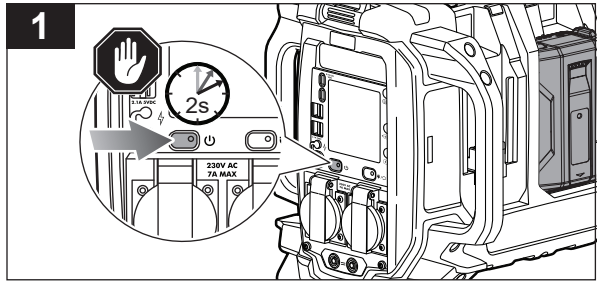

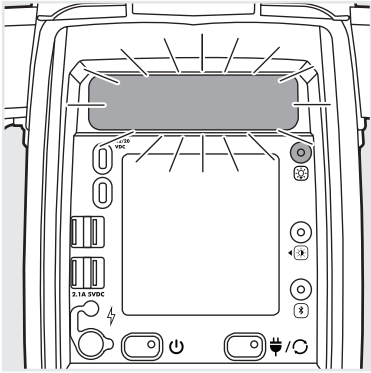

**USING THE LED TASK LIGHT**

**NOTE:** Make sure to install battery packs and to turn on the product.

1. Press the LED task light button to turn on the LED task light.

**NOTE:** The task light illuminates on a high setting. Press the button again to go through other available settings.

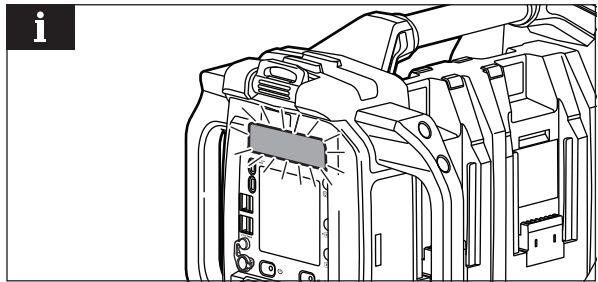
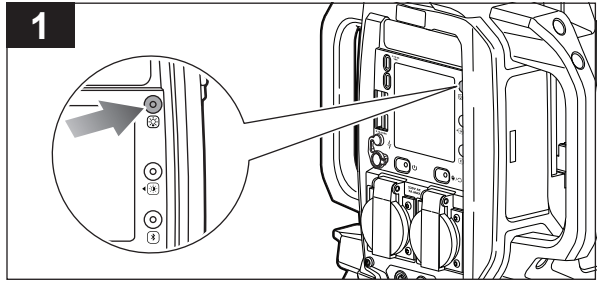
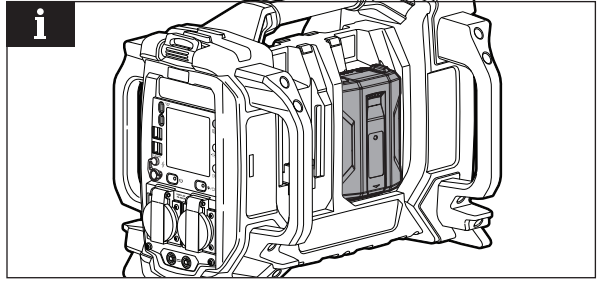

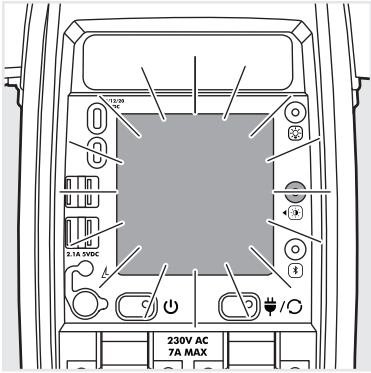

### ADJUSTING the LCD BACKLIGHT

**NOTE:** Make sure to install battery packs and to turn on the product.

1. Press the LCD backlight control button to adjust and set the brightness of the LCD.

**NOTE:** Press the button again to go through other available settings.

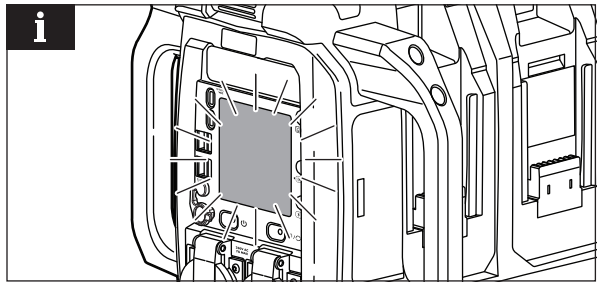
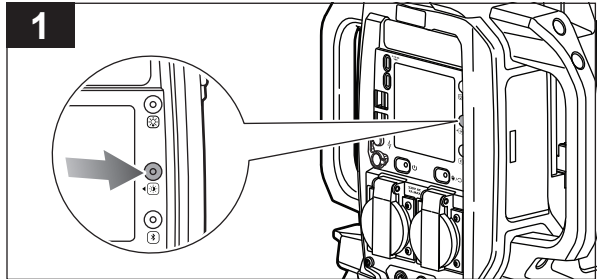
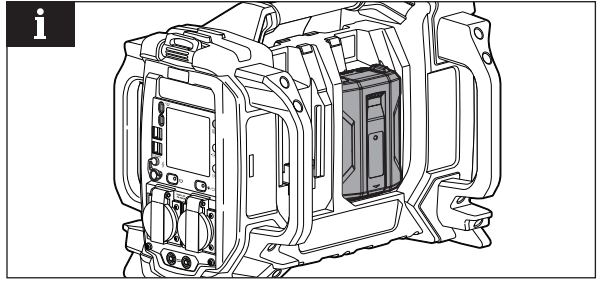

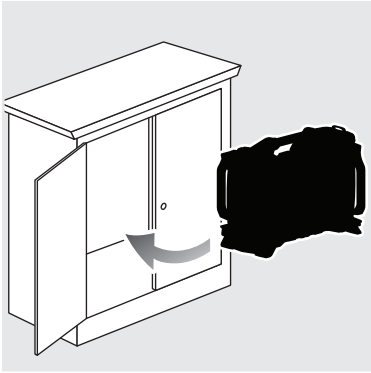

**CLEANING AND STORING THE PRODUCT**

1. Press and hold the main power button for 2 seconds to turn off the product.
2. Remove the battery packs. Allow the product to cool down.
3. Use a clean, dry cloth to clean the product. Do not use water to clean the product.

**NOTE:** Always remove all foreign materials and clean the product before storing.

4. Store the product in a cool, dry, and well-ventilated place that is inaccessible to children. Keep the product away from corrosive agents such as garden chemicals and de-icing salts. Do not store the product outdoors.

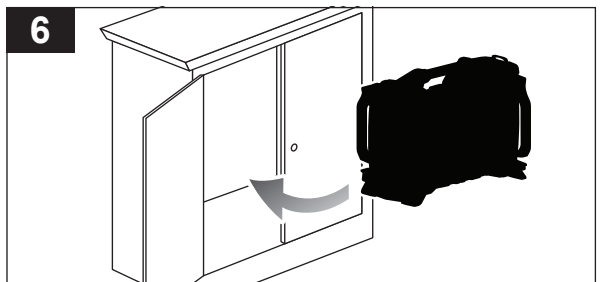
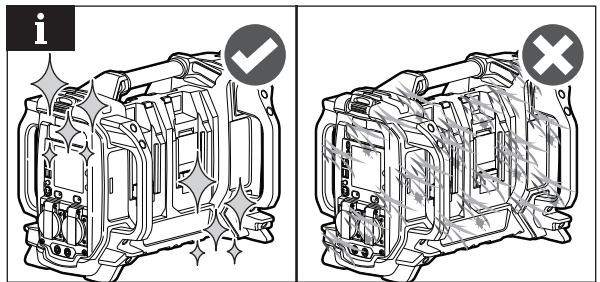
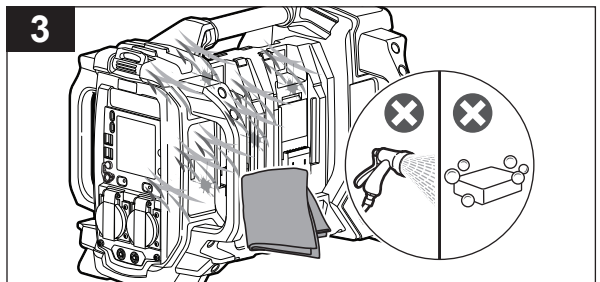
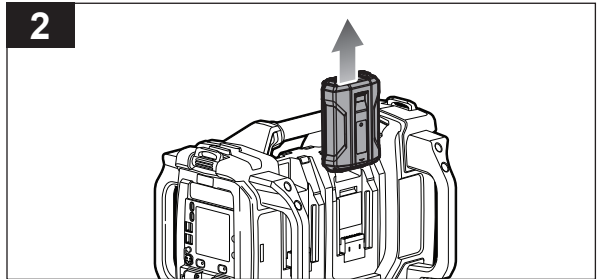
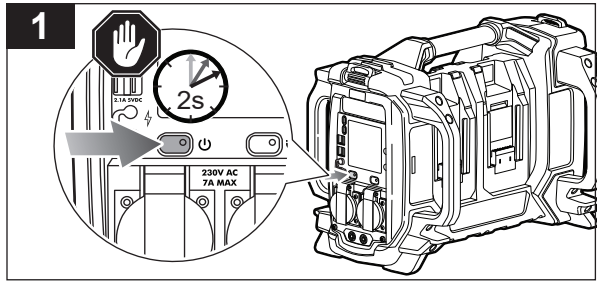



## PRODUCT SPECIFICATIONS

Cordless power hub inverter

Model RPH361800

Rated input voltage 36 V d.c.

DC output

USB A (port 1 + port 2) 5 V d.c.

Total current 2.1 A

USB A (port 3 + port 4) 5 V d.c.

Total current 2.1 A

USB C (each port) 5 V d.c., 3A / 12 V d.c., 3A / 20 V d.c., 3 A

AC Output 230 V a.c., 50 Hz

Power output

Rated AC power output 1600 VA (1800 VA < 3 min)

Surge (starting) power 4500 VA

Charger

Charger input 230 V a.c., 50 Hz

Charger output 36 V d.c.

## BATTERY AND CHARGER

Model RPH361800

Battery pack -

Charger BCL3617S

## COMPATIBLE BATTERY PACKS AND POWER OUTPUT

The working AC power output depends on the battery capacity and the number of battery packs installed in the product.

Compatible battery packs	Battery capacity	Number of battery packs and power output			
		x 1	x 2	x 3	x 4
BPL3620D RY36BTY2	2.0 Ah	700 VA	1500 VA	1600 VA (1800 VA < 3 min)	1600 VA (1800 VA < 3 min)
BPL3640 BPL3640D BPL3640D2 RY36BTY4	4.0 Ah	1350 VA	1600 VA (1800 VA < 3 min)	1600 VA (1800 VA < 3 min)	1600 VA (1800 VA < 3 min)
BPL3650 BPL3650D BPL3650D2 RY36BTY5	5.0 Ah	1350 VA	1600 VA (1800 VA < 3 min)	1600 VA (1800 VA < 3 min)	1600 VA (1800 VA < 3 min)
BPL3660D	6.0 Ah	1400 VA	1600 VA (1800 VA < 3 min)	1600 VA (1800 VA < 3 min)	1600 VA (1800 VA < 3 min)
BPL3612D	12 Ah	1550 VA	1600 VA (1800 VA < 3 min)	1600 VA (1800 VA < 3 min)	1600 VA (1800 VA < 3 min)

**NOTE:** In order to achieve 1800 VA for 3 minutes and then 1600 VA of continuous power, a minimum of two 4.0 Ah battery packs must be used.





*RYOBI is a trade mark of Ryobi Limited, and is used under license.*

*Android is a trademark of Google LLC.*

*IOS is a trade mark or registered trade mark of Cisco in the U.S and other countries and is used under license.*

*The Bluetooth® word mark and logos are registered trade marks owned by Bluetooth SIG, Inc., and any use of such marks by Techtronic Power Tools Technology Limited is under license. Other trade marks and trade names are those of their respective owners.*

© 2021 Techtronic Cordless GP.



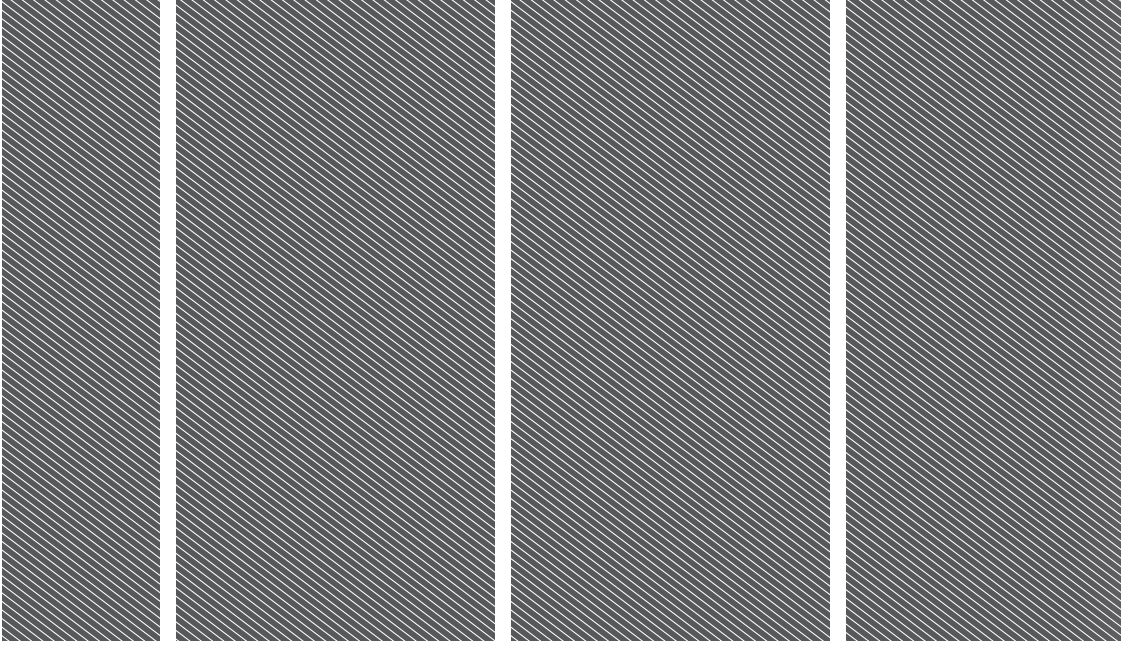

Imported by:  
**Techtronic Industries Australia Pty Ltd**  
31 Gilby Road, Mount Waverley, VIC 3149  
Melbourne, Australia

**Techtronic Industries N.Z. Limited**  
Unit C, 70 Business Parade South,  
Highbrook, Auckland 2013, New Zealand

