



Super Tough Pet Door

Product codes:

#1183, #1122, #1123, #1125, #1126, #1127

**IMPORTANT! READ AND
FOLLOW THESE
INSTRUCTIONS CAREFULLY
AND KEEP FOR FUTURE
REFERENCE.**

INSTALLATION INFO



WARNINGS

WARNING

Please read these cautions and notes carefully before attempting installation. For any questions or concerns, contact Customer Support at www.hakunapets.com/help.

If your home has children as well as pets it is important to remember that children can misuse the pet door and gain access to potential hazards on the other side. You may contravene municipal laws and be found guilty of an offence if there was a swimming pool on the other side of the pet door. You are further advised to be very alert to any future hazards which may occur from time to time on the other side of the pet door such as garden chemicals or insecticides which, even if only put down for a few minutes, would be dangerous to children. Remember that any closing panel or lock provided by Perma Products with this product is for simple convenience and is certainly not a security device. Furthermore we will not be responsible or liable for unintended use or misuse. Please remember it is you the purchaser who must at all times be aware of what you have allowed access to by the installation of this pet door. Please remain vigilant throughout the life of this product as it is you the purchaser who is responsible for any oversight this installation creates.

CAUTION

Before you install this door you must check all your building codes or body corporate rules that could affect the installation of a pet door. You should also check with a qualified builder or trades person that the installation you intend is suitable and safe within the chosen location. This is neither a fire door or security door and it is imperative that you the purchaser consider any risks that may be created both inside and outside after installation of your pet door. Please remember to consider future risks that could be brought about by changes elsewhere on your property.

It is up to the user to take active steps to reduce risks of damage during adverse weather conditions including but not limited to storms or heavy downfalls. This includes manually locking the Pet Door, ensuring adequate measures are taken to ensure your pets safety and sealing the area ensuring the safety of the surrounds.

NOTE

Keep these warnings and cautions with any other important documents in your home and give them to any new owner, tenant or guest so that they too can be made aware of the responsibilities that come with having a pet door within the premises.

PARTS & TOOLS

Parts List

- A. Inner door frame
- B. Outer door frame
- C. Tunnel
- D. Screw Covers (SML:10 / MED:12 / LRG:14)
- E. 12mm Screws (SML:10 / MED:12 / LRG:14)
- F. 45mm Screws (SML:10 / MED:12 / LRG:14)
- G. 58mm Screws (SML:10 / MED:12 / LRG:14)

Tools Required

- Jigsaw
- Drill with 10mm and 8mm drill bits
- Phillips Screwdriver
- Pencil
- Tape Measure / Ruler

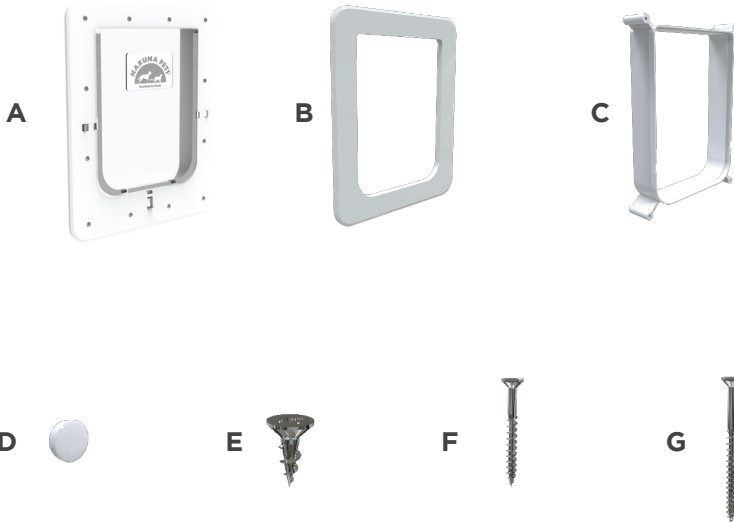

Security Screens: Use 12mm screws (tunnel is not required)

Standard Doors: Align tunnel and frames, secure with 45mm screws

Large Doors & Walls: Align tunnel and frames, secure with 58mm screws

WARNING: Over tightening of screws will cause damage

INSTALLATION

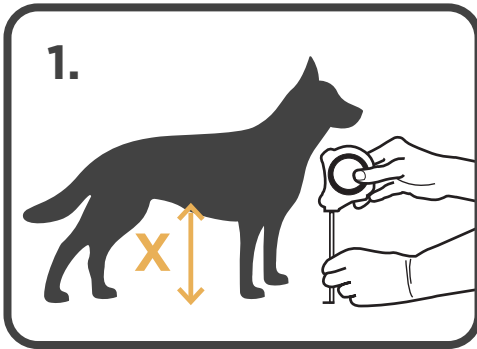

Measure the height (x) from the floor underside of the dog's stomach.

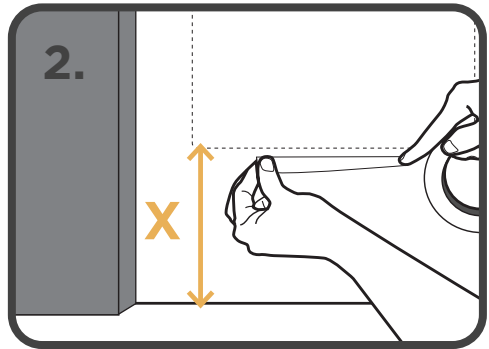

Mark height (x) on door / panel with tape or similar.

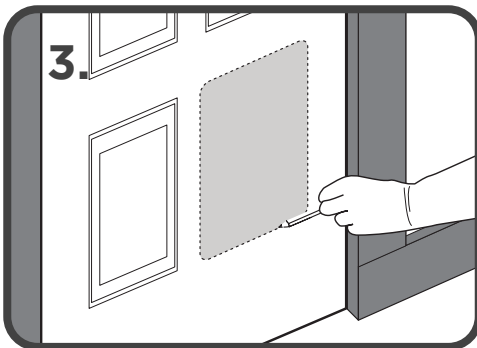

Cut out supplied template, line up with height (x) and trace on to door.

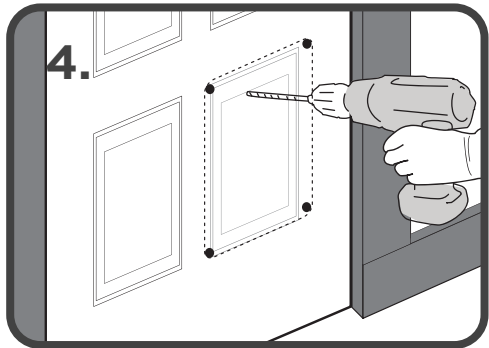

Drill a hole in all four corners with a minimum of 10mm drill bit.

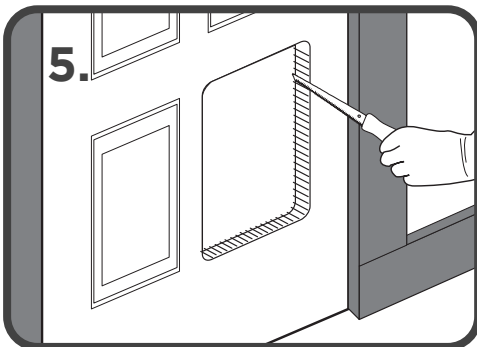

Cut out the opening, cutting along the pencil outline.

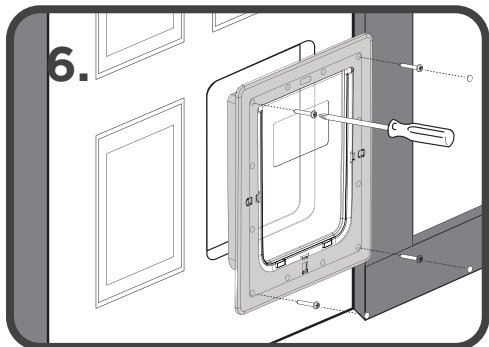

Screw into door / panel from inside.

SECURITY SCREEN INSTALL

Step 1.

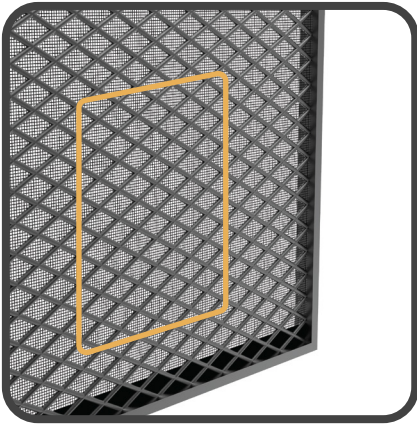

Tape and mark up the measurements needed to cut the opening.

Step 2.

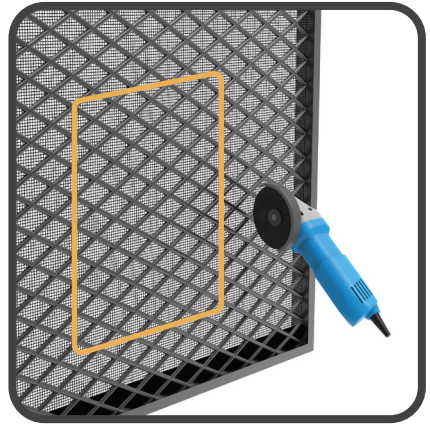

Following steps 1-3 of previous instructions. Using an angle grinder, cut out the opening.

Step 3.

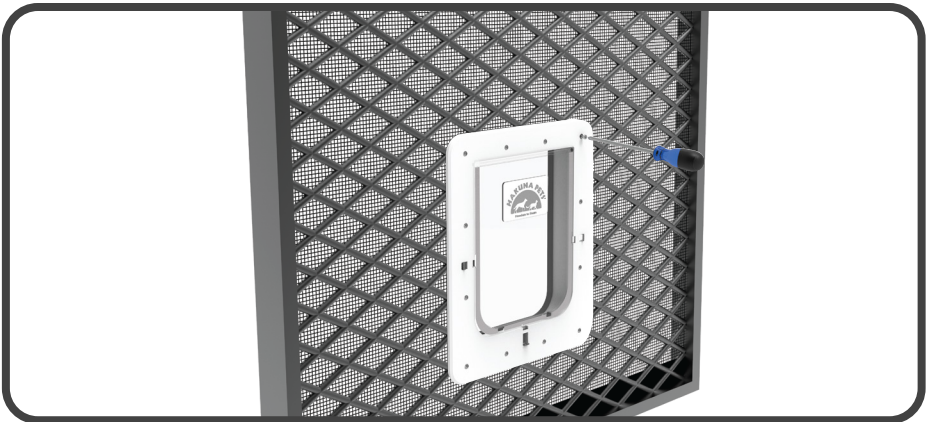

Place both frames into the opening and secure with screws and caps provided. Tunnel is not required.

GLASS DOOR INSTALL

Step 1.

Important:

Contact a professional glazier to cut out the opening for the pet door. If installing into a sliding door, check pet door does not interfere with door operation or any other doors.



Refer to Steps 1 and 2 of “Installation”. Place a bead of construction silicon around the internal section of the pet door and on the surface around the cut out to provide a weather seal. Tunnel is not required.

Step 2.



Insert the inner and outer frame into the cut out and clamp tightly together. Please note the screws provided will not be required for this installation.

TRAINING



Before starting your training, assess whether your dog would be more motivated to come inside through the pet door or go outside through it. If your dog loves being inside the house, you should start this training with them outside. If they're always excited to get outside, start with them inside the house.

1. With your dog on one side of the pet door and you on the other, lift the flap of the pet door all the way up and call them, using an excited voice. Hold treats or your dogs favourite toy so they can see them on the other side of the pet door. Reward any attempt to come towards or through the door with lots of verbal encouragement, but don't let them have the treat until they make it the whole way through. If your dog is hesitating or nervous to approach after trying this step, take a break and come back to it later.
2. When they come all the way through, praise and reward them. Then, leaving them where they are, go to the other side of the pet door, lift the flap and repeat the same exercise. Do a few repetitions going each way, then take a break. This training can be both stressful and exciting for your dog, so you should do short sessions to avoid burning them out or causing them to become distressed.
3. After your dog has had a break, repeat the exercise. If they're coming through with no hesitation, repeat the exercise holding the flap up only halfway. Your dog may be distressed by feeling the flap touching them, use lots of verbal encouragement to guide them through the door and reward them if they do go all the way through.
4. Once they're going through with the flap halfway up, continue doing short sessions with them, gradually lifting the flap up less and less, until your dog is pushing through the door on their own.
5. Now try to get them to do it on their own. You can do this by leaving them on one side of the door and scattering some treats or leaving their favourite toy on the other side of the door. Repeat this for a few sessions until your dog goes through without any verbal encouragement or reward.

WARRANTY CERTIFICATE

Congratulations! You have made an excellent choice of this quality product. Our commitment to quality also includes our service. Should you, contrary to expectations, experience defects due to manufacturing faults, we will provide you with a warranty against defects as follows:

WARRANTY

The product is guaranteed to be free from defects in workmanship and parts for a period of 3 years from the date of purchase. Defects that occur within this warranty period, under normal use and care, will be repaired, replaced or refunded at our discretion. The benefits conferred by this warranty are in addition to all rights and remedies in respect of the product that the consumer has under the Competition and Consumer Act 2010 and similar state and territory laws.

Our goods come with guarantees that cannot be excluded under the Australian Consumer Law. You are entitled to a replacement or refund for a major failure and for compensation for any other reasonably foreseeable loss or damage. You are also entitled to have the goods repaired or replaced if the goods fail to be of acceptable quality and the failure does not amount to a major failure.

PROOF OF PURCHASE

This warranty is valid for the original purchase and is not transferable. Please keep your purchase docket, tax invoice or receipt as the best proof of purchase, and as proof of date on which the purchase was made.

EXTENT OF WARRANTY

This warranty is limited to defects in workmanship or parts. All defective products or parts will be repaired or replaced. This warranty does not cover consumable items.

NORMAL WEAR AND TEAR

This warranty does not cover normal wear and tear to the products or parts.

EXCLUSIONS

This warranty does not cover:

- Any defects caused by an accident, misuse, abuse, improper installation or operation, lack of reasonable care, unauthorised modification, loss of parts, tampering or attempted repair by a person not authorised by the distributor.
- Any product that has not been installed, operated or maintained in accordance with the manufacturer's operating instructions provided with the product.
- Any product that has been used for purposes other than domestic use.

TO MAKE A CLAIM

If a defect in the goods appears within 3 years, you are entitled to claim a warranty.

Please contact after sales support via the link below:

www.hakunapets.com/contact-us

Please ensure that you have a copy of proof of purchase so that we are able to respond as quickly and efficiently as possible.

SPARE PARTS

Find Spare Parts for Super Tough Pet Door

Scan QR Code for spare parts info





Thankyou !

for making a purchase
with Hakuna Pets.

Providing our customers with a positive experience
is our #1 priority and we value your feedback.



If you have anything less than 5 star
satisfaction or you require any assistance
with spare parts please contact us directly at:
www.hakunapets.com/contact-us