

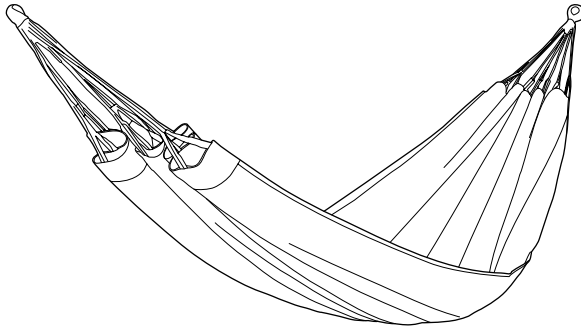

PRODUCT MANUAL

DOUBLE DELUXE COTTON PRINTED HAMMOCK

TT202D



200KG CAPACITY

HAMMOCK FABRIC SIZE: **160(W) x 220(L)**cm



WARNING

Read instructions before use and keep for future reference. Failure to read these instructions before use can lead to an increased risk of injury. When installing always check with a qualified builder for safety. Two Trees will only guarantee the performance of this product when used with other Two Trees products. i.e. if non Two Trees hammocks or stand are used, the guarantee is void.

Thank you for purchasing a Two Trees hammock.

We at Two Trees know the importance of spending time relaxing. Hence we've developed a range of quality hammocks and convenient accessories that come with easy to follow instructions so that you will be relaxing in no time. It is important to read all instructions before use and take care when using your hammock. Please ensure that you adhere to the following safety measures to get the maximum enjoyment from your new hammock.



WARNING

Read instructions before use and keep for future reference. Failure to read these instructions before use can lead to an increased risk of injury. When installing always check with a qualified builder for safety.

CAUTION AND SAFETY INSTRUCTIONS

1. Assembly must be carried out by an Adult.
2. Ensure hammock is fully assembled before use.
3. **DO NOT** exceed the maximum load of 200kgs.
4. **DO NOT** climb into hammock feet first.
5. **DO NOT** stand in hammock.
6. **DO NOT** dive into or jump about in hammock.
7. **DO NOT** stick your head through the suspension cords.
8. Keep suspension cords as straight as possible, **DO NOT** twist.
9. **DO NOT** use damaged or weakened hammock hanging accessories.
10. Hammock fabrics and accessories will wear over time and use. Always check the loading capacity and condition of parts before use.
11. Hammocks are not designed for swinging, playing, climbing or to be used as a children's toy.
12. **DO NOT** leave children or pets unattended in or near hammock.
13. Hammock fabric, suspension cords and hanging accessories will become worn over time and use. Always inspect prior to use and **DO NOT** use if items show signs of damage or weakness.
14. Always check the loading capacity before use.
15. Keep hammock clear of obstructions.
16. Allow a minimum of 50cm clearance range around the perimeter of your hammock when in use (Fig. 1).
17. Only use the hammock on level floors with shock-absorbing properties such as carpet or outdoor grass to minimise the risk of injury in case of an accident. **DO NOT** use on slippery or hard surfaces.
18. Never use a free standing brick wall to hang your hammock.
19. Only use Two Trees accessories for hanging your hammock.
20. **DO NOT** modify hammock. Hammock must be used in accordance of this manual.
21. **DO NOT** smoke in or around the hammock. Keep away from heat or flames.
22. **DO NOT** use whilst wearing shoes, clothing, jewellery or accessories that have a hook and loop fastener.
23. **DO NOT** use near sharp objects.
24. A copy of this manual must be provided should the hammock transfer ownership.

SELECTING THE LOCATION

There are many ways to hang your hammock, here are some of our favourite and recommended options:

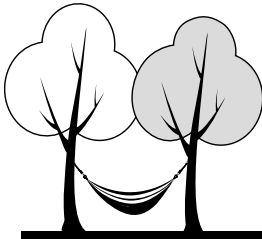
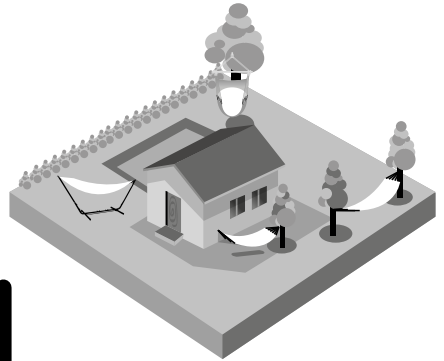

BETWEEN
TREES

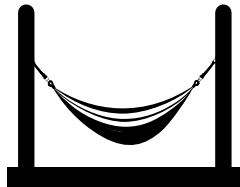

BETWEEN
TWO POSTS

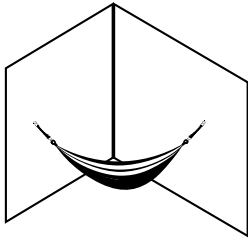

BETWEEN
TWO WALLS



ON HAMMOCK
STAND

THE TWO TREES HAMMOCKS RANGE INCLUDES





WARNING

Read instructions before use and keep for future reference. Failure to read these instructions before use can lead to an increased risk of injury. When installing always check with a qualified builder for safety.

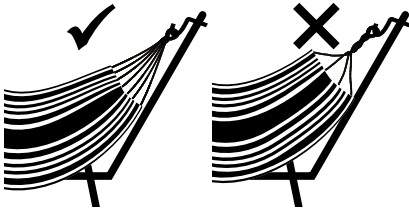

DO NOT twist or knot suspension cords when hanging.



Hammocks will stretch by 5-10% after the first few uses. Adjustments can be made after each use to keep you and your hammock comfortable.



DO NOT exceed the maximum load of 200kgs.



DO NOT leave children or pets unattended in or near hammock.

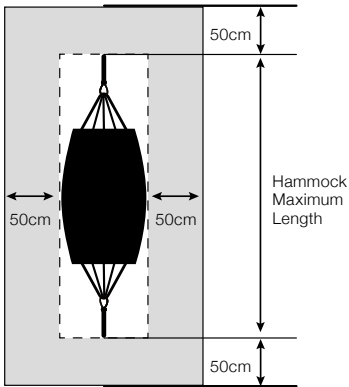

Allow a minimum of 50cm clearance range around the perimeter of your hammock when in use. <Fig.1>

You need a minimum of 3 metres between each anchor point to get the ideal shape. For longer distances, simply add a fixing strap or some rope and increase the height of the anchor point approximately 60cm for every additional metre in length.

Depending on the hammock the angle will vary. Conventional hammocks are hung with sag at approx. 110 degrees.

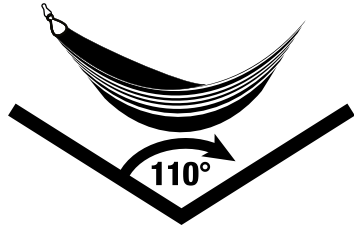

To hang your Two Trees hammock you will require two fixed points, such as trees, beams, posts, or dyna bolts into brick walls. Alternatively you can purchase a Two Trees Universal Stand. Consult a qualified builder if unsure.



WARNING: Never use a free standing brick wall to hang your hammock.

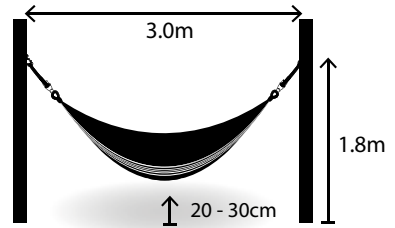

Your Two Trees hammock will require a minimum of 3 metres between fixing points to get the ideal shape. Rope may be needed to attach one end of the hammock, it is recommended to use a double piece to avoid the hammock twisting.

Hang the hammock loops at roughly the same height. When the hammock is in use it should sit 20-30cm above the ground.

TEMPORARY INSTALLATIONS

For temporary installations, such as trees or beams, we recommend using the Two Trees hammock hanging kit (TT501HK). For more information about our installation products please visit our website (www.twotreeshammocks.com.au)

- 1 Place the cord around the pole or tree, then thread through the figure eight hook.



- 2 Thread the cord through the clamp hook and secure at desired length.



- 3 Repeat process for other side of hammock. Ensure both hooks are secure, place hammock ends over hooks.



TEMPORARY INSTALLATIONS

For temporary installations that are portable and do not require a fixed point we recommend using the Two Trees Universal Stand (TT403UF).

- 1 Assemble and set up your universal stand according to the included instructions that were included with your Universal Stand.



- 2 Attach the hammock into the hooks at either end ensuring the hammock and suspension cords are not twisted.

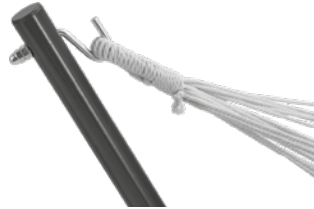

PERMANENT INSTALLATIONS

We recommend using the Two Trees screw eye and hook (TT502HH) with the Two Trees springs (TT503HS). The spring is optional.

NOTE: It is recommended to use structurally sound, strong timber posts that are 10cm square or more. When installing always check with a qualified builder for safety.

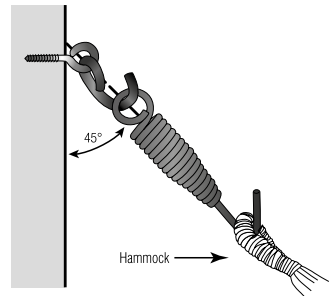
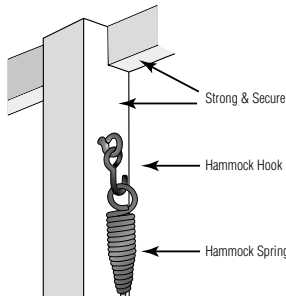

For sturdy masonry walls (not air/hollow/single brick or besser block) a 10mm dyna bolt with a large washer and rope can be used.

For detailed installation instructions on (TT503HS) Two Trees Spring, please refer to the Two Trees website.

www.twotreeshammocks.com.au or scan the below QR code.

 **WARNING:**
DO NOT EXCEED THE MAXIMUM LOAD OF 200KGS

Read instructions before use and keep for future reference. Failure to read these instructions before use can lead to an increased risk of injury. When installing always check with a qualified builder for safety.



HOW TO RELAX IN YOUR HAMMOCK

1



Open the hammock fabric in the centre of the hammock and slowly and safely sit in the middle as you would in a chair.

2



Gently lie back on a diagonal with your head on the edge of the hammock.

3



Bring your feet in and stretch them out, so you are lying on a diagonal. This is the traditional way to relax in a classic style hammock.

CARING FOR YOUR HAMMOCK

To prolong the the life of your hammock and stand it is best to store away when not in use, as the sun and rain will deteriorate the construction over time. If using near the sea it is important to rinse your hammock regularly.

Prior to washing your hammock, tie a loose single knot in the suspension cords at both hanger ends. Machine wash with cold water on a regular cycle using non-bleach detergent. **DO NOT** tumble dry. **DO NOT** iron. Dry in shade.

STORING YOUR HAMMOCK

When storing your Two Trees hammock make sure hammock is clean and completely dry.

To prevent tangles place a knot in each suspension cord. Fold the hammock in half, with suspension cords together. Then fold the edges of the hammock to the centre, and roll the hammock up starting with the suspension cords. Store in a dry place.

