



FULL BOAR

DIGITAL DRILL PRESS

- **POWERFUL 750W
INDUCTION MOTOR**
- **PRECISION SPEED
CONTROL**
- **EASY SPEED
ADJUSTMENT**



INSTRUCTION MANUAL



WARNING: Read all safety warnings and all instructions. Failure to follow the warnings and instructions may result in electric shock, fire and/or serious injury. Save all warnings and instructions for future reference.

SPECIFICATIONS - MODEL NO. FBDDP-7500

Voltage:	220 – 240V ~ 50Hz
Motor rating:	750 W (S2 15min)
Motor speed:	1480/min
Output speed:	450 – 2,500/min
Drill chuck mount:	B 16
Spindle taper:	MT2
Drill chuck:	Ø 1 – 16 mm
Throat:	152 mm
Dimensions of table:	243 x 243 mm
Angle adjustment of table:	45° / 0° / 45°
Drill depth:	80 mm
Column diameter:	65 mm
Height:	955 mm
Base area:	456 x 304 mm
Weight (tool only):	40.6 kg

KNOW YOUR PRODUCT

1. Main housing
2. Speed control lever
3. Column
4. V-belt cover
5. Rail
6. Safety guard bracket
7. Rail screw
8. Safety guard
9. Guard screw
10. Digital display
11. ON switch
12. OFF switch
13. Emergency stop button
14. On/Off switch for LED worklight
15. Spindle
16. Drill chuck
17. Feed handle
18. Drill table
19. Roller support
20. Table lock
21. Mounting holes x 4
22. V-belt cover
23. Motor
24. Depth stop lock knob
25. Locking ring
26. Gear rack
27. Table height adjustment handle
28. Table Support
29. Bolts, washers and spring washers x 4
30. Base
31. Screw for safety guard x 2
32. Screw and washer for rail
33. Arbor MT2
34. Drift key
35. Hex key x 5

KNOW YOUR PRODUCT (cont.)

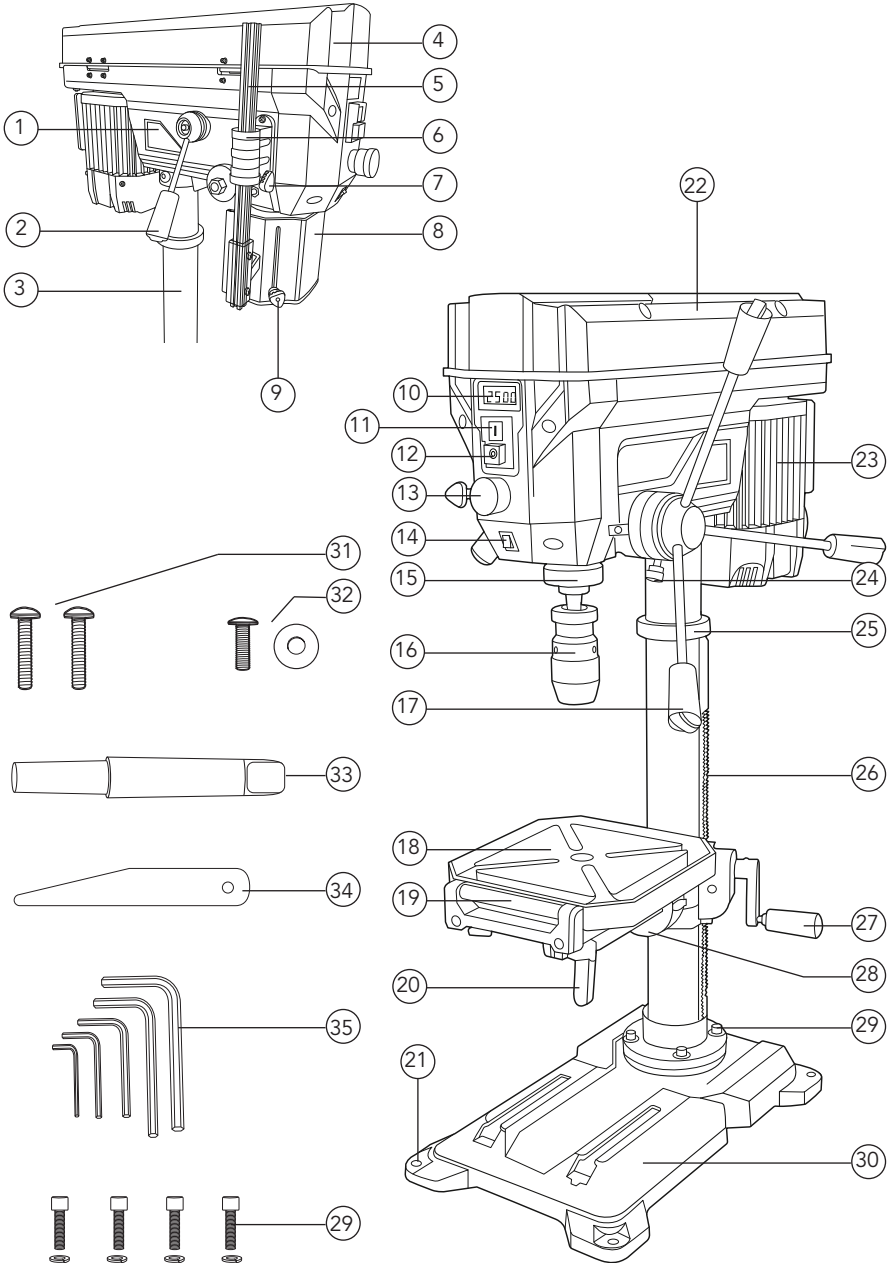

TABLE OF CONTENTS

SPECIFICATIONS.....	Page 02
KNOW YOUR PRODUCT.....	Page 02
INTRODUCTION.....	Page 05
SAFETY INSTRUCTIONS.....	Page 05
ASSEMBLY.....	Page 10
ADJUSTMENTS.....	Page 15
OPERATION.....	Page 20
MAINTENANCE.....	Page 22
TROUBLE SHOOTING.....	Page 24
DESCRIPTION OF SYMBOLS.....	Page 26
CONTENTS.....	Page 27
WARRANTY.....	Page 28

INTRODUCTION

Congratulations on purchasing a Full Boar Digital Bench Drill Press.

Your Full Boar Digital Drill Press FBDDP-750 is designed for drilling large or small holes in metal, plastic, wood and similar materials. Heavy duty cast iron base and table provide solid and stable work surface.

SAFETY INSTRUCTIONS



WARNING! When using mains-powered equipment, basic safety precautions, including the following, should always be followed to reduce risk of fire, electric shock, personal injury and material damage.

Read and understand the manual prior to operating this tool.

Save these instructions and other documents supplied with this tool for future reference.

ELECTRICAL SAFETY

The electric motor has been designed for 220V and 240V only. Always check that the power supply corresponds to the voltage on the rating plate.

Note: The supply of 230V and 240V on Ozito tools are interchangeable for Australia and New Zealand.

If the supply cord is damaged, it must be replaced by an electrician or a power tool repairer in order to avoid a hazard.

Using an Extension Lead

Always use an approved extension lead suitable for the power input of this tool. Before use, inspect the extension lead for signs of damage, wear and ageing. Replace the extension lead if damaged or defective. When using an extension lead on a reel, always unwind the lead completely. Use of an extension lead not suitable for the power input of the tool or which is damaged or defective may result in a risk of fire and electric shock.

GENERAL SAFETY INSTRUCTIONS



WARNING! Read all instructions. Failure to follow all instructions listed below may result in electric shock, fire and/or serious injury. The term "Power Tool" in all of the warnings listed below refers to your mains operated (corded) power tool or battery operated (cordless) power tool.

SAVE THESE INSTRUCTIONS

1. Work area safety

- a. **Keep work area clean and well lit.** Cluttered or dark areas invite accidents.
- b. **Do not operate power tools in explosive atmospheres, such as in the presence of flammable liquids, gases or dust.** Power tools create sparks which may ignite the dust or fumes.
- c. **Keep children and bystanders away while operating a power tool.** Distractions can cause you to lose control.

2. Electrical safety

- a. **Power tool plugs must match the outlet. Never modify the plug in any way. Do not use any adapter plugs with earthed (grounded) power tools.** Unmodified plugs and matching outlets will reduce risk of electric shock.
- b. **Avoid body contact with earthed or grounded surfaces, such as pipes, radiators, ranges and refrigerators.** There is an increased risk of electric shock if your body is earthed or grounded.
- c. **Do not expose power tools to rain or wet conditions.** Water entering a power tool will increase the risk of electric shock.
- d. **Do not abuse the cord. Never use the cord for carrying, pulling or unplugging the power tool. Keep cord away from heat, oil, sharp edges or moving parts.** Damaged or entangled cords increase the risk of electric shock.
- e. **When operating a power tool outdoors, use an extension cord suitable for outdoor use.** Use of a cord suitable for outdoor use reduces the risk of electric shock.
- f. **If operating a power tool in a damp location is unavoidable, use a residual current device (RCD) protected supply.** Use of an RCD reduces the risk of electric shock.

3. Personal safety

- a. **Stay alert, watch what you are doing and use common sense when operating a power tool. Do not use a power tool while you are tired or under the influence of drugs, alcohol or medication.** A moment of inattention while operating power tools may result in serious personal injury.
- b. **Use personal protective equipment. Always wear eye protection.** Protective equipment such as dust mask, non-skid safety shoes, hard hat, or hearing protection used for appropriate conditions will reduce personal injuries.
- c. **Prevent unintentional starting. Ensure the switch is in the off-position before connecting to power source and/or battery pack, picking up or carrying the tool.** Carrying power tools with your finger on the switch or energising power tools that have the switch on invites accidents.

GENERAL SAFETY INSTRUCTIONS (cont.)

- d. **Remove any adjusting key or wrench before turning the power tool on.** A wrench or a key left attached to a rotating part of the power tool may result in personal injury.
 - e. **Do not overreach. Keep proper footing and balance at all times.** This enables better control of the power tool in unexpected situations.
 - f. **Dress properly. Do not wear loose clothing or jewellery. Keep your hair, clothing and gloves away from moving parts.** Loose clothes, jewellery or long hair can be caught in moving parts.
 - g. **If devices are provided for the connection of dust extraction and collection facilities, ensure these are connected and properly used.** Use of dust collection can reduce dust-related hazards.
 - h. **Do not let familiarity gained from frequent use of tools allow you to become complacent and ignore tool safety principles.** A careless action can cause severe injury within a fraction of a second.
- 4. Power tool use and care**
- a. **Do not force the power tool. Use the correct power tool for your application.** The correct power tool will do the job better and safer at the rate for which it was designed.
 - b. **Do not use the power tool if the switch does not turn it on and off.** Any power tool that cannot be controlled with the switch is dangerous and must be repaired.
 - c. **Disconnect the plug from the power source and/or the battery pack from the power tool before making any adjustments, changing accessories, or storing power tools.** Such preventive safety measures reduce the risk of starting the power tool accidentally.
 - d. **Store idle power tools out of the reach of children and do not allow persons unfamiliar with the power tool or these instructions to operate the power tool.** Power tools are dangerous in the hands of untrained users.
 - e. **Maintain power tools. Check for misalignment or binding of moving parts, breakage of parts and any other condition that may affect the power tool's operation. If damaged, have the power tool repaired before use.** Many accidents are caused by poorly maintained power tools.
 - f. **Keep cutting tools sharp and clean.** Properly maintained cutting tools with sharp cutting edges are less likely to bind and are easier to control.
 - g. **Use the power tool, accessories and tool bits etc. in accordance with these instructions, taking into account the working conditions and the work to be performed.** Use of the power tool for operations different from those intended could result in a hazardous situation.
 - h. **Keep handles and grasping surfaces dry, clean and free from oil and grease.** Slippery handles and grasping surfaces do not allow for safe handling and control of the tool in unexpected situations.
- 5. Service**
- a. **Have your power tool serviced by a qualified repair person using only identical replacement parts.** This will ensure that the safety of the power tool is maintained.
 - b. **If the supply cord is damaged,** it must be replaced by the manufacturer, its service agent or similarly qualified persons in order to avoid a hazard.

ADDITIONAL SAFETY RULES FOR BENCH DRILLS



IMPORTANT! When using the equipment, a few safety precautions must be observed to avoid injuries and damage. Please read the complete operating manual with due care. Keep this manual in a safe place so that the information is available at all times. If you give the equipment to any other person, give them these operating instructions as well.

We cannot accept any liability for damage or accidents which arise due to a failure to follow these instructions and the safety information.



WARNING! Using any plug-in tools and accessories other than those specified in these operating instructions can lead to injury.

1. The bench drill was designed in such a way so as to all but eliminate potential hazards when the machine is properly used. However, there are a few safety precautions to observe in order to ensure that all residual hazards are ruled out.
2. **Ensure proper voltage.** The voltage must comply with the specifications on the rating plate.
3. **Protection against electrical shock:** Keep the device away from moisture. The device must neither be damp nor be operated in a humid environment. Prior to every use, check the device and the mains cable with plug for damage. Avoid bodily contact with earthed parts e.g. pipes, hot elements, etc.
4. **Protection against fire and explosion:** There are spark producing components inside the device. Do not use the device in the vicinity of combustible liquids or gases. Otherwise there is a risk of fire or explosion.
5. **Handle the device with care:** Do not use the cable to pull the plug out of the socket. Protect the cable from heat, oil and sharp edges. Keep your tools sharp and clean so that you can work efficiently and safely. Follow the maintenance regulations and the instructions for changing tools.
6. **Wear suitable work clothes and personal protection equipment:** Loose clothing is not suitable, as it can be caught by moving parts, causing you to become entangled. Wear a hair net if you have long hair. As a general rule, jewellery should not be worn when working with machine tools. Ensure that you wear safety goggles. Not doing so could result in eye injury.
7. **Store the tools in a safe location:** Store unused devices in a dry, locked location that is out of the reach of children.
8. **Avoid overloading the device:** Operate the device only within the specified output range. Do not use any low-powered machines for heavy duty work. Do not use tools to perform work for which they were not intended.
9. **Maintain a steady foothold:** Ensure that you maintain a steady foothold while working. Avoid abnormal body positions and always keep your balance.
10. **Pull out the mains plug:** Pull out the mains plug when not using the tool, prior to maintenance, and when changing the drill bit.

ADDITIONAL SAFETY RULES FOR BENCH DRILLS

11. **Avoid unintentional start-up:** Ensure that switch is turned off when plugging the plug into the socket.
12. **Keep an eye on your work:** Always keep an eye on your machine and the object you are working on. Never use the machine when you are not concentrating or are distracted. Never use the machine when you are under the influence of alcohol or are taking medication.
13. **Check the tool for damage:** Before using the tool, safety devices and any slightly damaged parts must be carefully checked to ensure that they are in good working order. Visually examine the tool's power cable on a regular basis. All parts must be correctly assembled and meet all the conditions required to ensure proper operation. Unless otherwise specified in the operating instructions, any damaged safety devices and parts must be properly repaired or replaced by a professionally recognized workshop. Never use tools with defective On/Off switches.
14. Your bench drill must be bolted securely to a workbench.
15. This bench drill is intended for use in dry conditions and indoor use only.
16. **Do not try to drill material too small to be securely held.** Do not drill material that does not have a flat surface unless it is clamped securely.
17. **Always keep hands out of the path of the drill bit.** Avoid awkward hand positions where a sudden slip could cause your hand to move into the drill bit.
18. Do not use wire wheels, router bits, shaper cutters, circle cutters or rotary planers on this bench drill.
19. **Always hold the workpiece firmly against the table so it will not move.** Use clamps or a vice for unstable workpieces.
20. **Do not exceed the rpm stated on the bit or accessory.** See the instructions that come with the accessory. Set the bench drill to a speed appropriate to the job.
21. Make sure there are no nails or foreign objects in the part of the workpiece to be drilled.
22. Do not start the bench drill while the drill bit is touching the workpiece.
23. **Make sure all clamps and locks are firmly tightened before drilling.** Securely lock the head and table support to the column, and the table to the table support before operating your bench drill.
24. Never turn your bench drill on before clearing the table of all objects (tools, scraps of wood etc.)
25. Let the spindle reach full speed before starting to drill.
26. When drilling large diameter holes, clamp the workpiece firmly to the table. Otherwise, the bit may grab and spin the workpiece at high speed.
27. Make sure the spindle has come to a complete stop before touching the workpiece.
28. **Always wear safety goggles which comply to a recognised standard.** Use a face or dust mask along with safety goggles if the drilling operation is dusty. Use ear protectors, especially during extended periods of operation.
29. When drilling metals it is recommended to use lubricants to prolong accessories.
30. Ensure drill bit has cooled before touching as it may be hot. Always wear gloves.

ASSEMBLY



WARNING! During assembly ensure the bench drill is disconnected from the power supply.



WARNING! Some parts are heavy, two-person lift may be required to avoid injury.

Assembling the digital drill press

1. Carefully remove contents from the packaging.
2. Select a firm, level surface on which to assemble the bench drill.
3. Securely fasten the column (3) to the base using the 4 supplied bolts, washers and spring washers (29) (Fig. 1).

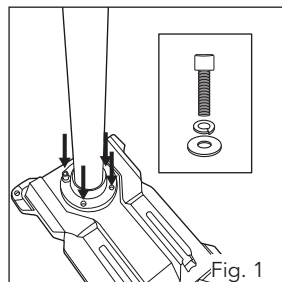

4. Install the gear rack (26) into the stable support (28) as shown (Fig. 2).

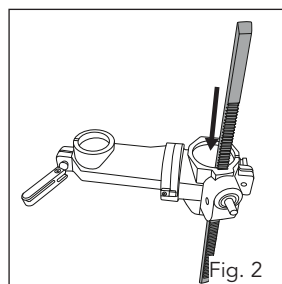

5. Hold the gear rack (26) in position while sliding the table support (28) onto the column (3), ensuring the rack is positioned on the right side of the column (when viewing the product from the front) (Fig. 3).

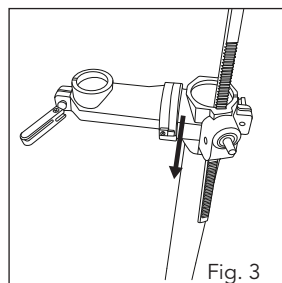

ASSEMBLY (cont.)

6. Slide the gear rack (26) all the way down until it locates into the base of the column (3) (Fig. 4).

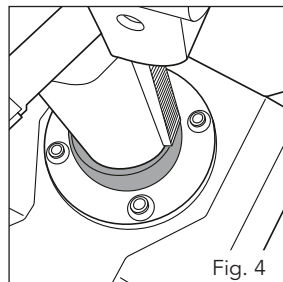

7. Slide the locking ring (25), tapered side facing down so that it rests lightly on the gear rack (26). Tighten the fitted grub screw to secure locking ring (25) in position with hex key. (Fig. 5)

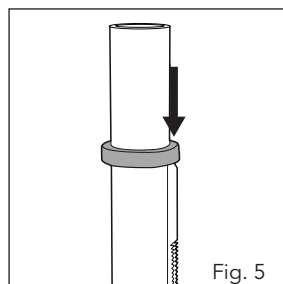

8. Fix table height adjustment handle (27) on table support (28) (Fig. 6).

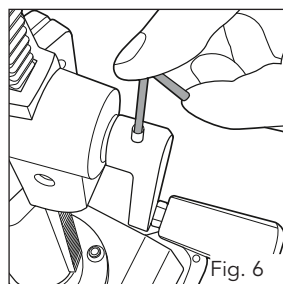

9. Assemble drill table (18) onto table support (28), tighten in place with table lock (20) (Fig. 7).

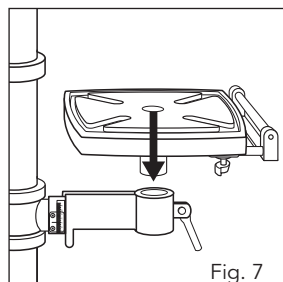

ASSEMBLY (cont.)

10. Fit the main Housing (1) to the column (3). Align the head so that it is horizontal to the base (Fig. 8).

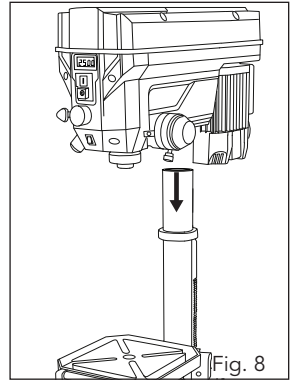

11. Fasten the main Housing (1) in position by tightening the 2 fitted grub screws on both sides (Fig. 9), with hex key.

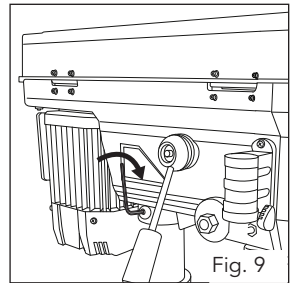

12. Screw the 3 feed handles (17) into the threaded handle mount (Fig. 10).

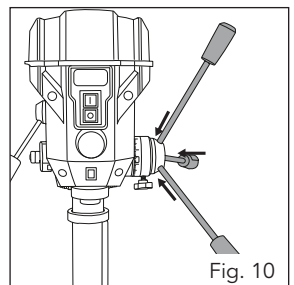

ASSEMBLY (cont.)

13. Force the arbor (33) into the top of the drill chuck (16) by hand, using reasonable force (Fig. 11).

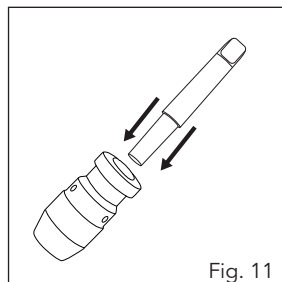

IMPORTANT: Before you mount the drill chuck onto the spindle, check that both parts are free of dirt and grease. This ensures optimal transmission of power.

14. The arbor (33) can then be inserted into the spindle (15), twisting the arbor as you insert (Fig. 12). Guide it in until it stops. Turn the chuck until it slips a little further into the spindle. Now force the drill chuck upwards (a firm tap on the underside of the chuck with a soft face hammer can be used) and check that it is secure.

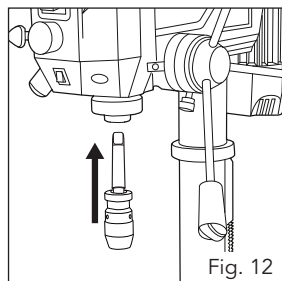

15. Assemble the rail (5) to the safety guard (8). Secure the rail to the safety guard using the two screws (31) (Fig. 13).
16. Push rail (5) into the safety guard bracket (6) (Fig. 14). Ensure the groove on the rail (5) aligns with the groove in the safety guard bracket (6).
17. Fit screw and washer (32) to rail (5) (Fig. 15).



IMPORTANT: The safety guard (8) is equipped with a microswitch. This prevents the digital drill press from operating if the safety guard is open. To ensure that it functions correctly, the safety guard (8) must be fitted in the "closed" position.

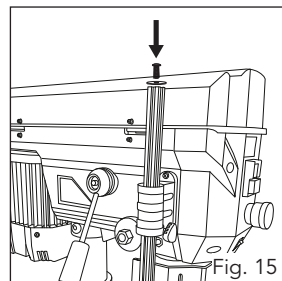
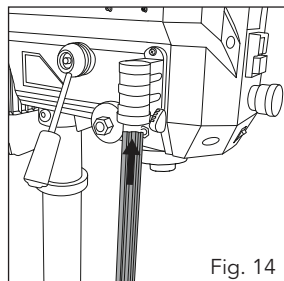
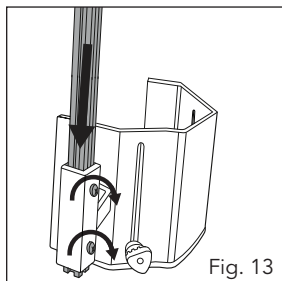

ASSEMBLY (cont.)

18. Before you use the digital drill press for the first time it must be mounted in a stationary position on a firm surface. Use four mounting holes (21) in the base (30) to do this. Ensure that the machine is freely accessible for operation, adjustment and maintenance (Fig. 16).

Note: Mounting screws not supplied.

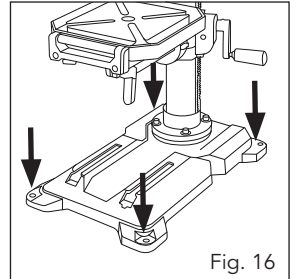

Fig. 16



IMPORTANT: The fixing screws may only be tightened to a point where they do not distort or deform the base (30). Excessive tension can lead to fracture.

ADJUSTMENTS

Table height adjustment

1. Loosen the table support lock (Fig. 17).
2. Rotate the table adjustment handle (27) to set the desired drill table (18) height. Tighten the table lock to secure the drill table (18) in position (Fig. 18).

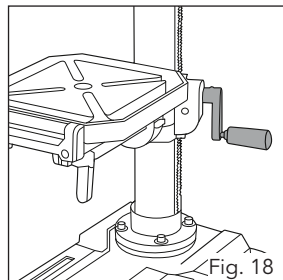
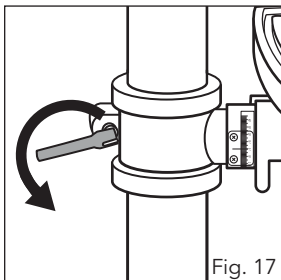
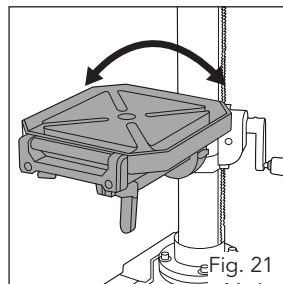
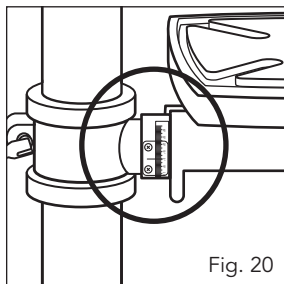
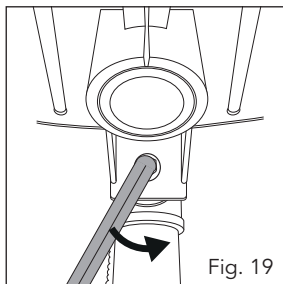

Table bevel adjustment



WARNING! Before adjusting the angle, ensure the table lock (10) is tightened.

1. The bevel angle is adjusted by loosening the socket screw that is located underneath the table support (28) with supplied hex key (35) (Fig. 19).
2. With the aid of the angle scale (Fig. 20), set the drill table (18) to the desired angle (Fig. 21).
3. Re-tighten the socket screw in order to lock the drill table (18) into its position.



Rotating table adjustment

1. Loosen the table lock (10) to rotate the drill table (18) to the left or right (Fig. 22).
2. Re-tighten table lock (10) when the drill table (18) is in the desired position.

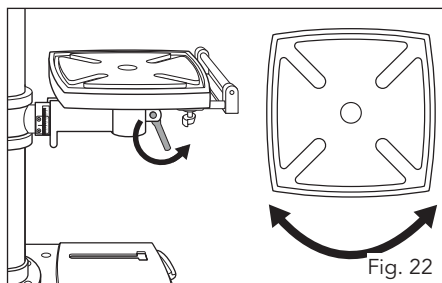

ADJUSTMENTS (cont.)

Roller support adjustment

1. Loosen the thumb screws to extend the roller support (19).
2. Re-tighten thumb screw when the roller support (19) is in the desired position (Fig. 23).



WARNING! Use a suitable clamping device to secure a workpiece in position. Never hold the workpiece in place with your hand! Ensure that the workpiece cannot rotate.

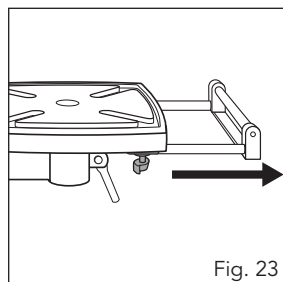

Fig. 23

Safety guard adjustment

1. By loosening the rail screw (7) the height of the safety guard (8) is infinitely adjustable. The safety guard can also be flipped to the side, exposing the chuck and enabling bits to be changed. (Fig. 24).



IMPORTANT! The safety guard (8) is equipped with a microswitch. This prevents the machine starting up if the safety guard is in the open position. To ensure that it functions correctly, the safety guard (8) must be in the "closed" position (Fig. 24).

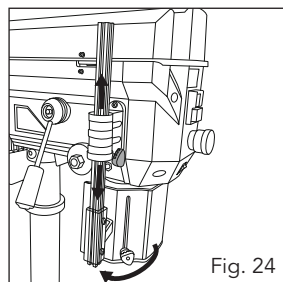

Fig. 24

2. The length of the safety guard is adjustable and can be locked in position using the guard screws (9) on either side (Fig. 25).

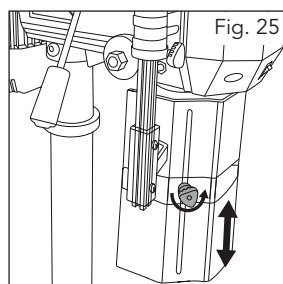

Fig. 25

ADJUSTMENTS (cont.)

Installing straight shank drill bit



WARNING! Always ensure the digital drill press is switched off and disconnected from the power supply before installing/changing drill bits.

1. Make sure that the power plug is removed from the socket-outlet before changing bits.



WARNING! Only cylindrical bits with the stipulated maximum shaft diameter may be clamped in the drill chuck (9) (Fig. 26).



∅ 1 - 16mm

Fig. 26



WARNING! Only use a bit that is sharp and free of defects. Do not use bits whose shaft is damaged or which are deformed or flawed in any other way.



WARNING! Use only accessories and attachments that are specified in the operating instructions or have been approved by the manufacturer. If the bench drill should become jammed, switch off the machine and return the drill to its starting position.

2. Your digital drill press is equipped with a keyless chuck. This enables tools to be changed without the need for an additional chuck key. To do so, insert the tool in the drill chuck (16) and tighten by hand (Fig. 27).

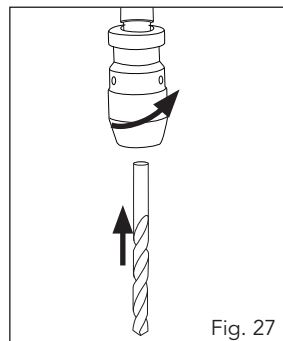

Fig. 27



WARNING! Do not open V-belt cover (22) when in use. Changing speed is controlled by external speed control lever (2) and no access to the V-belt is required.

ADJUSTMENTS (cont.)

Presetting the drilling depth

The drilling spindle has a swivelling scale ring for setting the drill depth. Only adjust the setting when the machine is at a standstill. Make sure that the power plug is removed from the socket-outlet before adjusting the setting.

To stop spindle (and bit) at a desired depth:-

1. Loosen depth stop lock knob (24) by turning in an anti-clockwise direction (Fig. 28).
2. Rotate depth scale to the desired depth, then re-tighten knob (24) (Fig. 29).

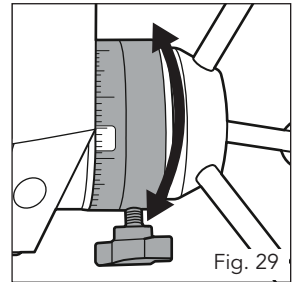
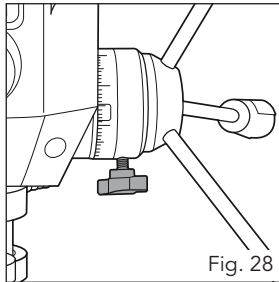

To hold the spindle (and bit) at a desired depth:-

1. Loosen depth stop lock knob (24), Turn feed handle (17) to lowest point (Fig. 30)
2. Rotate depth scale to desired depth and re-tighten depth stop lock knob (24). This will hold assembly stationary at desired depth.

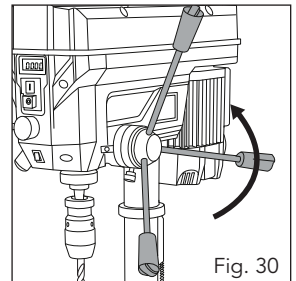

Morse taper drill bits - MT2

To use Morse taper drill bits, remove chuck (16) and arbor (33)

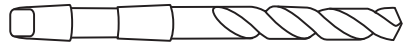

1. Move the drill chuck (16) to the lower position.
2. Lock the spindle (15) in the lowered position using the depth scale to maximize access to the drill chuck (16)
3. Turn arbor (33) until the tang aligns with the slot in the spindle (15) (Fig. 31).

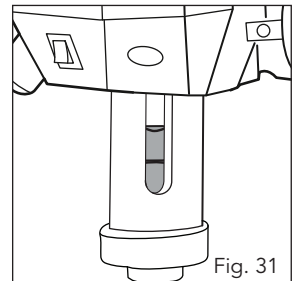

ADJUSTMENTS (cont.)

4. Insert the drift key (34) into the slot and tap firmly with a soft face hammer until it releases, taking care as you do so to ensure that the chuck does not land on the floor. (Ensure the chuck jaws are wound all the way up to prevent damage) (Fig. 32).

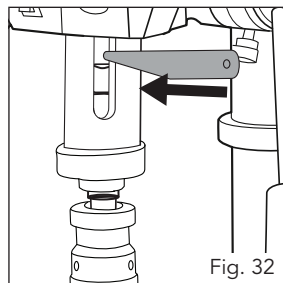

5. Place tapered bit into the spindle hole, twisting and pushing upward until bit is snug (Fig. 33).
6. Place block of wood on the drill table (18) and raise up table until the tapered bit is firmly into the spindle.

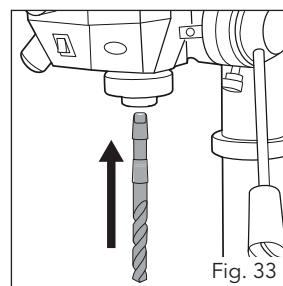

Setting the speed

The operating speed of the machine is infinitely adjustable.

1. Slowly and steadily move the speed control lever (2) while the machine is in idle mode (Fig. 34).

Pull the lever (2) towards the front for higher speeds or push away for a slower speed.



IMPORTANT! Speed adjustments are allowed only when the motor is running.

2. The set speed is shown on the digital display (16) in revolutions per minute (Fig. 35).

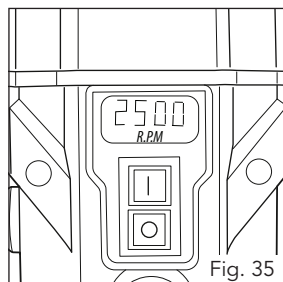
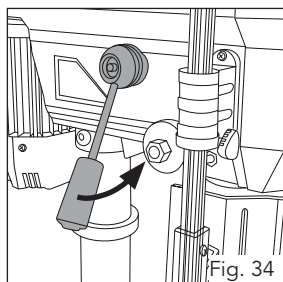

OPERATION



WARNING! The power supply for this product should be protected by a residual current device (rated at 30mA or less). A residual current device reduces the risk of electric shock.

The bench drill is equipped with a no-volt trip that is designed to protect the operator from an undesired restart following a power outage. Should this occur, the machine must be manually restarted.

Switching on and off

1. To switch on the machine, push in the green On button "I" (11); the machine starts up (Fig. 36).
2. To switch off, press the red Off button "O" (12); the device shuts down (Fig. 36).

Note. Ensure that you do not overload the device. If the sound of the motor drops in pitch during operation, it is being overloaded.

Do not overload the device to the point where the motor comes to a standstill. Always stand in front of the machine during operation.

Note. Pressing the Emergency Stop button (13) enables the machine to be brought to an immediate standstill in an emergency.

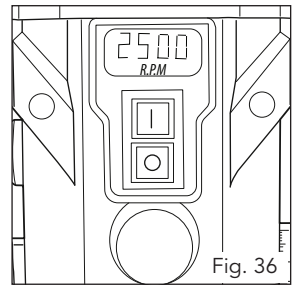

Fig. 36

LED worklight

The drill table (18) is equipped with an LED worklight for illuminating the work area. This can be switched On and OFF by the switch (14)

Drilling wood

Please note that sawdust must be properly extracted when working with wood, as it can pose a health hazard. Ensure that you wear a suitable dust mask when performing work that generates dust.



WARNING! Please note that sawdust must be properly extracted when working with wood, as it can pose a health hazard. Ensure that you wear a suitable dust mask when performing work that generates dust.

OPERATION (cont.)

Working speed table

Ensure that you drill at the proper speed. Drill speed is dependent on the diameter of the drill bit and the material in question.

The table below acts as a guide only for selecting the proper speed for various materials.

Note: The drill speeds specified are a guide only.

Drill bit Ø	Cast iron	Steel	Iron	Aluminium	Bronze
3mm	2550	1600	2230	-	-
4mm	1900	1200	1680	-	-
5mm	1530	955	1340	-	-
6mm	1270	800	1100	-	-
7mm	1090	680	960	-	-
8mm	960	600	840	-	-
9mm	850	530	740	-	-
10mm	765	480	670	-	2400
11mm	700	-	610	-	2170
12mm	640	-	560	2400	2000
13mm	590	-	515	2200	1840
14mm	545	-	480	2000	1700
16mm	480	-	-	1800	1500

Note: All drill speed values are in RPM to match the digital display.

Countersinking and centre-drilling

With this working speed table, you can also countersink and center-drill. Please observe that countersinking should be performed at the lowest speed, while a high speed is required for center-drilling.

MAINTENANCE



WARNING! Ensure the drill press is switched off and disconnected from the power supply before performing any maintenance or cleaning.

- Ball bearings are packed with grease at the factory. No further lubrication of bearings is required.
- Lubricate all moving parts periodically. Wipe the column, table and base with an oily cloth to minimise corrosion.
- Keep air vents clean of dust and dirt.
- Remove dust and dirt from the drill press regularly with a soft cloth, brush or compressed air.
- If the power cord is damaged, have it replaced by an electrician or a qualified power tool repairer.
- Regularly check that all bolts, screws and nuts are securely fixed as these could work loose during normal operation.

Note: Ozito Industries will not be responsible for any damage or injuries caused by the repair of the drill press by an unauthorised person or by mishandling of the pedestal drill.

Changing the V-belt



IMPORTANT! Never let the bench drill run when the V-belt cover is open. Always pull out the power plug before opening the cover. Never touch the V-belt when it is rotating.

The V-belt of the bench drill is a consumable part and should be replaced when worn. Replace the V-belt as follows:

1. Run the machine while slowly setting the speed control lever (2) to the minimum speed.
2. Switch the machine off, then pull out the power plug.
3. Set the speed control lever (2) to the maximum speed setting to slacken the V-belt (Fig. 37).
4. Undo the screws to open the V-belt cover (22) (Fig. 38).

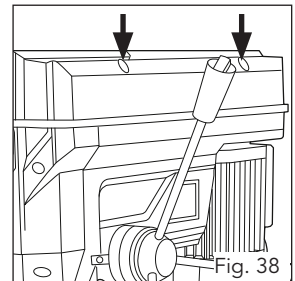
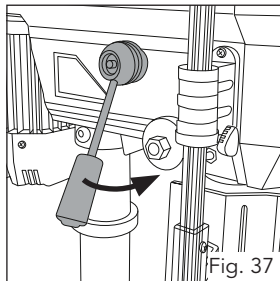

MAINTENANCE (cont.)

5. Pry the V-belt off of the smaller drive pulley by pulling up the belt on one side and slowly turning the pulleys (Fig. 39).

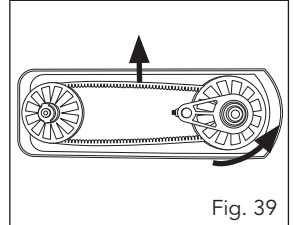

6. The drive pulley comprises two disks that are pressed together via a spring. If the V-belt does not exhibit enough play to remove it, gently press the bottom half of the drive pulley down to slacken the V-belt (Fig. 40).

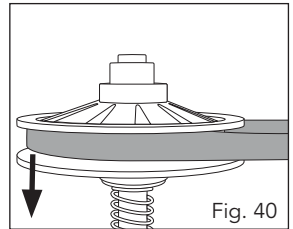

IMPORTANT! When replacing the V-belt, always use the correct belt type.

7. Fit one end of the new V-belt to the variable pulley. Fit the other end to the drive pulley by first sliding it into the groove on one side of the drive pulley, then prying the V-belt across the pulley into the groove on the other side (Fig. 41). Pressing down on the bottom disc of the drive pulley will give the V-belt additional slack.
8. Close the V-belt cover (22) and screw down using the cover screws.

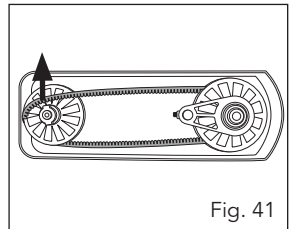

TROUBLE SHOOTING





Problem	Cause	Solution
Drill press will not start.	Power cord not connected to the mains power supply.	Ensure that the power cord is connected to the mains power.
	Power fault.	Check the mains power supply.
	Safety guard (8) not fitted or in the open position.	Fit and place safety guard (8) in the "closed" position.
	Power cord damage.	Use an electrician or a power tool repairer to repair or replace.
	Faulty switch or motor.	Use an electrician or a power tool repairer to repair or replace.
	V-belt cover (22) not secured.	Check the V-belt cover (22) is closed and lowered correctly in position.
Drill bit burns.	Incorrect speed.	Adjust speed as described in the "Setting the speed" section (Page 19) and "Working speed table" (Page 21).
Excessive drill bit wobble.	Bent or damaged drill bit.	Use a new drill bit.
	Drill bit is not securely placed in the 16mm drill chuck (16).	Remove the drill bit and reinsert correctly, ensure the chuck jaws are fully tightened.
	The 16mm drill chuck (16) is not installed correctly.	Ensure you install the 16mm drill chuck (16) correctly.
Drill bit binds in workpiece.	Belt tension is set incorrectly.	Re-adjust the V-belt tension.

NOTES



A series of horizontal lines for writing, starting from the top right of the page and extending downwards. The lines are evenly spaced and cover most of the page's width.

DESCRIPTION OF SYMBOLS

V	Volts	Hz	Hertz
~	Alternating current	W	Watts
/min	Revolutions or reciprocation per minute	n_o	No load speed
	Read instruction manual		Regulator compliance mark
	Wear eye and ear protection		Warning

CARING FOR THE ENVIRONMENT



Power tools that are no longer usable should not be disposed of with household waste but in an environmentally friendly way. Please recycle where facilities exist. Check with your local council authority for recycling advice.



Recycling packaging reduces the need for landfill and raw materials. Reuse of recycled material decreases pollution in the environment. Please recycle packaging where facilities exist. Check with your local council authority for recycling advice.

CONTENTS

1x Main Housing
1x Column
1x Drill table & roller support
1x Base
1x Table support
3x Feed handles
1x Safety guard
1x Rail
1x Drill chuck
1x Table adjustment handle
4x Bolt, washer & spring washer
2x Safety guard screws
1x Screw & washer for rail
5x Hex keys
1x Drift key
1x Arbor

Distributed by:

Ozito Industries Pty Ltd

AUSTRALIA (Head Office)

1-23 Letcon Drive, Bangholme Victoria, Australia, 3175

Telephone: 1800 069 486

WARRANTY

YOUR WARRANTY FORM SHOULD BE RETAINED BY YOU AT ALL TIMES. IN ORDER TO MAKE A CLAIM UNDER THIS WARRANTY YOU MUST RETURN THE PRODUCT TO YOUR NEAREST BUNNINGS WAREHOUSE (see www.bunnings.com.au or www.bunnings.co.nz for store locations) WITH YOUR BUNNINGS REGISTER RECEIPT. PRIOR TO RETURNING YOUR PRODUCT FOR WARRANTY PLEASE TELEPHONE OUR CUSTOMER SERVICE HELPLINE:

**Australia 1800 069 486
New Zealand 0508 069 486**

TO ENSURE A SPEEDY RESPONSE PLEASE HAVE THE MODEL NUMBER AND DATE OF PURCHASE AVAILABLE. A CUSTOMER SERVICE REPRESENTATIVE WILL TAKE YOUR CALL AND ANSWER ANY QUESTIONS YOU MAY HAVE RELATING TO THE WARRANTY POLICY OR PROCEDURE.

1 YEAR WARRANTY

Your product is guaranteed for a period of **12 months from the original date of purchase**. If a product is defective it will be replaced in accordance with the terms of this warranty. Warranty excludes consumable parts, for example: wheels, bearings.

The benefits provided under this warranty are in addition to other rights and remedies which are available to you under law. The warranty covers manufacturer defects in materials, workmanship and finish under normal use.

Our goods come with guarantees that cannot be excluded under Australian Consumer law & Consumer Guarantees Act 1993 (NZ). You are entitled to a replacement or refund for a major failure and to compensation for other reasonably foreseeable loss or damage. You are also entitled to have the goods repaired and replaced if the goods fail to be of acceptable quality and the failure does not amount to a major failure.

WARRANTY EXCLUSIONS

The following actions will result in the warranty being void.

- If the tool has been operated on a supply voltage other than that specified on the tool.
- If the tool shows signs of damage or defects caused by or resulting from abuse, accidents or alterations.
- Failure to perform maintenance as set out within the instruction manual.
- If the tool is disassembled or tampered with in any way.
- The warranty excludes damage resulting from product misuse or product neglect.

This warranty is given by Ozito Industries Pty Ltd.

ABN: 17 050 731 756

Ph.1800 069 486

Australia/New Zealand (Head Office)

1-23 Letcon Drive, Bangholme, Victoria, Australia 3175