

# ozito

## PENDULUM JIGSAW

**680W**

### INSTRUCTION MANUAL

#### SPECIFICATIONS

Input Power:	230-240V~50Hz
Motor:	680W
No Load Speed	800-3,100/min
Stroke Depth:	19mm
Bevel:	+/- 45°
Blade Fitment:	Bayonet
Cutting Capacities:	Timber 65mm Plastic 12mm Mild Steel 6mm
Weight:	2.13kg

[ozito.com.au](http://ozito.com.au)

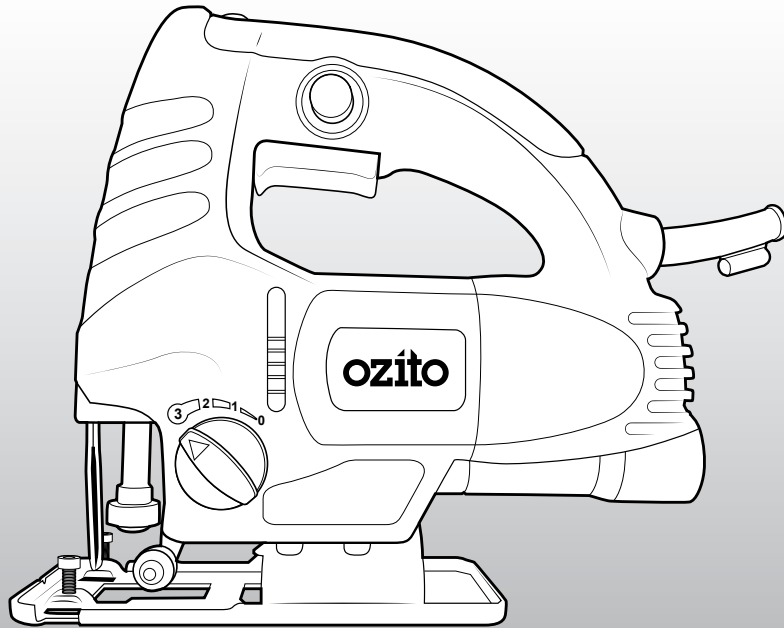

#### WHAT'S IN THE BOX

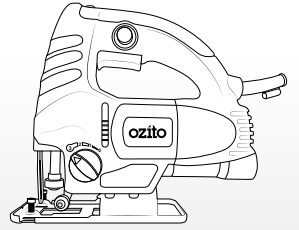

Jigsaw

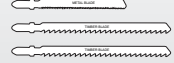

3 x Cutting Blades



Parallel Guide

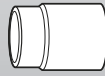

Dust Extraction Adaptor



Hex Key

# 3 YEAR REPLACEMENT WARRANTY

**JSW-6800**

## WARRANTY

IN ORDER TO MAKE A CLAIM UNDER THIS WARRANTY YOU MUST RETURN THE PRODUCT TO YOUR NEAREST BUNNINGS WAREHOUSE WITH YOUR BUNNINGS REGISTER RECEIPT. PRIOR TO RETURNING YOUR PRODUCT FOR WARRANTY PLEASE TELEPHONE OUR CUSTOMER SERVICE HELPLINE:

**Australia 1800 069 486**

**New Zealand 0508 069 486**

TO ENSURE A SPEEDY RESPONSE PLEASE HAVE THE MODEL NUMBER AND DATE OF PURCHASE AVAILABLE. A CUSTOMER SERVICE REPRESENTATIVE WILL TAKE YOUR CALL AND ANSWER ANY QUESTIONS YOU MAY HAVE RELATING TO THE WARRANTY POLICY OR PROCEDURE.

The benefits provided under this warranty are in addition to other rights and remedies which are available to you at law.

Our goods come with guarantees that cannot be excluded at law. You are entitled to a replacement or refund for a major failure and for compensation for any other reasonably foreseeable loss or damage. You are also entitled to have the goods repaired or replaced if the goods fail to be of acceptable quality and the failure does not amount to a major failure.

Generally you will be responsible for all costs associated with a claim under this warranty, however, where you have suffered any additional direct loss as a result of a defective product you may be able to claim such expenses by contacting our customer service helpline above.

### 3 YEAR REPLACEMENT WARRANTY

Your product is guaranteed for a period of **36 months from the original date of purchase** and is intended for DIY (Do It Yourself) use only. If a product is defective it will be replaced in accordance with the terms of this warranty. If a product is defective it will be replaced in accordance with the terms of this warranty.

Warranty excludes consumable parts, for example: saw blades, dust extraction adaptor, carbon brushes.

### WARNING

**The following actions will result in the warranty being void.**

- If the tool has been operated on a supply voltage other than that specified on the tool.
- If the tool shows signs of damage or defects caused by or resulting from abuse, accidents or alterations.
- Failure to perform maintenance as set out within the instruction manual.
- If the tool is disassembled or tampered with in any way.

# KNOW YOUR PRODUCT

## PENDULUM JIGSAW

- |                            |                         |
|----------------------------|-------------------------|
| 1 Variable Speed Dial      | 6 Guide Locking Screws  |
| 2 Lock On Switch           | 7 Guide Roller          |
| 3 On/Off Switch            | 8 Adjustable Shoe       |
| 4 Pendulum Action Selector | 9 Soft Grip Handle      |
| 5 Blade Lock               | 10 Dust Extraction Port |

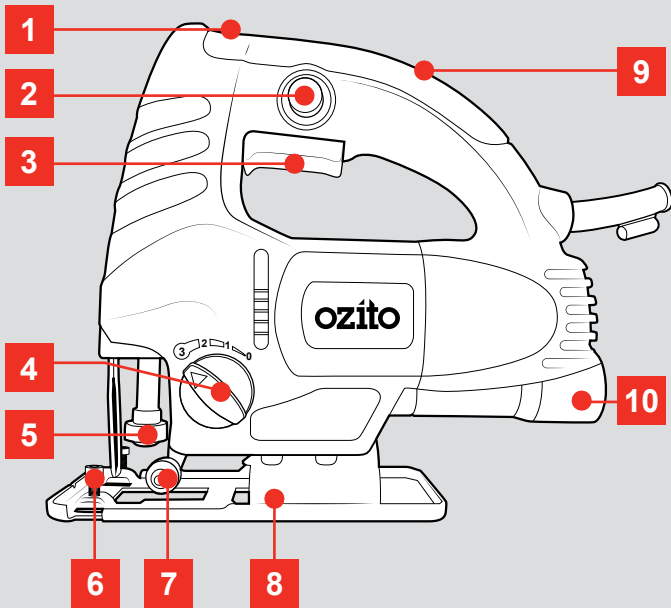

## ACCESSORIES

- |                            |                     |
|----------------------------|---------------------|
| 11 Parallel Guide          | 14 Timber Blade x 2 |
| 12 Hex Key                 | 15 Metal Blade x 1  |
| 13 Dust Extraction Adaptor |                     |

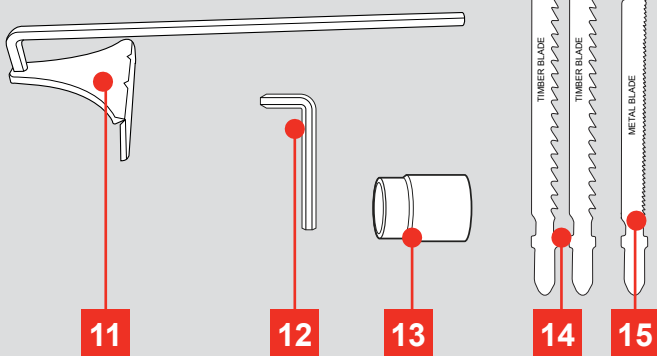

## ONLINE MANUAL

Scan this QR Code with your mobile device to take you to the online manual.



# SETUP & PREPARATION

## 1. CHANGING THE BLADE



**WARNING!** ENSURE THE SAW IS SWITCHED OFF AND DISCONNECTED FROM THE POWER SUPPLY BEFORE PERFORMING ANY OF THE FOLLOWING ASSEMBLY.

### Removing the Blade

- 1 Flip the saw upside down and rotate the blade lock.

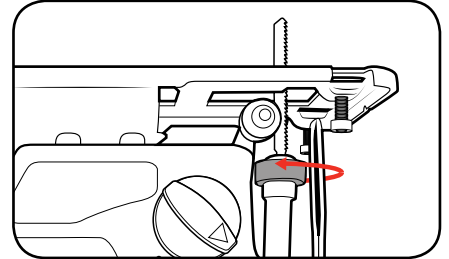

- 2 Raise the blade to remove.

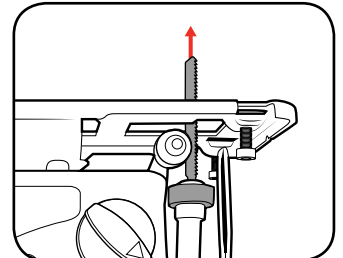

### Inserting the Blade

- 1 Flip the saw upside down and rotate the blade lock.

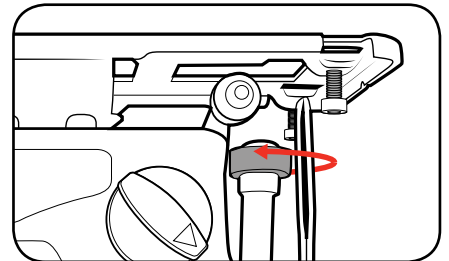

- 2 Slide the blade into the lock with the teeth facing forward making sure the blade is in the middle of the guide roller groove.

Ensure the shoulder of the blade sits right at the bottom of the blade holder.

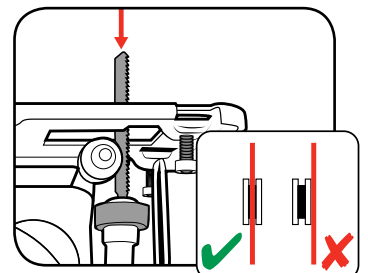

- 3 Release the blade lock and pull on the blade to ensure it is secured.

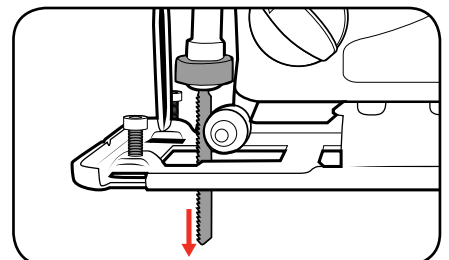

**3** YEAR REPLACEMENT WARRANTY

## 2. ADJUSTING SHOE ANGLE

The angle of the shoe can be adjusted to allow for bevel cuts between 0 and 45°.

- 1 Loosen the 2 screws at the bottom of the jigsaw using the hex key.

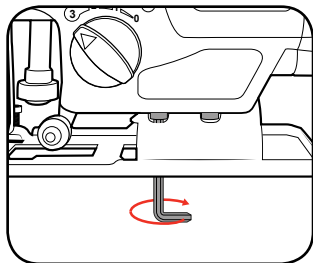

- 2 Slide the shoe backwards to allow the shoe to rotate.

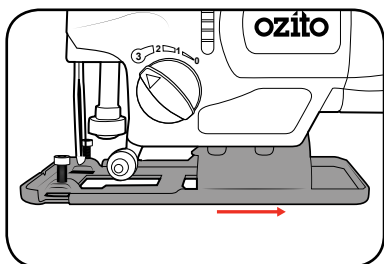

- 3 Tilt the shoe to the desired angle using the measurements.

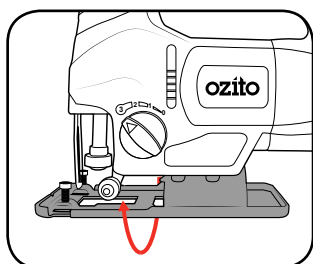

- 4 Once the angle is correct, slide the shoe forward for the pin to make contact.

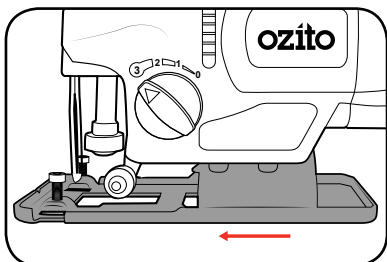

- 5 Secure in place tightening the 2 screws at the bottom of the jigsaw.

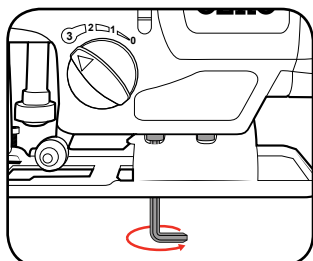

## 3. ATTACHING THE ACCESSORIES

### Attaching the Parallel Guide

The parallel guide assists in cutting in a line parallel to an edge.

- 1 Unscrew the 2 guide locking screws at the front of the jigsaw.

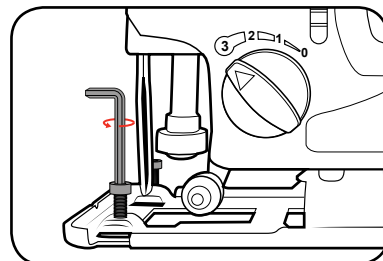

- 2 Slide the parallel guide into the slots under the locking screws.

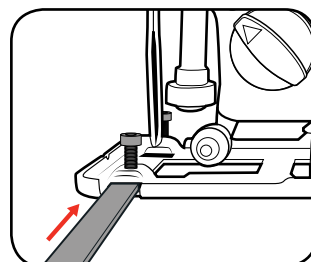

- 3 Tighten the guide locking screws to secure position.

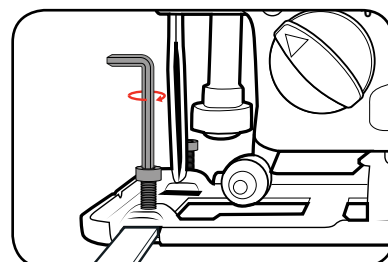

# OPERATION

## 4. DUST EXTRACTION

A dust extractor can be fitted to the jigsaw dust extractor adaptor to remove dust and chips while cutting. The adaptor can also be removed if it gets in the way.

### Dust Extraction Adaptor

- 1 Align the tabs on the adaptor with the recess in the extraction port, then rotate clockwise to secure in position.

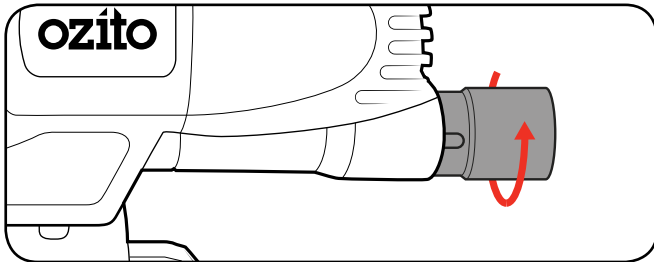

- 2 To remove, rotate anti-clockwise and pull away from the tool.

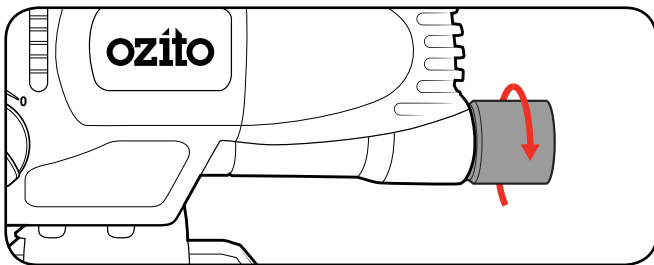

## 5. CONTROLS



**CAUTION!** TO REDUCE THE RISK OF ELECTRICAL SHOCK, THE USE OF A RESIDUAL CURRENT DEVICE (RATED 30mA OR LESS) IS RECOMMENDED.

### On/Off Trigger

- 1 To start cutting, squeeze the on/off trigger.

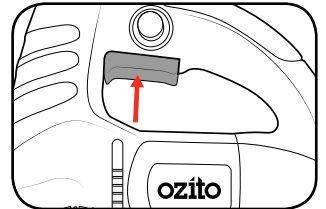

- 2 To stop cutting, release the on/off trigger.

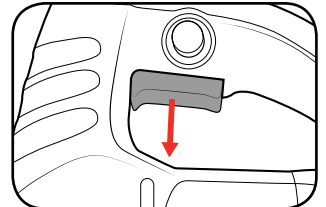

### Lock-On Button

The lock-on switch allows the jigsaw to continue operating without having to hold the on/off switch down.

- 1 Hold in the on/off trigger, then press the lock on button.

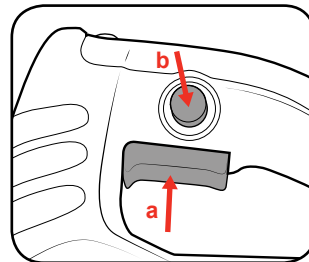

- 2 You can now release the on/off trigger & lock on button.

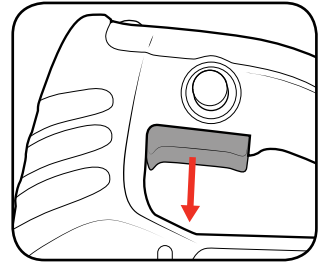

- 3 To stop the tool, squeeze and release the on/off trigger.

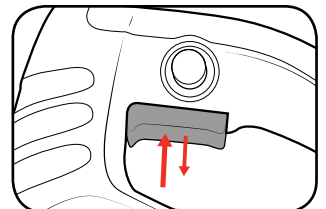

## 6. CONTROLS CONTINUED

### Adjusting the Cutting Speed

The cutting speed should be adjusted to match the material of the workpiece. In general, use fastener speeds for softer materials.

- 1 For faster speeds, rotate the variable speed dial to a higher number.  
For slower speeds, rotate the dial to a lower number.

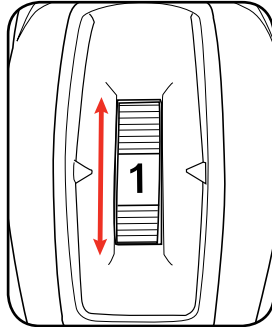

### Adjusting the Cutting Action

The jigsaw has a pendulum action feature which enables the blade to cut faster and more efficiently in thick and softer materials. See below for a guide on choosing the correct setting.

- 1 To use the pendulum action, rotate the pendulum action selector anti-clockwise to a higher setting.

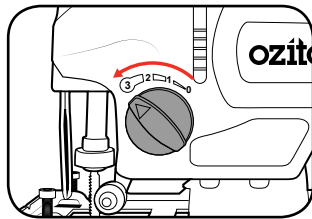

- 2 To use standard cutting action, rotate the pendulum action selector clockwise to a lower setting.

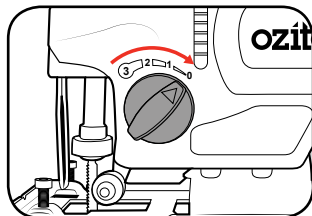

0 - exact	No pendulum action for fine clean cuts on thin or hard materials
1 - /	Small pendulum action for faster cutting on hard materials
2 - //	Medium pendulum action for faster cutting on softer materials
3 - ///	Large pendulum action for fast cutting along the grain on soft materials.

## 7. CUTTING

- 1 Ensure the correct blade is inserted into the blade lock and is secure.

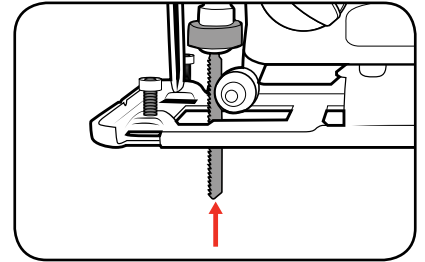

- 2 Mark your cutting line with a pencil or attach the parallel guide.

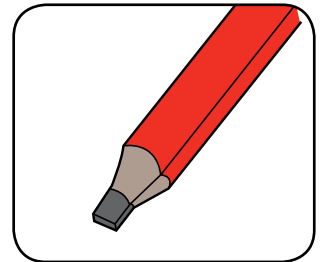

- 3 Place the base onto the workpiece with the blade away from the edge.

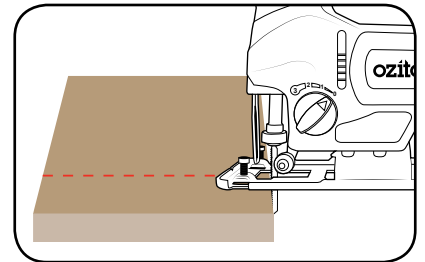

- 4 Hold the jigsaw firmly ensuring that your hands cannot slip down onto the blade and start the jigsaw by depressing the on/off switch.

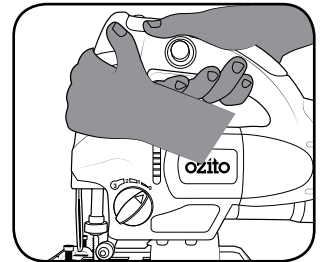

**CAUTION!** ENSURE HANDS AND FINGERS ARE KEPT WELL AWAY FROM THE BLADE AND THE CUTTING PATH AT ALL TIMES TO AVOID INJURIES.

- 5 Move jigsaw forward with light pressure. Allow the blade to stop before lifting the jigsaw away.

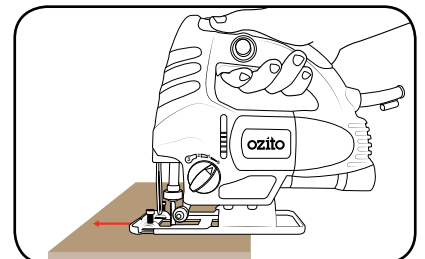

# OPERATION

# TROUBLESHOOTING

## 9. POCKET CUTTING

A pocket cut is when you need to cut a hole in the middle of a workpiece

- 1 Drill a hole in the workpiece using a drill bit.

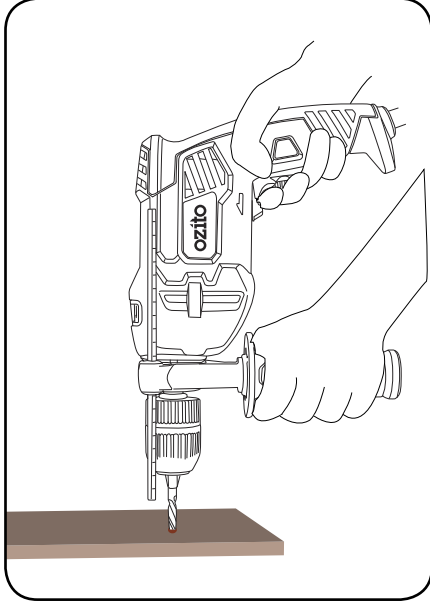

- 2 Pass the blade through the hole and begin the cut.

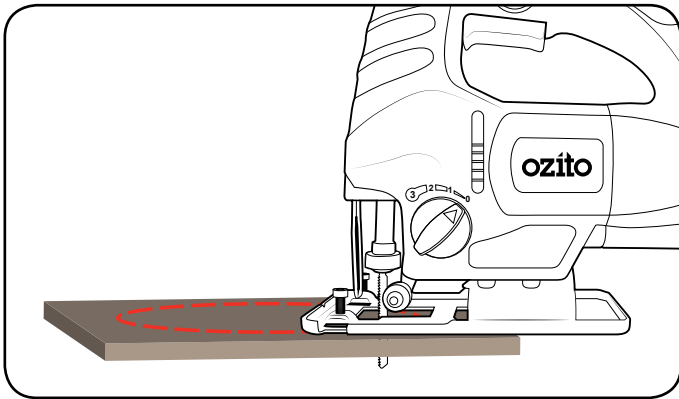

### Excessive sparking visible through the housing air vents and/or the jigsaw failing to operate



May indicate the carbon brushes have worn out and need to be replaced. Carbon brushes should only be replaced by a qualified electrician or power tool repairer.

### Cutting Metal

Your jigsaw can be used for cutting light gauge ferrous sheet and non-ferrous metals such as copper, brass, aluminium, etc. It is advisable when cutting sheet metal to clamp a backing sheet of soft wood or plywood to the work as this will enable you to obtain a clean cut without vibration and the possibility of tearing the metal. Both metal and wood backing are sawn together. Do not force the cutting blade into the metal as this will reduce the life of the blade and possibly damage the motor. Cutting thin metal will take longer than cutting even a relatively thick piece of wood, so do not be tempted to speed up the operation by forcing the saw. Spread a thin film of oil along the proposed cutting line before commencing to saw metal. Always select the right blade for the job.

# MAINTENANCE

1. After each use, blow air through the tool housing to ensure it is free from all dust particles that may build up. Build up of dust particles may cause the tool to overheat and fail.
2. If the enclosure of the tool requires cleaning do not use solvents but a moist soft cloth only. Never let any liquid get inside the tool; never immerse any part of the tool into a liquid.

## Carbon Brushes



When the carbon brushes wear out, the jigsaw will spark and/or stop. Discontinue use as soon as this happens. They should be replaced prior to recommencing use of the jigsaw. Carbon brushes are a wearing component of the jigsaw therefore not covered under warranty. Continuing to use the jigsaw when carbon brushes need to be replaced may cause permanent damage to the jigsaw. Carbon

brushes will wear out after many uses but when the carbon brushes need to be replaced, take the jigsaw to an electrician or a power tool repairer for a quick and low cost replacement. Always replace both carbon brushes at the same time.

*Note: Ozito Industries will not be responsible for any damage or injuries caused by the repair of the jigsaw by an unauthorised person or by mishandling of the jigsaw.*

# SPARE PARTS

Spare parts can be ordered from the Special Orders Desk at your local Bunnings Warehouse.

For further information, or any parts not listed here, visit [www.ozito.com.au](http://www.ozito.com.au) or contact Ozito Customer Service:

Australia 1800 069 486

New Zealand 0508 069 486

E-mail: [enquiries@ozito.com.au](mailto:enquiries@ozito.com.au)

# DESCRIPTION OF SYMBOLS

<b>V</b>	Volts	<b>Hz</b>	Hertz
<b>~</b>	Alternating current	<b>W</b>	Watts
<b>/min</b>	Revolutions per minute	<b>n<sub>o</sub></b>	No load speed
	Double insulated		Regulator compliance mark
	Warning		Read instruction manual

# CARING FOR THE ENVIRONMENT



Power tools that are no longer usable should not be disposed of with household waste but in an environmentally friendly way. Please recycle where facilities exist. Check with your local council authority for recycling advice.



Recycling packaging reduces the need for landfill and raw materials. Reuse of recycled material decreases pollution in the environment. Please recycle packaging where facilities exist. Check with your local council authority for recycling advice.

# ELECTRICAL SAFETY

 **WARNING!** When using mains-powered tools, basic safety precautions, including the following, should always be followed to reduce risk of fire, electric shock, personal injury and material damage.

Read the whole manual carefully and make sure you know how to switch the tool off in an emergency, before operating the tool.  
Save these instructions and other documents supplied with this tool for future reference.  
The manufacturer cannot accept any liability for damage or accidents which arise due to a failure to follow these instructions and the safety information.

This product has been designed for 230-240V only. Always check that the power supply corresponds to the voltage on the rating plate.

Note: The supply of 230-240V is interchangeable for Australia and New Zealand.



This tool is double insulated therefore no earth wire is required.

The power supply for this product should be protected by a residual current device (rated at 30mA or less). A residual current device reduces the risk of electric shock.

If the supply cord of this power tool is damaged, it must be replaced by a specially prepared cord available through the service organization.

**Note:** Double insulation does not take the place of normal safety precautions when operating this tool. The insulation system is for added protection against injury resulting from a possible electrical insulation failure within the tool.

## Using an Extension Lead

Always use an approved extension lead suitable for the power input of this tool. Before use, inspect the extension lead for signs of damage, wear and ageing. Replace the extension lead if damaged or defective.

When using an extension lead on a reel, always unwind the lead completely. Use of an extension lead not suitable for the power input of the tool or which is damaged or defective may result in a risk of fire and electric shock.

# GENERAL POWER TOOL SAFETY WARNINGS

 **WARNING!** Read all safety warnings and all instructions. Failure to follow the warnings and instructions may result in electric shock, fire and/or serious injury.  
Save all warnings and instructions for future reference. The term "power tool" in the warnings refers to your mains-operated (corded) power tool or battery-operated (cordless) power tool.

## 1. Work area safety

- Keep work area clean and well lit. Cluttered or dark areas invite accidents.
- Do not operate power tools in explosive atmospheres, such as in the presence of flammable liquids, gases or dust. Power tools create sparks which may ignite the dust or fumes.
- Keep children and bystanders away while operating a power tool. Distractions can cause you to lose control.

## 2. Electrical safety

- Power tool plugs must match the outlet. Never modify the plug in any way. Do not use any adapter plugs with earthed (grounded) power tools. Unmodified plugs and matching outlets will reduce risk of electric shock.
- Avoid body contact with earthed or grounded surfaces, such as pipes, radiators, ranges and refrigerators. There is an increased risk of electric shock if your body is earthed or grounded.
- Do not expose power tools to rain or wet conditions. Water entering a power tool will increase the risk of electric shock.
- Do not abuse the cord. Never use the cord for carrying, pulling or unplugging the power tool. Keep cord away from heat, oil, sharp edges or moving parts. Damaged or entangled cords increase the risk of electric shock.
- When operating a power tool outdoors, use an extension cord suitable for outdoor use. Use of a cord suitable for outdoor use reduces the risk of electric shock.
- If operating a power tool in a damp location is unavoidable, use a residual current device (RCD) protected supply. Use of an RCD reduces the risk of electric shock.

## 3. Personal safety

- Stay alert, watch what you are doing and use common sense when operating a power tool. Do not use a power tool while you are tired or under the influence of drugs, alcohol or medication. A moment of inattention while operating power tools may result in serious personal injury.
- Use personal protective equipment. Always wear eye protection. Protective equipment such as dust mask, non-skid safety shoes, hard hat, or hearing protection used for appropriate conditions will reduce personal injuries.
- Prevent unintentional starting. Ensure the switch is in the off-position before connecting to power source and/or battery pack, picking up or carrying the tool. Carrying power tools with your finger on the switch or energising power tools that have the switch on invites accidents.

- Remove any adjusting key or wrench before turning the power tool on. A wrench or a key left attached to a rotating part of the power tool may result in personal injury.
  - Do not overreach. Keep proper footing and balance at all times. This enables better control of the power tool in unexpected situations.
  - Dress properly. Do not wear loose clothing or jewellery. Keep your hair, clothing and gloves away from moving parts. Loose clothes, jewellery or long hair can be caught in moving parts.
  - If devices are provided for the connection of dust extraction and collection facilities, ensure these are connected and properly used. Use of dust collection can reduce dust-related hazards.
- ## 4. Power tool use and care
- Do not force the power tool. Use the correct power tool for your application. The correct power tool will do the job better and safer at the rate for which it was designed.
  - Do not use the power tool if the switch does not turn it on and off. Any power tool that cannot be controlled with the switch is dangerous and must be repaired.
  - Disconnect the plug from the power source and/or the battery pack from the power tool before making any adjustments, changing accessories, or storing power tools. Such preventive safety measures reduce the risk of starting the power tool accidentally.
  - Store idle power tools out of the reach of children and do not allow persons unfamiliar with the power tool or these instructions to operate the power tool. Power tools are dangerous in the hands of untrained users.
  - Maintain power tools. Check for misalignment or binding of moving parts, breakage of parts and any other condition that may affect the power tool's operation. If damaged, have the power tool repaired before use. Many accidents are caused by poorly maintained power tools.
  - Keep cutting tools sharp and clean. Properly maintained cutting tools with sharp cutting edges are less likely to bind and are easier to control.
  - Use the power tool, accessories and tool bits etc. in accordance with these instructions, taking into account the working conditions and the work to be performed. Use of the power tool for operations different from those intended could result in a hazardous situation.
- ## 5. Service
- Have your power tool serviced by a qualified repair person using only identical replacement parts. This will ensure that the safety of the power tool is maintained.

# JIGSAW SAFETY WARNINGS

 **WARNING!** The tool is recommended for use with a residual current device with a rated residual current of 30mA or less.

- Hold power tool by insulated gripping surfaces when performing an operation where the cutting accessory may contact hidden wiring or its own cord. Cutting accessory contacting a "live" wire may make exposed metal parts of the power tool "live" and could give the operator an electric shock.
- Remove all nails in the work piece before using the jigsaw. Cutting nails may damage your tool.
- Do not cut hollow pipe with the jigsaw
- Do not cut material thicker or of a wider diameter than the specified limits.
- Always allow enough clearance underneath the work piece to ensure the blade does not touch the floor or work bench, etc.
- Hold the tool at a comfortable distance from your body. Do not over reach to access the work piece.
- Do not touch moving parts with your fingers or hand.
- Do not cut through walls or cavities without first checking for hidden electrical wires.
- Ensure that you have tightened the blade prior to starting the machine.
- When you have finished the cut, wait until the saw blade has stopped moving prior to removing it from the work piece.
- Do not touch the saw blade immediately after use. Allow time for the blade to cool, as it may burn you due to the heat generated during sawing.
- Always check accessories to ensure that they are suitable for the operating speeds of this tool.
- Incorrect accessories can break apart at high speed and cause serious damage or injury.

This appliance is not intended for use by young or infirm persons unless supervised by a responsible person to ensure that they can use the appliance safely. Young children should be supervised to ensure that they do not play with the appliance.