

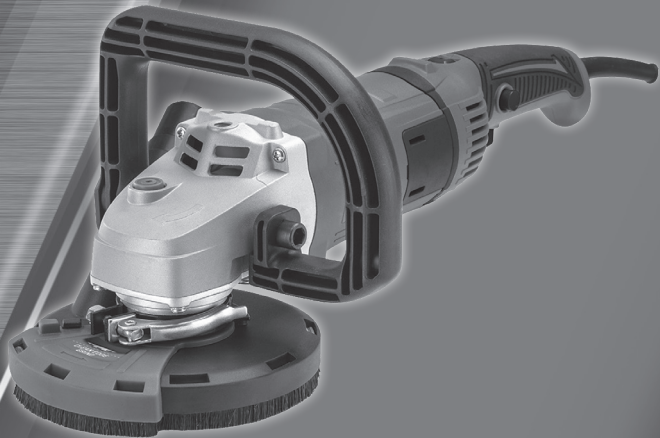

FULL BOAR

125MM CONCRETE GRINDER

- **1500W MOTOR**
- **VARIABLE SPEED CONTROL**
- **SOFT START MOTOR**



INSTRUCTION MANUAL



WARNING: Read all safety warnings and all instructions. Failure to follow the warnings and instructions may result in electric shock, fire and/or serious injury. Save all warnings and instructions for future reference.

SPECIFICATIONS - MODEL NO. FBCG-14125

Power:	1500W
Input:	230-240V ~50Hz
Diamond grinding disc:	Ø125 x Ø22.23 x 22mm
Spindle:	M14
No load speed:	3,000-8,500/min
Weight (tool only):	3.43kg

KNOW YOUR PRODUCT

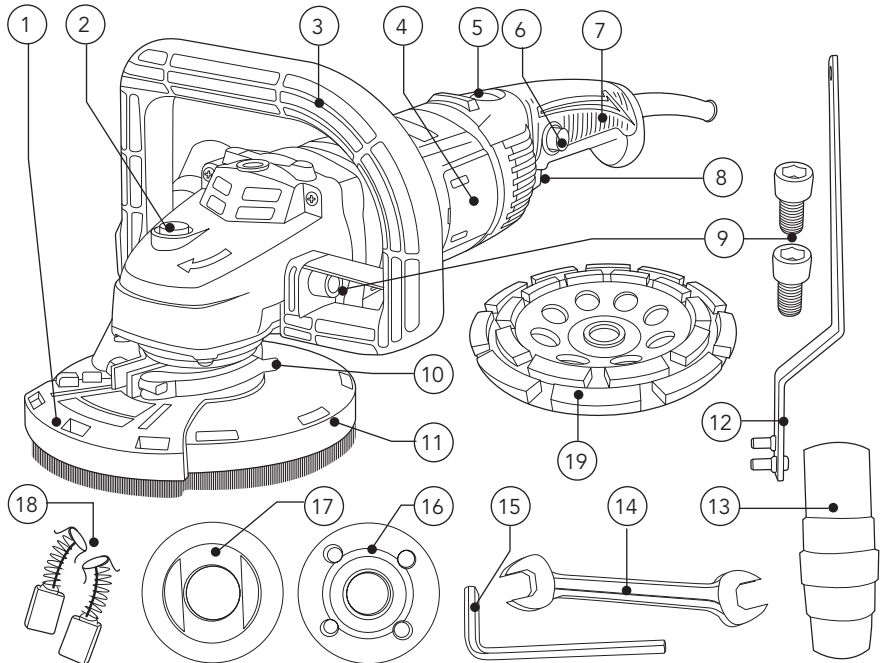

- | | | |
|---------------------------|-----------------------------------------------|------------------------------|
| 1. Pivoting guard | 8. On/off trigger switch
(with soft start) | 14. Spanner |
| 2. Spindle lock button | 9. Socket screw x 2 | 15. Hex key |
| 3. D-shaped handle | 10. Guard lever | 16. Flange nut |
| 4. Carbon brush cover x 2 | 11. Safety guard | 17. Inner flange |
| 5. Variable speed control | 12. Pin Spanner | 18. Carbon brush set (spare) |
| 6. Lock off button | 13. Dust port adaptor | 19. Diamond grinding disc |
| 7. Soft grip rear handle | | |

TABLE OF CONTENTS

SPECIFICATIONS.....	Page 02
KNOW YOUR PRODUCT.....	Page 02
INTRODUCTION.....	Page 04
SAFETY INSTRUCTIONS.....	Page 04
ASSEMBLY.....	Page 09
OPERATION.....	Page 11
MAINTENANCE.....	Page 14
DESCRIPTION OF SYMBOLS.....	Page 15
CONTENTS.....	Page 15
WARRANTY.....	Page 16

INTRODUCTION

Congratulations on purchasing a Full Boar Concrete Grinder. Your Full Boar Concrete Grinder FBCG-14125 gives the operator the flexibility to achieve a variety of applications, including epoxy removal and concrete grinding.

Read and understand the Owner's Manual before operating the Concrete Grinder. Failure to do so could result in personal injury or equipment damage.

SAFETY INSTRUCTIONS



WARNING! When using mains-powered equipment, basic safety precautions, including the following, should always be followed to reduce risk of fire, electric shock, personal injury and material damage.

Read and understand the manual prior to operating this tool.

Save these instructions and other documents supplied with this tool for future reference.

The manufacturer cannot accept any liability for damage or accidents which arise due to a failure to follow these instructions and the safety information.

ELECTRICAL SAFETY

This product has been designed for 230V and 240V only. Always check that the power supply corresponds to the voltage on the rating plate.

Note: The supply of 230V and 240V is interchangeable for Australia and New Zealand.



This tool is double insulated, therefore no earth wire is required.

The power supply for this product should be protected by a residual current device (rated at 30mA or less). A residual current device reduces the risk of electric shock.

If the supply cord of this power tool is damaged, it must be replaced by a specially prepared cord available through the service organization.

Note: Double insulation does not take the place of normal safety precautions when operating this tool. The insulation system is for added protection against injury resulting from a possible electrical insulation failure within the tool.

Using an Extension Lead

Always use an approved extension lead suitable for the power input of this tool. Before use, inspect the extension lead for signs of damage, wear and ageing. Replace the extension lead if damaged or defective. When using an extension lead on a reel, always unwind the lead completely. Use of an extension lead not suitable for the power input of the tool or which is damaged or defective may result in a risk of fire and electric shock.

GENERAL POWER TOOL SAFETY WARNINGS



WARNING! Read all safety warnings and all instructions. Failure to follow the warnings and instructions may result in electric shock, fire and/or serious injury. Save all warnings and instructions for future reference. The term "power tool" in the warnings refers to your mains-operated (corded) power tool or battery-operated (cordless) power tool.

SAVE THESE INSTRUCTIONS

1. Work area safety

- a. **Keep work area clean and well lit.** Cluttered or dark areas invite accidents.
- b. **Do not operate power tools in explosive atmospheres, such as in the presence of flammable liquids, gases or dust.** Power tools create sparks which may ignite the dust or fumes.
- c. **Keep children and bystanders away while operating a power tool.** Distractions can cause you to lose control.

2. Electrical safety

- a. **Power tool plugs must match the outlet. Never modify the plug in any way. Do not use any adapter plugs with earthed (grounded) power tools.** Unmodified plugs and matching outlets will reduce risk of electric shock.
- b. **Avoid body contact with earthed or grounded surfaces, such as pipes, radiators, ranges and refrigerators.** There is an increased risk of electric shock if your body is earthed or grounded.
- c. **Do not expose power tools to rain or wet conditions.** Water entering a power tool will increase the risk of electric shock.
- d. **Do not abuse the cord. Never use the cord for carrying, pulling or unplugging the power tool. Keep cord away from heat, oil, sharp edges or moving parts.** Damaged or entangled cords increase the risk of electric shock.
- e. **When operating a power tool outdoors, use an extension cord suitable for outdoor use.** Use of a cord suitable for outdoor use reduces the risk of electric shock.
- f. **If operating a power tool in a damp location is unavoidable, use a residual current device (RCD) protected supply.** Use of an RCD reduces the risk of electric shock.

3. Personal safety

- a. **Stay alert, watch what you are doing and use common sense when operating a power tool. Do not use a power tool while you are tired or under the influence of drugs, alcohol or medication.** A moment of inattention while operating power tools may result in serious personal injury.
- b. **Use personal protective equipment. Always wear eye protection.** Protective equipment such as dust mask, non-skid safety shoes, hard hat, or hearing protection used for appropriate conditions will reduce personal injuries.
- c. **Prevent unintentional starting. Ensure the switch is in the off-position before connecting to power source and/or battery pack, picking up or carrying the tool.** Carrying power tools with your finger on the switch or energising power tools that have the switch on invites accidents.
- d. **Remove any adjusting key or wrench before turning the power tool on.** A wrench or a key left attached to a rotating part of the power tool may result in personal injury.
- e. **Do not overreach. Keep proper footing and balance at all times.** This enables better control of the power tool in unexpected situations.
- f. **Dress properly. Do not wear loose clothing or jewellery. Keep your hair, clothing and gloves away from moving parts.** Loose clothes, jewellery or long hair can be caught in moving parts.
- g. **If devices are provided for the connection of dust extraction and collection facilities, ensure these are connected and properly used.** Use of dust collection can reduce dust-related hazards.
- h. **Do not let familiarity gained from frequent use of tools allow you to become complacent and ignore tool safety principles.** A careless action can cause severe injury within a fraction of a second.

GENERAL POWER TOOL SAFETY WARNINGS (cont.)

4. Power tool use and care

- a. **Do not force the power tool. Use the correct power tool for your application.** The correct power tool will do the job better and safer at the rate for which it was designed.
- b. **Do not use the power tool if the switch does not turn it on and off.** Any power tool that cannot be controlled with the switch is dangerous and must be repaired.
- c. **Disconnect the plug from the power source and/or the battery pack from the power tool before making any adjustments, changing accessories, or storing power tools.** Such preventive safety measures reduce the risk of starting the power tool accidentally.
- d. **Store idle power tools out of the reach of children and do not allow persons unfamiliar with the power tool or these instructions to operate the power tool.** Power tools are dangerous in the hands of untrained users.
- e. **Maintain power tools. Check for misalignment or binding of moving parts, breakage of parts and any other condition that may affect the power tool's operation. If damaged, have the power tool repaired before use.** Many accidents are caused by poorly maintained power tools.
- f. **Keep cutting tools sharp and clean.** Properly maintained cutting tools with sharp cutting edges are less likely to bind and are easier to control.
- g. **Use the power tool, accessories and tool bits etc. in accordance with these instructions, taking into account the working conditions and the work to be performed.** Use of the power tool for operations different from those intended could result in a hazardous situation.
- h. **Keep handles and grasping surfaces dry, clean and free from oil and grease.** Slippery handles and grasping surfaces do not allow for safe handling and control of the tool in unexpected situations.

5. Service

- a. **Have your power tool serviced by a qualified repair person using only identical replacement parts.** This will ensure that the safety of the power tool is maintained.
- b. **If the supply cord of this power tool is damaged, it must be replaced by a specially prepared cord available through the service organization.**

CONCRETE GRINDER SAFETY WARNINGS



WARNING! This appliance is not intended for use by persons (including children) with reduced physical, sensory or mental capabilities, or lack of experience and knowledge, unless they have been given supervision or instruction concerning use of the appliance by a person responsible for their safety.

Safety Warnings common for Grinding, Sanding, Wire brushing, Polishing or Abrasive Cut-Off Operations:

- a) **This power tool is intended to function as a grinder. Read all safety warnings, instructions, illustrations and specifications provided with this power tool.** Failure to follow all instructions listed below may result in electric shock, fire and/or serious injury.
- b) **Operations such as sanding, polisher, wire brushing or cutting-off are not recommended to be performed with this power tool.** Operations for which the power tool was not designed may create a hazard and cause personal injury.
- c) **Do not use accessories which are not specifically designed and recommended by the tool manufacturer.** Just because the accessory can be attached to your power tool, it does not assure safe operation.
- d) **The rated speed of the accessory must be at least equal to the maximum speed marked on the power tool.** Accessories running faster than their rated speed can break and fly apart.
- e) **The outside diameter and the thickness of your accessory must be within the capacity rating of your power tool.** Incorrectly sized accessories cannot be adequately guarded or controlled.
- f) **Threaded mounting of accessories must match the grinder spindle thread. For accessories mounted by flanges, the arbour hole of the accessory must fit the locating diameter of the flange.** Accessories that do not match the mounting hardware of the power tool will run out of balance, vibrate excessively and may cause loss of control.
- g) **Do not use a damaged accessory. Before each use inspect the accessory such as a backing pad for cracks, tears or excess wear. If power tool or accessory is dropped, inspect for damage or install an undamaged accessory. After inspecting and installing an accessory, position yourself and bystanders away from the plane of the rotating accessory and run the power tool at maximum no-load speed for one minute.** Damaged accessories will normally break apart during this test time.
- h) **Wear personal protective equipment. Depending on application, use face shield, safety goggles or safety glasses. As appropriate, wear dust mask, hearing protectors, gloves and workshop apron capable of stopping small abrasive or work piece fragments.** The eye protection must be capable of stopping flying debris generated by various operations. The dust mask or respirator must be capable of filtrating particles generated by your operation. Prolonged exposure to high intensity noise may cause hearing loss.
- i) **Keep bystanders a safe distance away from work area. Anyone entering the work area must wear personal protective equipment.** Fragments of work piece or of a broken accessory may fly away and cause injury beyond immediate area of operation.
- k) **Position the cord clear of the spinning accessory.** If you lose control, the cord may be cut or snagged and your hand or arm may be pulled into the spinning accessory.
- l) **Never lay the power tool down until the accessory has come to a complete stop.** The spinning accessory may grab the surface and pull the power tool out of your control.
- m) **Do not run the power tool while carrying it at your side.** Accidental contact with the spinning accessory could snag your clothing, pulling the accessory into your body.
- n) **Regularly clean the power tool's air vents.** The motor's fan will draw the dust inside the housing and excessive accumulation of powdered metal may cause electrical hazards.
- o) **Do not operate the power tool near flammable materials.** Sparks could ignite these materials.
- p) **Do not use accessories that require liquid coolants.** Using water or other liquid coolants may result in electrocution or shock.
- q) **Always use side handle.** Tighten the handle securely. The side handle should always be used to maintain control of the tool at all times.
- r) **When starting the tool with a new or replacement wheel, or a new or replacement wire brush installed, hold the tool in a well protected area and let it run for one minute.** If the wheel has an undetected crack or flaw, it should burst in less than one minute. If the wire brush has loose wires, they will be detected. Never start the tool with a person in line with the wheel. This includes the operator.
- s) **Use of accessories not specified in this manual is not recommended and may be hazardous.** Use of power boosters that would cause the tool to be driven at speeds greater than its rated speed constitutes misuse.

CONCRETE GRINDER SAFETY WARNINGS (cont.)

- t) **Use clamps or another practical way to secure and support the workpiece to a stable platform.** Holding the work by hand or against your body leaves it unstable and may lead to loss of control.
- u) **Avoid bouncing the wheel or giving it rough treatment.** If this occurs, stop the tool and inspect the wheel for cracks or flaws.
- v) Always handle and store wheels in a careful manner.
- w) **Do not operate this tool for long periods of time.** Vibration caused by the operating action of this tool may cause permanent injury to fingers, hands, and arms. Use gloves to provide extra cushion, take frequent rest periods, and limit daily time of use.
- x) **Air vents often cover moving parts and should be avoided.** Loose clothes, jewelry or long hair can be caught in moving parts.

Kickback and Related Warnings

Kickback is a sudden reaction to a pinched or snagged rotating wheel, backing pad, brush or any other accessory. Pinching or snagging causes rapid stalling of the rotating accessory which in turn causes the uncontrolled power tool to be forced in the direction opposite of the accessory's rotation at the point of the binding.

For example, if an abrasive wheel is snagged or pinched by the work piece, the edge of the wheel that is entering into the pinch point can dig into the surface of the material causing the wheel to climb out or kick out. The wheel may either jump toward or away from the operator, depending on direction of the wheel's movement at the point of pinching. Abrasive wheels may also break under these conditions. Kickback is the result of power tool misuse and/or incorrect operating procedures or conditions and can be avoided by taking proper precautions as given below.

- a) **Maintain a firm grip on the power tool and position your body and arm to allow you to resist kickback forces. Always use auxiliary handle, if provided, for maximum control over kickback or torque reaction during start-up.** The operator can control torque reactions or kickback forces, if proper precautions are taken.
- b) **Never place your hand near the rotating accessory.** Accessory may kickback over your hand.
- c) **Do not position your body in the area where power tool will move if kickback occurs.** Kickback will propel the tool in direction opposite to the wheel's movement at the point of snagging.
- d) **Use special care when working corners, sharp edges etc. Avoid bouncing and snagging the accessory.** Corners, sharp edges or bouncing have a tendency to snag the rotating accessory and cause loss of control or kickback.
- e) **Do not attach a saw chain woodcarving blade or toothed saw blade.** Such blades create frequent kickback and loss of control.

Additional safety instructions for grinding and cutting-off operations

Safety Warnings Specific for Grinding and Abrasive Cutting-Off Operations:

- a) **Use only wheel types that are recommended for your power tool and the specific guard designed for the selected wheel.** Wheels for which the power tool was not designed cannot be adequately guarded and are unsafe.
- b) **The grinding surface of centre depressed wheels must be mounted below the plane of the guard lip.** An improperly mounted wheel that projects through the plane of the guard lip cannot be adequately protected.
- c) **The guard must be securely attached to the power tool and positioned for maximum safety, so the least amount of wheel is exposed towards the operator.** The guard helps to protect operator from broken wheel fragments and accidental contact with wheel.

NOTE: The above warning may be omitted for die grinders and grinders or cut-off grinders with rated capacity of less than 55 mm.

- d) **Wheels must be used only for recommended applications. For example: do not grind with the side of cut-off wheel.** Abrasive cut-off wheels are intended for peripheral grinding, side forces applied to these wheels may cause them to shatter.
- e) **Always use undamaged wheel flanges that are of correct size and shape for your selected wheel.** Proper wheel flanges support the wheel thus reducing the possibility of wheel breakage. Flanges for cut-off wheels may be different from grinding wheel flanges.
- f) **Do not use worn down wheels from larger power tools.** Wheel intended for larger power tool is not suitable for the higher speed of a smaller tool and may burst.

ASSEMBLY



WARNING! During assembly ensure the concrete grinder is switched OFF and disconnected from the power supply.

D-shaped handle (3) (fig. 1-3).

1. Align the recess on the D-shaped handle to the ridge on the metal gear case.

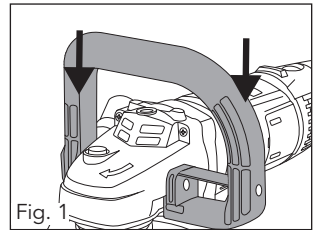

2. Slide the D-shaped handle on and insert the socket screws (9) either side.

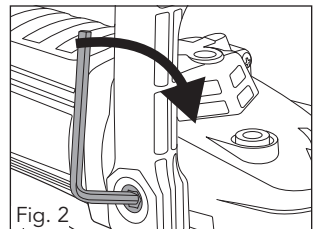

3. Now tighten the socket screws using a hex key (15) to secure the D-shaped handle in place.

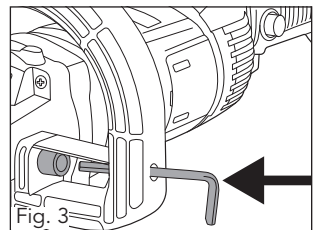

ASSEMBLY (cont).

Safety guard (11) (fig. 4-6)

The safety guard must be used at all times whilst operating the concrete grinder.

1. Release the guard lever (10) and place safety guard on spindle neck.

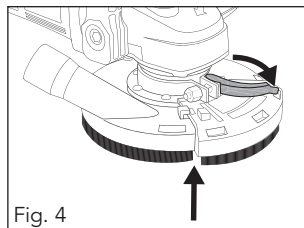

2. If the safety guard will not fit over the spindle neck, loosen the guard nut with the spanner (14) and rotate the safety guard slightly left and right to aid fitment.

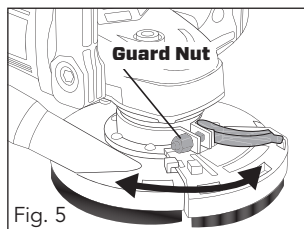

3. Close the guard lever to lock the safety guard in position.

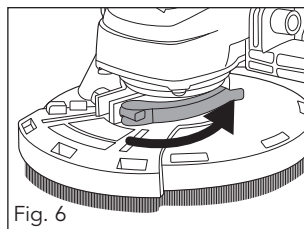

WARNING! When the guard nut is over tightened the guard lever (10) will not be able to close properly. If the guard nut is too loose the guard lever will close but will not securely fasten the guard to the spindle neck.

OPERATION

Spindle lock button (2) (fig. 7)

The spindle lock button is provided to prevent the spindle from rotating when installing or removing a disc (19). Operate the spindle lock button only when the tool is turned off, the tool is unplugged, and the disc has come to a complete stop.

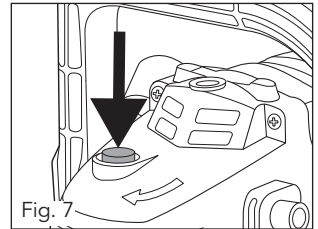

Fitting / Removing diamond grinding disc (fig. 8)

Inspect the diamond grinding disc (19) before fitment to ensure it is not cracked or deformed. The diamond grinding disc is suitable for grinding tasks only. Only use grinding discs with a diameter of 125mm, bore 22.23mm, height 22mm.

1. Fit the inner flange (17) on the spindle. The flange should not turn on the spindle when properly attached.
2. Lay the diamond grinding disc (19) on the inner flange (17) so that it lies flat along the flange.
3. The two sides of the flange nut (16) are different. Screw the flange nut (16) onto the spindle so that the flat surface of the flange nut (16) is in contact with the diamond grinding disc (19).

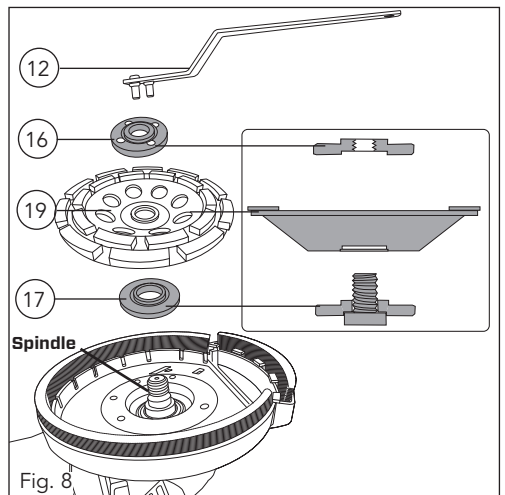

4. Depress the spindle lock button (2) and turn the flange nut (16) by hand until you feel the spindle lock engage.



WARNING! Press in the spindle lock button (2) only when the spindle is stationary.

5. Use pin spanner (12), turning clockwise to firmly tighten the flange nut (16).
6. To remove disc, depress the spindle lock button (2) to hold the diamond grinding disc (19) steady, then turn the flange nut (16) anti-clockwise with the pin spanner (12)

OPERATION (cont.)



WARNING! To reduce the risk of electric shock, a residual current device rated at 30mA or less should be used..

Variable speed control (5) (fig. 9)

Set the optimum speed on the variable speed control (5) depending on the application

1. To increase the speed of the concrete grinder, use your thumb to rotate the variable speed control upwards to a higher speed (8,500 rpm max.).
2. To decrease the speed of the concrete grinder, rotate the variable speed control downwards to a slower speed (3,000 rpm min.).

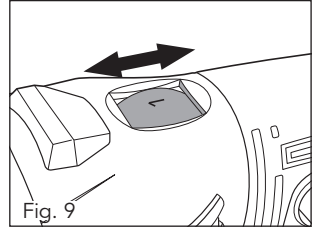

On/Off trigger (8)

Always use the D-shaped front handle (3) and firmly hold the tool by soft grip rear handle (7) during operations.

The concrete grinder is fitted with a lock-off button (6) to avoid accidental start up.

1. First press and hold the lock-off button (6) (fig. 10).
2. Squeeze the On/off trigger (8) to start the concrete grinder. Hold the trigger in this position for continuous use (fig. 11).

Note: Once the tool has started, you can release the lock-off button (6).

Note: For added safety, the concrete grinder is fitted with an on/off trigger with soft start, this is an added safety feature which reduces the start up torque which can cause the tool to twist quickly. On starting the concrete grinder, let it reach its full speed prior to attempt grinding.

3. To stop the grinding, release the on/off trigger (fig. 12).

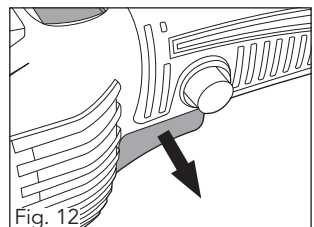
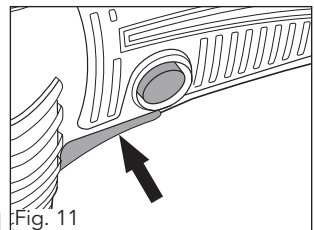
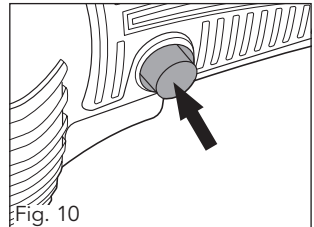

OPERATION (cont.)

Dust extraction



WARNING! For health and safety reasons, this concrete grinder should be used with a suitable dust extraction unit at all times.

The Full Boar Concrete Grinder comes complete with a dust extraction adaptor (13) that can be fitted to the dust port (fig. 13) and used with a dust extraction unit or vacuum to minimise the amount of dust in the air and on the working surface. Please note that the vacuum or dust extraction unit should have a self cleaning filtration system to prevent clogging the filter and potentially overheating the unit.

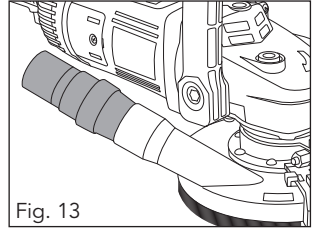

Working close to walls



WARNING! Always ensure before opening or closing the pivoting guard (1) the concrete grinder is switched OFF and disconnected from the power supply and the diamond grinding disc (19) is stopped completely.

Only open pivoting guard (1) when working close to walls, otherwise the pivoting guard must be closed (fig. 14).

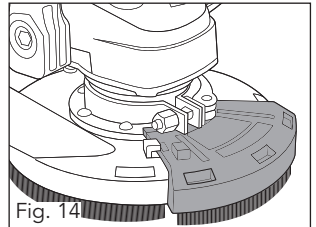

The open area of the safety guard (11) (fig. 15) must face the direction of the wall.

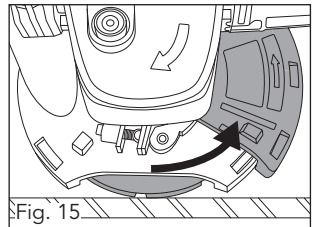

MAINTENANCE



WARNING! Ensure the concrete grinder is switched off and disconnected from the power supply before performing any maintenance or cleaning.

- Keep the ventilation vents of the concrete grinder clean at all times.
- After each use, blow low pressure air through the concrete grinder housing to ensure it is free from all dust particles which may build up. Build up of dust particles may cause the grinder to overheat and fail.
- If the enclosure of the concrete grinder requires cleaning, do not use solvents but a moist soft cloth only. Never let any liquid get inside the tool; never immerse any part of the grinder into a liquid.



Carbon Brushes

When the carbon brushes wear out, the concrete grinder will spark and/or stop. Discontinue use as soon as this happens. They should be replaced prior to recommencing use of the grinder. Carbon brushes are a wearing component of the concrete grinder therefore not covered under warranty. Continuing to use the tool

when carbon brushes need to be replaced may cause permanent damage to the grinder. Carbon brushes will wear out after many uses but when the carbon brushes need to be replaced, take the concrete grinder to an electrician or a power tool repairer for a quick and low cost replacement. Always replace both carbon brushes at the same time.

Note: Ozito Industries will not be responsible for any damage or injuries caused by the repair of the concrete grinder by an unauthorised person or by mishandling of the grinder

Spare Parts

Limited spare parts are available subject to availability. Please contact your local Bunnings Special Orders Desk to order the required spare parts.

CARING FOR THE ENVIRONMENT









Power tools that are no longer usable should not be disposed of with household waste but in an environmentally friendly way. Please recycle where facilities exist. Check with your local council authority for recycling advice.



Recycling packaging reduces the need for landfill and raw materials. Reuse of recycled material decreases pollution in the environment. Please recycle packaging where facilities exist. Check with your local council authority for recycling advice.

DESCRIPTION OF SYMBOLS

V	Volts	Hz	Hertz
~	Alternating current	W	Watts
/min	Revolutions or reciprocation per minute	n_0	No load speed
mm	Millimetres	∅	Diameter
	Double insulated		Regulator compliance mark
	Warning		Wear ear, eye and breathing protection
	Decibel level		Read instruction manual

CONTENTS

- 1 x Concrete grinder
- 1 x Safety guard
- 1 x Diamond grinding disc $\text{Ø}125 \times \text{Ø}22.23 \times 22\text{mm}$
- 1 x D-shaped front handle
- 1 x Dust port adaptor
- 2 x Socket screws
- 1 x Pin spanner
- 1 x Hex key
- 1 x Spanner
- 2 x Carbon brushes (spare)

Note. The manufacturer's liability shall be deemed void if the machine is modified in any way and the manufacturer shall therefore accept no liability for any damages arising as a result of modifications.

Distributed by:

Ozito Industries Pty Ltd

AUSTRALIA (Head Office)

1-23 Letcon Drive, Bangholme Victoria, Australia, 3175

Telephone: 1800 069 486 AUS

WARRANTY

YOUR WARRANTY FORM SHOULD BE RETAINED BY YOU AT ALL TIMES. IN ORDER TO MAKE A CLAIM UNDER THIS WARRANTY YOU MUST RETURN THE PRODUCT TO YOUR NEAREST BUNNINGS WAREHOUSE (see www.bunnings.com.au or www.bunnings.co.nz for store locations) WITH YOUR BUNNINGS REGISTER RECEIPT. PRIOR TO RETURNING YOUR PRODUCT FOR WARRANTY PLEASE TELEPHONE OUR CUSTOMER SERVICE HELPLINE:

**Australia 1800 069 486
New Zealand 0508 069 486**

TO ENSURE A SPEEDY RESPONSE PLEASE HAVE THE MODEL NUMBER AND DATE OF PURCHASE AVAILABLE. A CUSTOMER SERVICE REPRESENTATIVE WILL TAKE YOUR CALL AND ANSWER ANY QUESTIONS YOU MAY HAVE RELATING TO THE WARRANTY POLICY OR PROCEDURE.

1 YEAR WARRANTY

Your product is guaranteed for a period of **12 months from the original date of purchase**. If a product is defective it will be repaired in accordance with the terms of this warranty. Warranty excludes consumable parts, for example: wheels, bearings.

The benefits provided under this warranty are in addition to other rights and remedies which are available to you under law. The warranty covers manufacturer defects in materials, workmanship and finish under normal use.

Our goods come with guarantees that cannot be excluded under Australian Consumer law & Consumer Guarantees Act 1993 (NZ). You are entitled to a replacement or refund for a major failure and to compensation for other reasonably foreseeable loss or damage. You are also entitled to have the goods repaired and replaced if the goods fail to be of acceptable quality and the failure does not amount to a major failure.

WARRANTY EXCLUSIONS

The following actions will result in the warranty being void.

- If the tool has been operated on a supply voltage other than that specified on the tool.
- If the tool shows signs of damage or defects caused by or resulting from abuse, accidents or alterations.
- Failure to perform maintenance as set out within the instruction manual.
- If the tool is disassembled or tampered with in any way.
- The warranty excludes damage resulting from product misuse or product neglect.

This warranty is given by Ozito Industries Pty Ltd.

ABN: 17 050 731 756

Ph.1800 069 486

Australia/New Zealand (Head Office)
1-23 Letcon Drive, Bangholme, Victoria, Australia 3175