



R36XBLWC0
R36XBLWC4



IMPORTANT!

It is essential that you read the instructions in this manual before assembling, operating, and maintaining the product.

Subject to technical modification.

Safety, performance, and dependability have been given top priority in the design of your cordless blower.

INTENDED USE

The cordless blower is intended only for outdoor use, in dry and well-illuminated conditions.

The product is not intended to be used by children or persons with reduced physical, mental, or sensory capabilities.

The product is designed for blowing light debris, such as leaves, grass, and other garden refuse.

Do not use the product for any other purpose.

GENERAL SAFETY WARNINGS

⚠ WARNING! Read all safety warnings and all instructions. Failure to follow the warnings and instructions may result in electric shock, fire, and/or serious injury. Save all warnings and instructions for future reference.

⚠ WARNING! Never allow children or people who are unfamiliar with these instructions to use the product. Local regulations may restrict the age of the operator.

TRAINING

- Read the instructions carefully. Be familiar with the controls and the correct use of the product.
- Keep in mind that the operator or user is responsible for accidents or hazards occurring to other people or their property.
- Do not use the product while tired, ill, or under the influence of drugs, alcohol, or medication.

PREPARATION

- Some regions have regulations that restrict the use of the product to some operations. Check with your local authority for advice.
- Wear hearing protection at all times while operating the product. The product is noisy, and not strictly adhering to precautions to limit your exposure and to reduce noise

may result to permanent hearing injury.

- Wear full eye protection at all times while operating the product. Wear a full face mask or fully enclosed goggles. Normal spectacles or sunglasses are not adequate protection. Objects can be thrown at high speed by the powerful air jet at any time and may rebound from hard surfaces toward the operator.
- While operating the product, always wear substantial footwear and long trousers. Do not operate the product when barefoot or wearing open sandals. Avoid wearing clothing with loose fitting or that has hanging cords or ties.
- Do not wear loose clothing or jewellery that can be drawn into the air inlet. Secure long hair so it is above shoulder level to prevent entanglement in moving parts.
- Before each use, ensure that all controls and safety devices function correctly. Do not use the product if the off switch does not stop the product.
- Operate the product in the recommended position and only on a firm and level surface.
- Do not operate the product on a paved or gravel surface where ejected material could cause injury.
- Before each use, always inspect the housing for damage. Ensure that guards and handles are in place and properly secured. Replace worn or damaged components in sets to preserve balance. Replace damaged or unreadable labels.
- Never operate the product while people, especially children, or pets are nearby.
- Keep all cooling air inlets clear of debris.
- Use rakes and brooms to loosen debris before blowing.
- Clear the work area before each use. Remove all objects such as rocks, broken glass, nails, wire, or string that can be blown a considerable distance by high velocity air.
- Injuries may be caused or aggravated by prolonged use of a tool. When using any tool for prolonged periods, ensure you take regular breaks.

BATTERY TOOL USE AND CARE

- Recharge only with the charger specified by the manufacturer. A charger that is suitable for one type of battery pack may create a risk of fire when used with another battery pack.
- Use power tools only with specifically designated battery packs. Use of any other battery packs may create a risk of injury and fire.
- When battery pack is not in use, keep it away from other metal objects, like paper clips, coins, keys, nails, screws, or other small metal objects that can make a connection from one terminal to another. Shorting the battery pack terminals together may cause burns or a fire.
- Under abusive conditions, liquid may be ejected from the battery pack; avoid contact. If contact accidentally occurs, flush with water. If liquid contacts eyes, additionally seek medical help. Liquid ejected from the battery pack may cause irritation or burns.
- Do not use a battery pack or tool that is damaged or modified. Damaged or modified batteries may exhibit unpredictable behaviour resulting in fire, explosion, or risk of injury.
- Do not expose a battery pack or tool to fire or excessive temperatures. Exposure to fire or excessive temperature above 130°C may cause explosion.
- Follow all charging instructions and do not charge the battery pack or tool outside the temperature range specified in the instructions. Charging improperly or at temperatures outside the specified range may damage the battery and increase the risk of fire.

OPERATION

- Operate the product only at reasonable hours—not early in the morning or late at night when people might be disturbed.
- Never operate the product in an explosive atmosphere.
- Avoid using the product in bad weather conditions, especially when there is a risk of lightning.
- Keep bystanders, children, and pets 15 m away from the area of operation. Stop the product if anyone enters the area.

- Do not operate the product in poor lighting. The operator requires a clear view of the work area to identify potential hazards.
- Operating similar tools nearby increases both the risk of hearing injury and the potential for other persons to enter your working area.
- Always be sure of your footing on slopes. Walk, never run.
- Keep proper footing and balance. Do not overreach. Overreaching can result in loss of balance.
- Never use the product with defective guards or shields, or without safety devices in place.
- To reduce the risk of injury associated with contacting rotating parts, always turn off the product and remove the battery pack. Make sure that all moving parts have come to a complete stop:
 - before leaving the product unattended
 - before clearing blockages
 - before checking, cleaning, or working on the product
 - before inspecting the product after striking a foreign object
 - whenever the product starts to vibrate abnormally (inspect immediately)
- Immediately turn off the product and remove the battery pack in the event of accident or breakdown. Do not operate the product again until it has been fully checked by an authorised service centre.
- Do not modify the product in any way or use parts and accessories that are not recommended by the manufacturer.
- If the product is dropped, suffers heavy impact, or begins to vibrate abnormally, immediately stop the product and inspect for damage or identify the cause of the vibration. Any damage should be properly repaired or replaced by an authorised centre.

BLOWER SAFETY WARNINGS

- Wear a face filter mask in dusty conditions to reduce the risk of injury associated with the inhalation of dust.
- Slightly dampen surfaces in dusty conditions.
- Do not use the product near open windows.
- Use the full blower nozzle extension so that

the air stream can work close to the ground and perform effectively.

- Do not point the blower nozzle in the direction of people or pets.
- Never place objects inside the blower tubes.
- Do not place the product on top of or near loose debris. Debris can be sucked into the intake vent, resulting in possible damage to the product.

ADDITIONAL BATTERY SAFETY WARNINGS

To reduce the risk of fire, personal injury, and product damage due to a short circuit, never immerse the product, battery pack, or charger in fluid or allow fluid to flow inside them. Corrosive or conductive fluids, such as seawater, certain industrial chemicals, and bleach or bleach-containing products, etc., can cause a short circuit.

TRANSPORTATION AND STORAGE

- Turn off the product, remove the battery pack, and allow it to cool down before storing or transporting.
- Remove all foreign materials from the product. Store the product in a cool, dry, and well-ventilated place that is inaccessible to children. Keep the product away from corrosive agents, such as garden chemicals and de-icing salts. Do not store the product outdoors.
- For transportation in a vehicle, secure the product against movement or falling to prevent injury to persons or damage to the product.

TRANSPORTING LITHIUM BATTERIES

Transport the battery pack in accordance with local and national provisions and regulations.

Follow all special requirements on packaging and labelling when transporting batteries by a third party. Ensure that no batteries can come in contact with other batteries or conductive materials while in transport by protecting exposed connectors with insulating, non-conductive caps or tape. Do not transport battery packs that are cracked or leaking. Check with the forwarding company for further advice.

MAINTENANCE

- Use only original manufacturer's replacement parts, accessories, and attachments. Failure to do so can cause possible injury, can contribute to poor performance, and may void your warranty.
- Servicing requires extreme care and knowledge and should be performed only by a qualified service technician. Have the product serviced by an authorised service centre only.
- Check all nuts, bolts, and screws at frequent intervals for proper tightness to ensure that the product is in safe working condition. Any part that is damaged should be properly repaired or replaced by an authorised service centre.
- Bring the product to an authorised service centre to replace damaged or unreadable labels.
- You may make adjustments or repairs that are described in this manual. For other repairs, contact an authorised service centre.
- After each use, clean the product with a soft, dry cloth.

CLEARING A BLOCKAGE

- To reduce the risk of injury associated with contacting moving parts, always turn off the product, remove the battery pack, and make sure that all moving parts have come to a complete stop.
- Remove the blower tubes to inspect for blockage. Clear the tubes if required.
- Reinstall the blower tubes before starting the product.

SYMBOLS ON THE PRODUCT



Read and understand all instructions before operating the product. Follow all warnings and safety instructions.



Beware of thrown or flying objects. Keep all bystanders, especially children, and pets, at least 15 m away from the operating area.

SYMBOLS IN THIS MANUAL



Rotating fans. Keep hands and feet out of openings while the product is running.



Wear ear protection.



Wear eye protection.



Do not expose the product to rain or damp conditions.



Guaranteed sound power level



Remove the battery before starting any maintenance work on the product.



Regulatory Compliance Mark (RCM). This product meets applicable regulatory requirements.



Speed up



Speed down, on/off



Waste electrical products should not be disposed of with household waste. Recycle where facilities exist. Check with your local authority or retailer for recycling advice.



Note



Warning



Parts or accessories are sold separately

R36XBLWC0

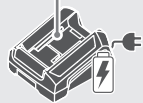
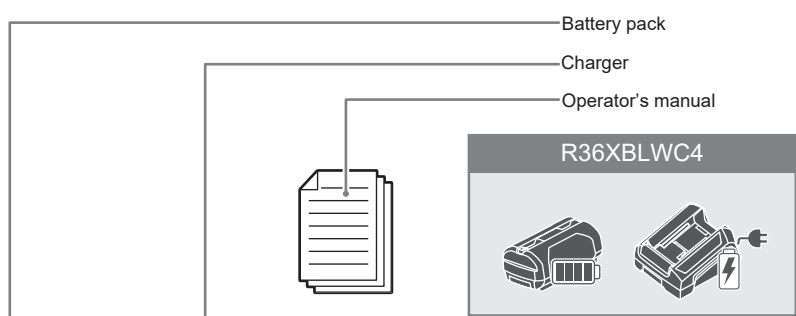
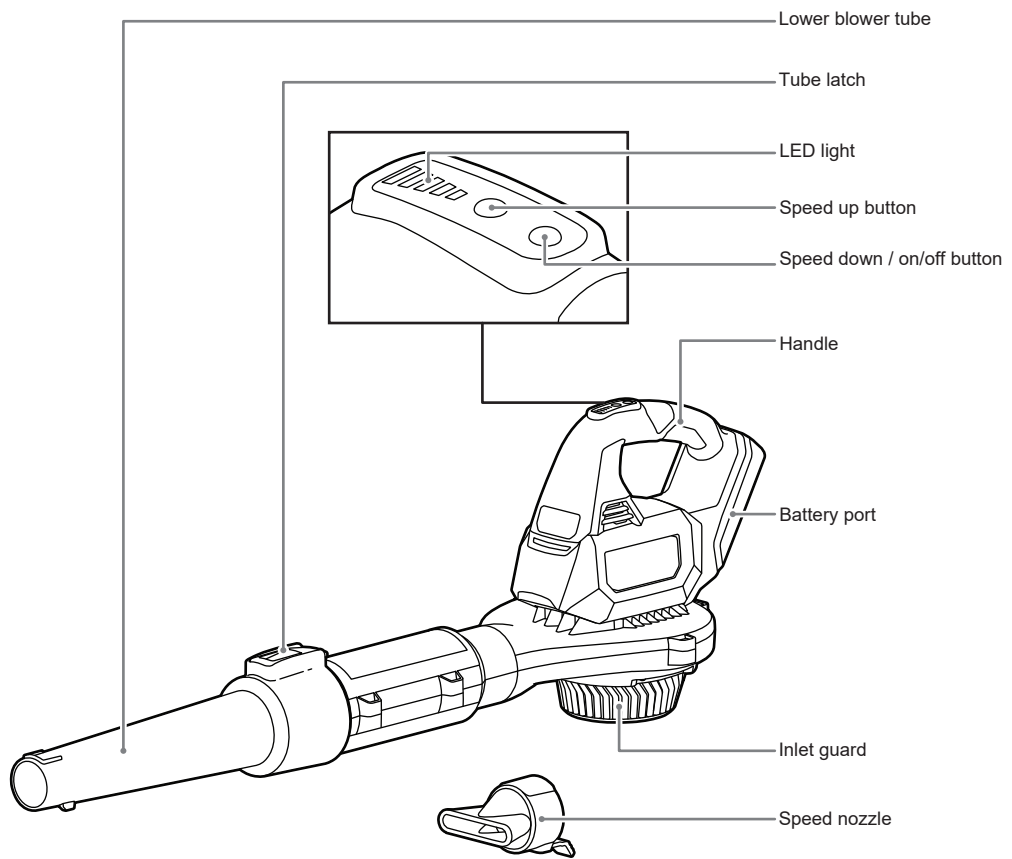

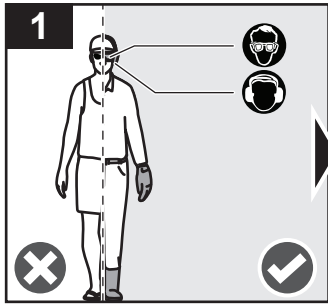

Wear full eye and ear protection, substantial footwear, and long trousers at all times while operating the product. Do not operate the product when barefoot or wearing open sandals.

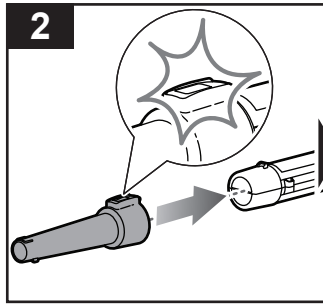

Insert the lower blower tube into the product until it clicks into place.

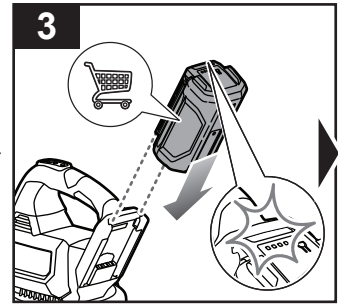

Insert the battery pack into the battery port until it clicks into place.

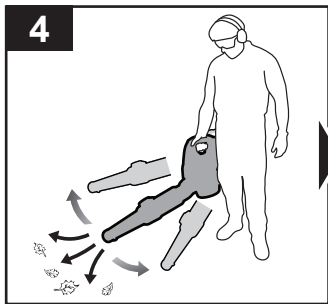

Operate the product in the recommended position as shown. Always hold the product by the designated handle and use the lowest speed necessary to achieve the task.

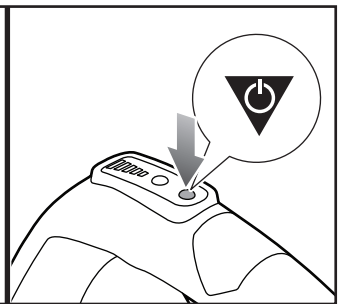
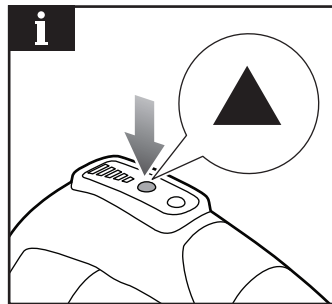

NOTE: Press the speed up button to increase the speed of the product. Press and hold the power button to decrease the speed of the product.

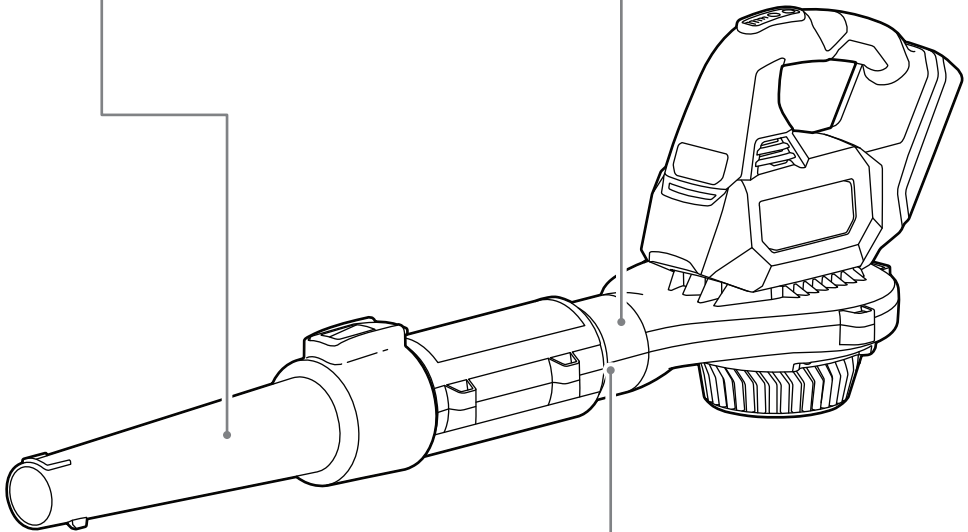
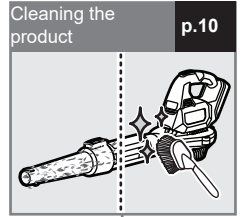
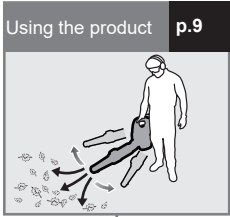

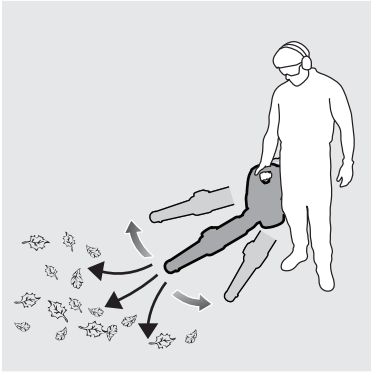

USING THE PRODUCT

WARNING: The product must be connected to the lower blower tube at all times.

1. Insert the battery pack into the battery port until the latch clicks into place. Make sure that the battery pack is securely attached before using the product.
2. Press and hold the speed down / on/off button to turn on the product.

NOTE: Insert the speed nozzle into the lower blower tube until it clicks into place. Operate the product in the recommended position as shown. Always hold the product by the designated handle and use the lowest speed necessary to achieve the task.

NOTE: Press the speed up button to increase the speed of the product. Press the speed down button to decrease the speed of the product.

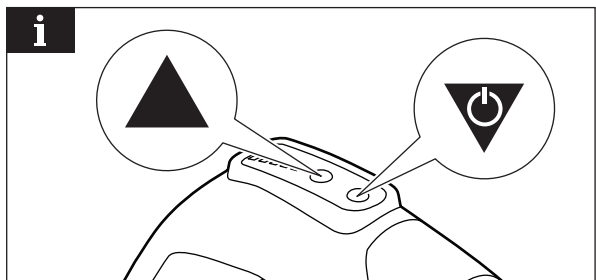
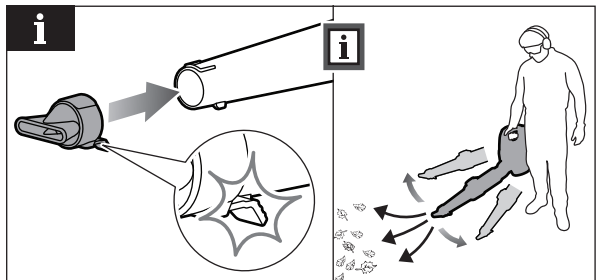
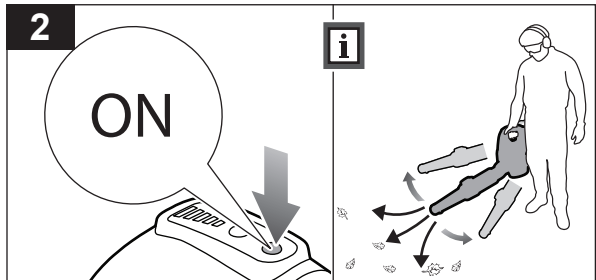
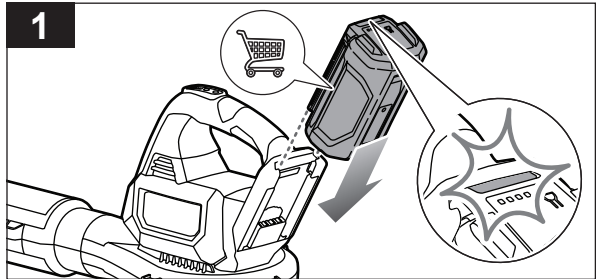
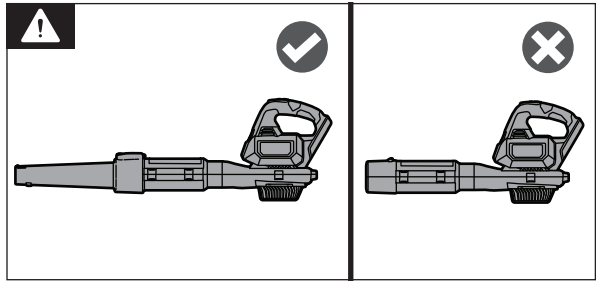

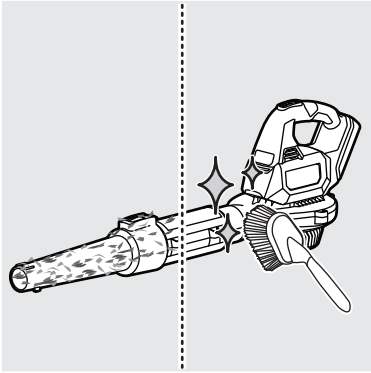

CLEANING THE PRODUCT

1. Press the latch and remove the battery pack.
2. Clean the product with a stiff brush. Remove all foreign materials.

WARNING: Do not use water to clean the product.

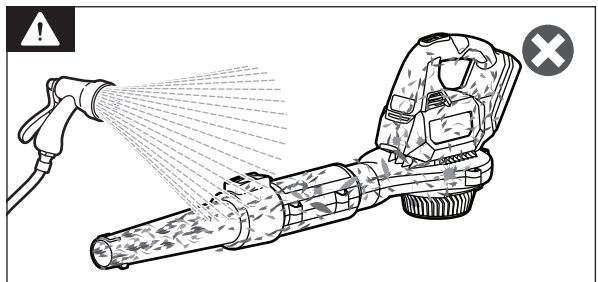
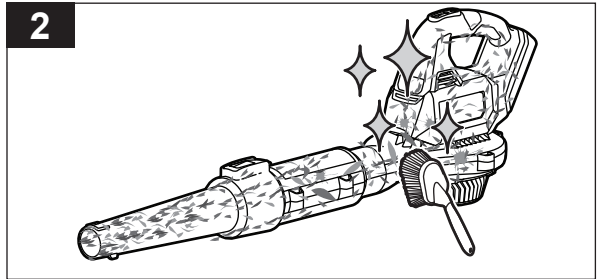
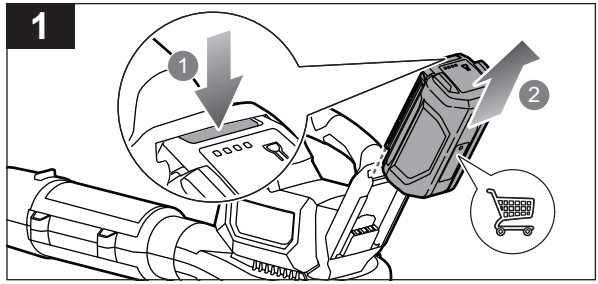

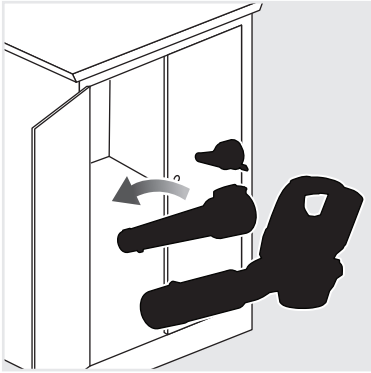

STORING THE PRODUCT

1. Press and hold the speed down or on/off button to turn off the product.
2. Press the latch and remove the battery pack.

NOTE: Push down the speed nozzle latch and remove the speed nozzle from the lower blower tube.

3. Pull up the tube latch and remove the lower blower tube from the product.
4. Store the product in a cool, dry, and well-ventilated place that is inaccessible to children and well away from sources of ignition.

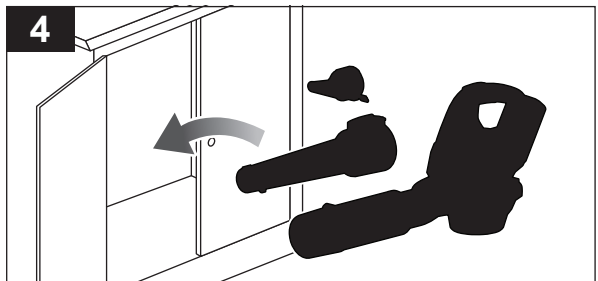
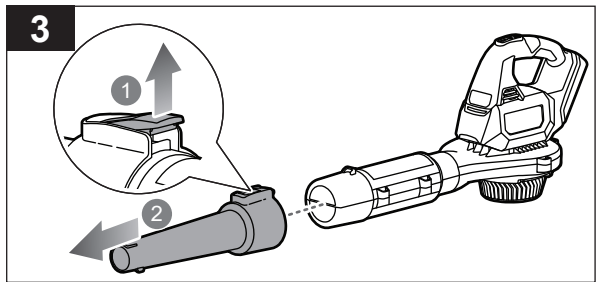
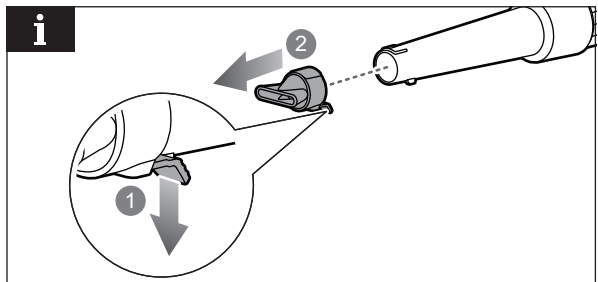
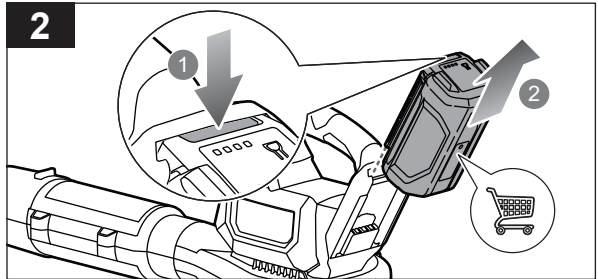
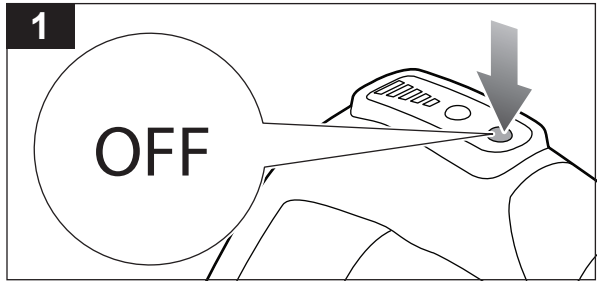

PRODUCT SPECIFICATIONS

Cordless blower	
Model	R36XBLWC0
Rated voltage	36 V d.c.
Rated current (5th speed setting)	13.42 A
Air velocity (5th speed setting)	307 km/h
Air volume (5th speed setting)	5.47 m ³ /min
Weight	
Without battery pack	1.98 kg
With heaviest battery pack	4.62 kg
Vibration level (in accordance with Annex BB of EN 50636-2-100)	
Total value ah	5.5 m/s ²
Uncertainty of measurement k	1.5 m/s ²
Noise emission level (in accordance with Annex CC of EN 50636-2-100)	
A-weighted sound pressure level at operator's position L_{pA}	90.2 dB(A)
Uncertainty of measurement k_{pA}	3.0 dB
A-weighted sound power level L_{wA}	100.6 dB(A)
Uncertainty of measurement k_{wA}	3.0 dB
$L_{wA} + K_{wA}$	104 dB(A)

BATTERY AND CHARGER

Model	R36XBLWC0	R36XBLWC4
Battery pack	-	R36BTY4
Charger	-	R36CHA4A0

Compatible battery packs

BPL3626D2, BPL3640D2, BPL3650D2, BPL3620D, BPL3660D, BPL3690D, BPL3612D, R36BTY2, R36BTY4, R36BTY5, RY36B50B, R36BTY6, RY36B60B, R36BTY8, RY36B80B, RY36B12A, R36BTY12

⚠ WARNING! The declared vibration total values and the declared noise emission values given in this instruction manual have been measured in accordance with a standardised test and may be used to compare one tool with another. They may be used for a preliminary assessment of exposure.

The declared vibration and noise emission values represent the main applications of the tool. However, if the tool is used for different applications, used with different accessories, or poorly maintained, the vibration and noise emission may differ. These conditions may significantly increase the exposure levels over the total working period.

An estimation of the level of exposure to vibration and noise should take into account the times when the tool is turned off or when it is running idle. These conditions may significantly reduce the exposure level over the total working period.

Identify additional safety measures to protect the operator from the effects of vibration and noise, such as maintaining the tool and the accessories, keeping the hands warm (in case of vibration), and organising work patterns.







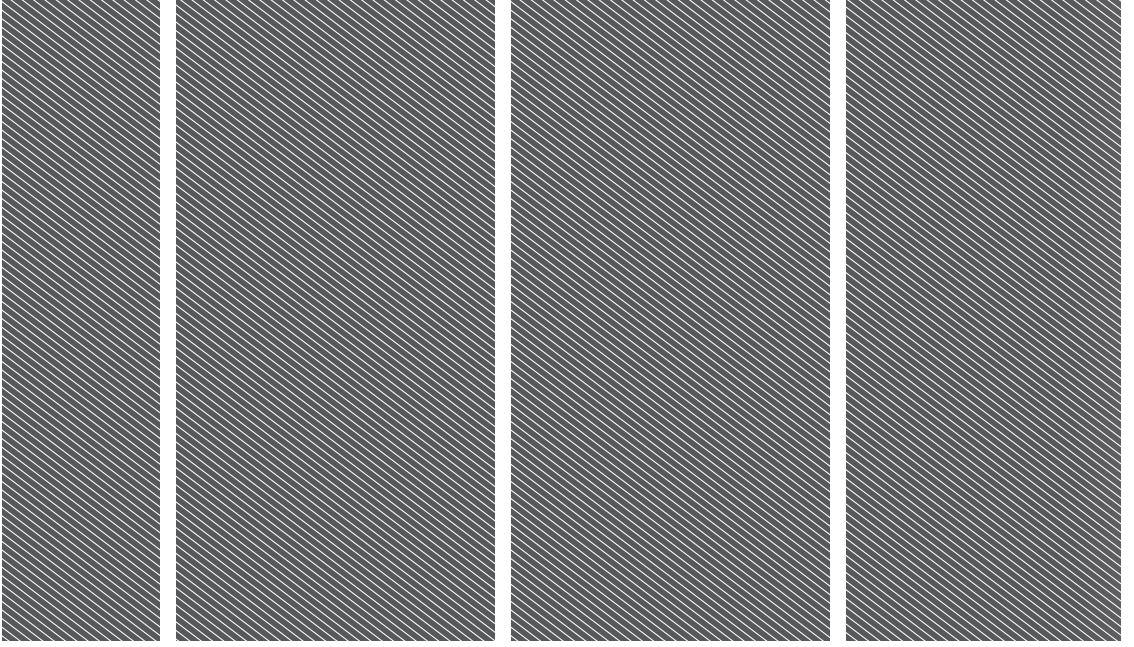

Imported by:
Techtronic Industries Australia Pty Ltd
31 Gilby Road, Mount Waverley, VIC 3149
Melbourne, Australia

Techtronic Industries N.Z. Limited
Unit C, 70 Business Parade South,
Highbrook, Auckland 2013, New Zealand

RYOBI is a trade mark of Ryobi Limited, and is used under license.

