

R18PHT120
R18PHTA20



IMPORTANT!

It is essential that you read the instructions in this manual before assembling, operating, and maintaining the product.

Subject to technical modification.

Safety, performance, and dependability have been given top priority in the design of your cordless pole hedge trimmer and pole hedge trimmer attachment.

INTENDED USE

The cordless pole hedge trimmer is intended only for outdoor use in dry and well-illuminated conditions.

The pole hedge trimmer attachment is approved for use with the battery-driven telescopic pole R18EZRPO.

It is intended to be used only by adults who have read and understood the instructions and warnings in this manual and relevant telescopic pole manual and can be considered responsible for their actions.

The product is designed for home or domestic use. The product is intended to cut and trim hedges, shrubs, and similar vegetation. The product is not intended for cutting hedges, shrubs, and similar vegetation with diameters greater than its cutting capacity.

The product is designed to be extended to a maximum length of 3.1 m (for assembling with battery-driven telescopic poles). Do not exceed this working length.

Do not use the product for any other purpose.

⚠ WARNING! The attachment is not suitable for use with telescopic poles equipped with a bike handle.

GENERAL PRODUCT SAFETY WARNINGS

⚠ WARNING! Read all safety warnings, instructions, illustrations and specifications provided with this power tool. Failure to follow all instructions listed below may result in electric shock, fire, and/or serious injury.

Save all warnings and instruction for future reference.

The term "power tool" in the warnings refers to your mains-operated (corded) product or battery-operated (cordless) product.

WORK AREA SAFETY

- **Keep work area clean and well lit.** Cluttered or dark areas invite accidents.
- **Do not operate power tools in explosive atmospheres, such as in the presence of flammable liquids, gases or dust.** Power tools create sparks which may ignite the dust or fumes.
- **Keep children and bystanders away while operating a power tool.** Distractions can cause you to lose control.

ELECTRICAL SAFETY

- **Power tool plugs must match the outlet. Never modify the plug in any way. Do not use any adapter plugs with earthed (grounded) power tools.** Unmodified plugs and matching outlets will reduce risk of electric shock.
- **Avoid body contact with earthed or grounded surfaces, such as pipes, radiators, ranges and refrigerators.** There is an increased risk of electric shock if your body is earthed or grounded.

- **Do not expose power tools to rain or wet conditions.** Water entering a power tool will increase the risk of electric shock.
- **Do not abuse the cord. Never use the cord for carrying, pulling or unplugging the power tool. Keep cord away from heat, oil, sharp edges or moving parts.** Damaged or entangled cords increase the risk of electric shock.
- **When operating a power tool outdoors, use an extension cord suitable for outdoor use.** Use of a cord suitable for outdoor use reduces the risk of electric shock.
- **If operating a power tool in a damp location is unavoidable, use a residual current device (RCD) protected supply.** Use of an RCD reduces the risk of electric shock.

PERSONAL SAFETY

- **Stay alert, watch what you are doing and use common sense when operating a power tool. Do not use a power tool while you are tired or under the influence of drugs, alcohol or medication.** A moment of inattention while operating power tools may result in serious personal injury.
- **Use personal protective equipment. Always wear eye protection.** Protective equipment such as a dust mask, non-skid safety shoes, hard hat or hearing protection used for appropriate conditions will reduce personal injuries.
- **Prevent unintentional starting. Ensure the switch is in the off-position before connecting to power source and/or battery pack, picking up or carrying the tool.** Carrying power tools with your finger on the switch or energising power tools that have the switch on invites accidents.
- **Remove any adjusting key or wrench before turning the power tool on.** A wrench or a key left attached to a rotating part of the power tool may result in personal injury.
- **Do not overreach. Keep proper footing and balance at all times.** This enables better control of the power tool in unexpected situations.
- **Dress properly. Do not wear loose clothing or jewellery. Keep your hair and clothing away from moving parts.** Loose clothes, jewellery or long hair can be caught in moving parts.
- **If devices are provided for the connection of dust extraction and collection facilities, ensure these are connected and properly used.** Use of dust collection can reduce dust-related hazards.
- **Do not let familiarity gained from frequent use of tools allow you to become complacent and ignore tool safety principles.** A careless action can cause severe injury within a fraction of a second.

POWER TOOL USE AND CARE

- **Do not force the power tool. Use the correct power tool for your application.** The correct power tool will do the job better and safer at the rate for which it was designed.
- **Do not use the power tool if the switch does not turn it on and off.** Any power tool that cannot be controlled with switch is dangerous and must be repaired.

- **Disconnect the plug from the power source and/ or remove the battery pack, if detachable, from the power tool before making any adjustments, changing accessories, or storing power tools.** Such preventive safety measures reduce the risk of starting the power tool accidentally.
- **Store idle power tools out of the reach of children and do not allow persons unfamiliar with the power tool or these instructions to operate the power tool.** Power tools are dangerous in the hands of untrained users.
- **Maintain power tools and accessories. Check for misalignment or binding of moving parts, breakage of parts and any other condition that may affect the power tool's operation. If damaged, have the power tool repaired before use.** Many accidents are caused by poorly maintained power tools.
- **Keep cutting tools sharp and clean.** Properly maintained cutting tools with sharp cutting edges are less likely to bind and are easier to control.
- **Use the power tool, accessories and tool bits etc. in accordance with these instructions, taking into account the working conditions and the work to be performed.** Use of the power tool for operations different from those intended could result in a hazardous situation.
- **Keep handles and grasping surfaces dry, clean and free from oil and grease.** Slippery handles and grasping surfaces do not allow for safe handling and control of the tool in unexpected situations.

BATTERY TOOL USE AND CARE

- **Recharge only with the charger specified by the manufacturer.** A charger that is suitable for one type of battery pack may create a risk of fire when used with another battery pack.
- **Use power tools only with specifically designated battery packs.** Use of any other battery packs may create a risk of injury and fire.
- **When battery pack is not in use, keep it away from other metal objects, like paper clips, coins, keys, nails, screws or other small metal objects, that can make a connection from one terminal to another.** Shorting the battery terminals together may cause burns or a fire.
- **Under abusive conditions, liquid may be ejected from the battery; avoid contact. If contact accidentally occurs, flush with water. If liquid contacts eyes, additionally seek medical help.** Liquid ejected from the battery may cause irritation or burns.
- **Do not use a battery pack or tool that is damaged or modified.** Damaged or modified batteries may exhibit unpredictable behaviour resulting in fire, explosion or risk of injury.
- **Do not expose a battery pack or tool to fire or excessive temperature.** Exposure to fire or temperature above 130°C may cause explosion.
- **Follow all charging instructions and do not charge the battery pack or tool outside the temperature range specified in the instructions.** Charging improperly or at temperatures outside the specified range may damage the battery and increase the risk of fire.

SERVICE

- **Have your power tool serviced by a qualified repair person using only identical replacement parts.** This will ensure that the safety of the power tool is maintained.
- **Never service damaged battery packs.** Service of battery packs should only be performed by the manufacturer or authorized service providers.

POLE HEDGE TRIMMER SAFETY WARNINGS

- **Keep all parts of the body away from the blade. Do not remove cut material or hold material to be cut when blades are moving.** Blades continue to move after the switch is turned off. A moment of inattention while operating the hedge trimmer may result in serious personal injury.
- **Carry the hedge trimmer by the handle with the blade stopped and taking care not to operate any power switch.** Proper carrying of the hedge trimmer will decrease the risk of inadvertent starting and resultant personal injury from the blades.
- **When transporting or storing the hedge trimmer, always fit the blade cover.** Proper handling of the hedge trimmer will decrease the risk of personal injury from the blades.
- **When clearing jammed material or servicing the unit, make sure all power switches are off and the battery pack is removed or disconnected.** Unexpected actuation of the hedge trimmer while clearing jammed material or servicing may result in serious personal injury.
- **Hold the hedge trimmer by insulated gripping surfaces only, because the blade may contact hidden wiring.** Blades contacting a "live" wire may make exposed metal parts of the hedge trimmer "live" and could give the operator an electric shock.
- **Keep all power cords and cables away from cutting area.** Power cords or cables may be hidden in hedges or bushes and can be accidentally cut by the blade.
- **Do not use the hedge trimmer in bad weather conditions, especially when there is a risk of lightning.** This decreases the risk of being struck by lightning.
- **To reduce the risk of electrocution, never use the extended-reach hedge trimmer near any electrical power lines.** Contact with or use near power lines may cause serious injury or electric shock resulting in death.
- **Always use two hands when operating the extended-reach hedge trimmer.** Hold the extended-reach hedge trimmer with both hands to avoid loss of control.
- **Always use head protection when operating the extended-reach hedge trimmer overhead.** Falling debris can result in serious personal injury.

ADDITIONAL SAFETY WARNINGS

- Some regions have regulations that restrict the use of the product to some operations. Check with your local authority for advice. Read all instructions.
- Check the hedges and bushes for foreign objects, such as wire fences and hidden wiring.
- While operating the product, always hold it firmly with both hands by the two handles.
- Use the product only at ground level and not on any other unstable support.

- Inspect the product before each use. Check for loose fasteners, etc. Make sure that all guards and handles are properly and securely attached. Replace any damaged parts before use. Check for battery pack leaks.
- Check that all the shaft couplings on the extension shaft and tool are securely fastened before each use and at frequent intervals.
- Use the harness if it is supplied with the product. It will assist you to support the weight of the product during use and while moving between trimming positions. Carefully adjust the harness to fit comfortably.
- Identify the quick-release mechanism and practice using it before you start using the product. Its correct use may prevent serious injury in the case of an emergency. Never wear additional clothing over the harness or otherwise restrict access to the quick-release mechanism.
- Do not operate the product in poor lighting. The operator requires a clear view of the work area to identify potential hazards.
- The use of hearing protection reduces the ability to hear warnings (shouts or alarms). The operator must pay extra attention to what is going on in the working area.
- Operating similar tools nearby increases both the risk of hearing injury and the potential for other persons to enter your working area.
- Turn off the product, remove the battery pack, and allow both to cool down. Make sure that all moving parts have come to a complete stop:
 - before adjusting the working position of the cutting means
 - before servicing
 - before clearing a blockage
 - before checking, cleaning, or working on the product
 - before changing accessories
 - before leaving the product unattended
 - before checking for damage after striking a foreign object
 - before performing maintenance
 - whenever the product starts to vibrate abnormally
- Do not force the product through heavy shrubbery. This can cause the blades to bind and slow down. If the blades slow down, reduce the pace.
- If the product is dropped, suffers heavy impact, or begins to vibrate abnormally, immediately turn off the product and inspect it for damage or identify the cause of the vibration. Any damage should be properly repaired or replaced by an authorised service centre.
- Do not wear multiple belt or shoulder harnesses.
- Do not modify the product in any way.
- Operate the product only in temperatures between 0°C and 40°C.
- Store the product in a location where the ambient temperature is between 0°C and 40°C.
- Injuries may be caused, or aggravated, by prolonged use of the product. When using any product for prolonged periods, ensure to take regular breaks.

ADDITIONAL BATTERY SAFETY WARNINGS

- To reduce the risk of fire, personal injury, and product damage due to a short circuit, never immerse the tool, battery pack, or charger in fluid or allow fluid to flow

inside them. Corrosive or conductive fluids, such as seawater, certain industrial chemicals, and bleach or bleach-containing products, etc., can cause a short circuit.

- Charge the battery pack in a location where the ambient temperature is between 10°C and 38°C.
- Store the battery pack in a location where the ambient temperature is between 0°C and 20°C.
- Use the battery pack in a location where the ambient temperature is between 0°C and 40°C.

TRANSPORTATION AND STORAGE

- Turn off the product, remove the battery pack, and allow both to cool down before storing or transporting.
- Remove all foreign materials from the product. Store the product in a cool, dry, and well-ventilated area that is inaccessible to children. For extra safety, store the battery pack separately from the product. Keep the product away from corrosive agents, such as garden chemicals and de-icing salts. Do not store the product outdoors.
- Fit the blade cover before storing the product or during transportation.
- For transportation, secure the product against movement or falling to prevent injury to persons or damage to the product.

TRANSPORTING LITHIUM BATTERIES

Transport the battery in accordance with local and national provisions and regulations.

Follow all special requirements on packaging and labelling when transporting batteries by a third party. Ensure that no batteries can come in contact with other batteries or conductive materials while in transport by protecting exposed connectors with insulating, non-conductive caps or tape. Do not transport batteries that are cracked or leaking. Check with the forwarding company for further advice.

MAINTENANCE

- Use only original manufacturer's replacement parts, accessories, and attachments. Failure to do so can cause possible injury, can contribute to poor performance, and may void your warranty.
- Servicing requires extreme care and knowledge and should be performed only by a qualified service technician. Have the product serviced by an authorised service centre only.
- The blades are extremely sharp. To prevent personal injury, exercise extreme caution when cleaning, lubricating, fitting, or removing the blade cover.
- Remove the battery pack before adjusting, maintaining, or cleaning the product.
- You may make adjustments and repairs described in this manual. For other repairs, have the product serviced by an authorised service centre only.
- After each use, clean the plastic parts with a soft, dry cloth.
- After each use, clean the debris from the blades with a stiff brush, and then carefully apply a rust preventative lubricant before refitting the blade protector. The manufacturer recommends using rust preventative lubricant spray to apply an even distribution and reduce

the risk of personal injury from contact with the blades. For information about a suitable spray product, check with an authorised service centre.

- Check all nuts, bolts, and screws at frequent intervals for proper tightness to ensure that the product is in safe working condition. Any part that is damaged should be properly repaired or replaced by an authorised service centre.

SYMBOLS ON THE PRODUCT



Safety alert



Read and understand all instructions before operating the product. Follow all warnings and safety instructions.



Wear eye, ear, and head protection.



Do not expose the product to rain or damp conditions.



To prevent serious injury, do not touch the cutting blades.



Wear non-slip, heavy-duty protective gloves.



Wear non-slip safety footwear when using the product.



Regulatory Compliance Mark (RCM). The product meets applicable regulatory requirements.



Keep sufficient distance away from electrical power lines.



Beware of thrown or flying objects. Keep all bystanders, especially children and pets, at least 15 m away from the operating area.



Guaranteed sound power level



Waste electrical products should not be disposed of with household waste. Please recycle where facilities exist. Check with your local authority or retailer for recycling advice.

SYMBOLS IN THIS MANUAL



Parts or accessories sold separately



Note



Warning



Lock



Unlock

R18PHT120

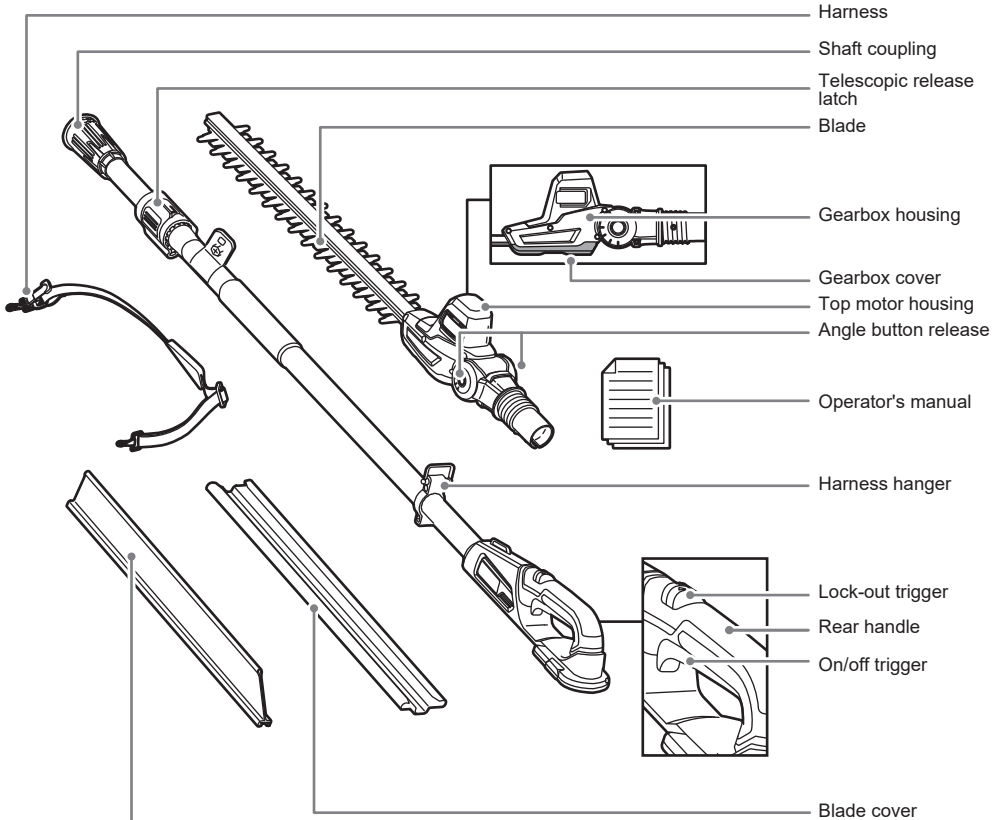

HEDGESWEEP debris sweeper

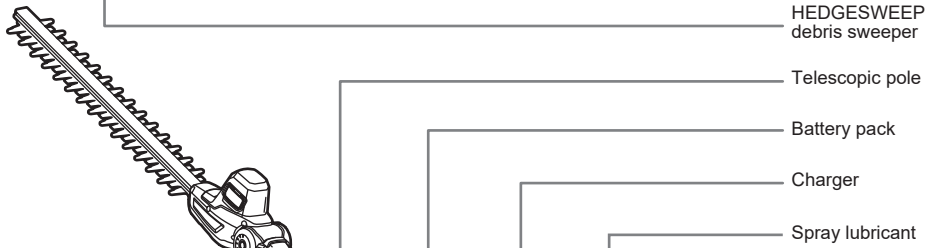

R18PHTA20

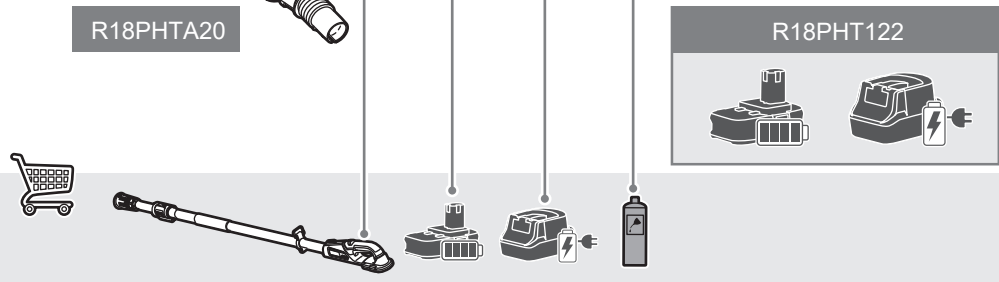

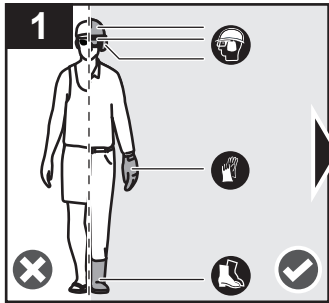

Always wear eye, ear, and head protection while operating the product. Wear non-slip, heavy-duty protective gloves. Wear non-slip safety footwear when using the product.

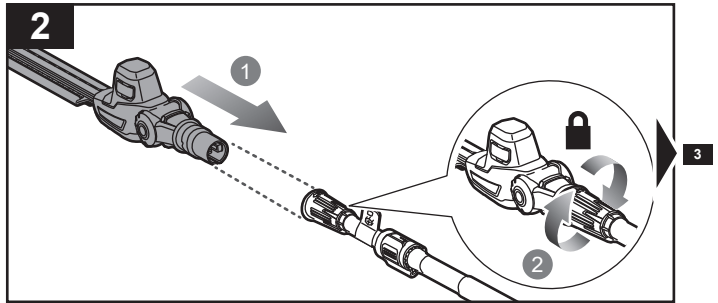

Attach the pole hedge trimmer attachment to the pole. Turn the shaft coupling clockwise to tighten.

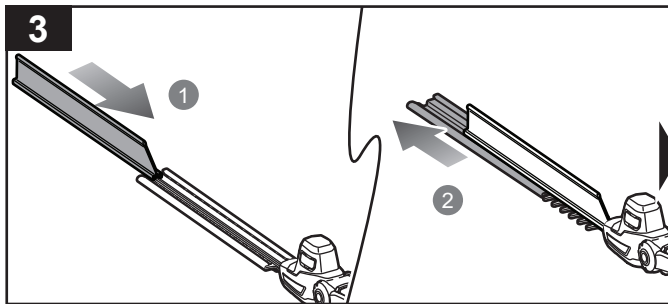

Slide the HEDGESWEEP debris sweeper over the blade. Remove the blade cover.

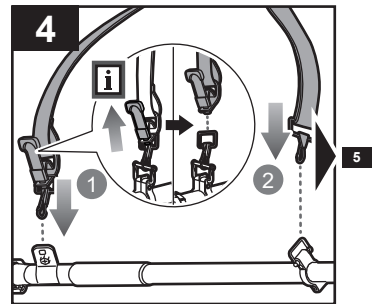

Attach the harness to the harness hanger.

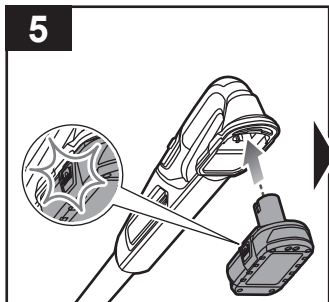

Install the battery pack. Make sure that the latches on the battery pack click into place.

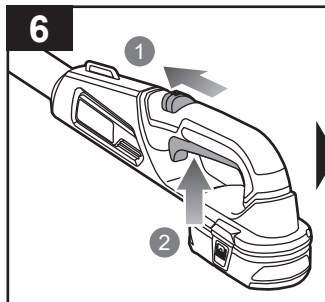

Slide the lock-out trigger forward, and squeeze the on/off trigger to turn on the product.

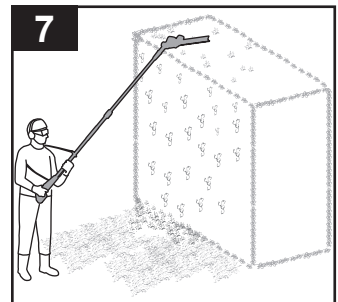

Begin trimming the hedge from right to left.

Operating the product **p.9**

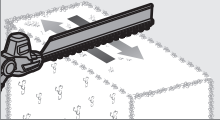

R18PHTA20 R18PHT120

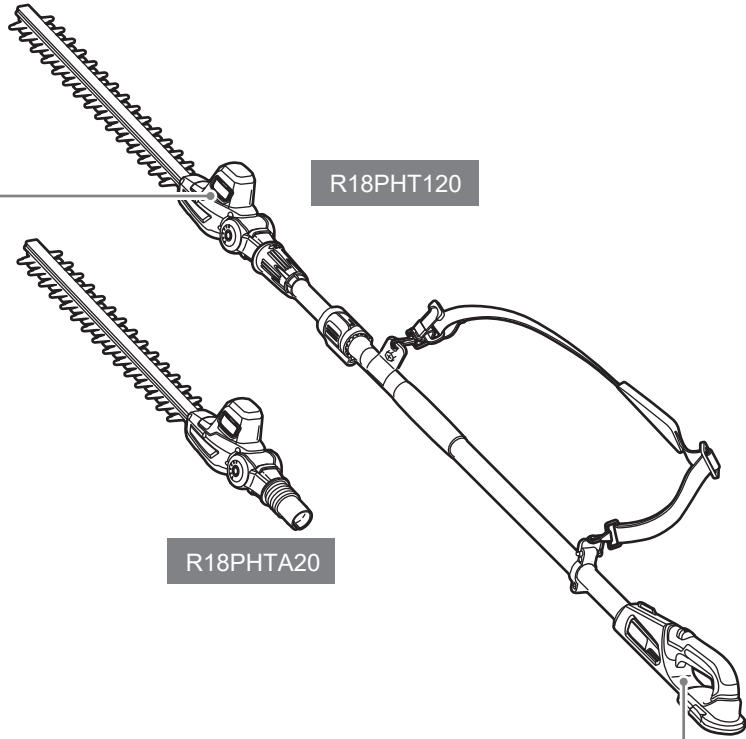

Cleaning the product **p.12**

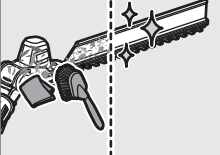

Installing the blade **p.15**

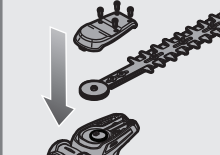

Removing the blade **p.13**

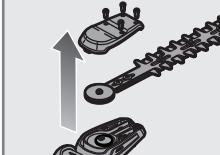

Storing the product **p.17**

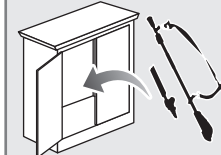

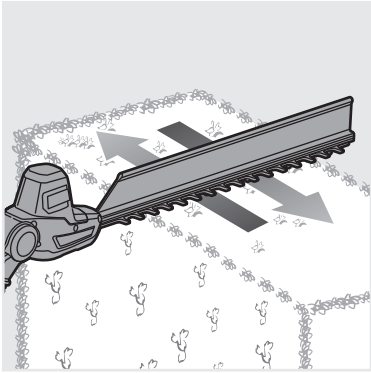

OPERATING THE PRODUCT

DANGER! Risk of electrocution! Do not operate within 10 m of overhead electrical lines.

Position the product at an angle of 60° or less, depending on the specific situation. Keep bystanders at least 15 m away.

CAUTION: Always use two hands to operate the product.

WARNING: Hold the product by the rear handle and foam grip of the telescopic pole only.

1. Press the latches on the battery pack, and remove the battery pack from the product.
2. Install the blade cover.

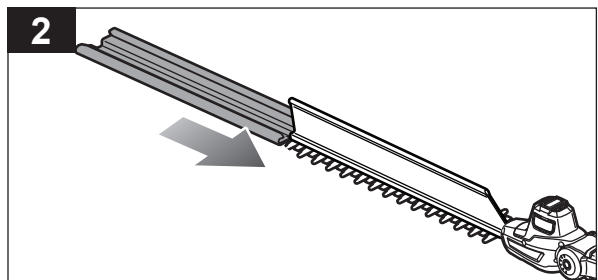
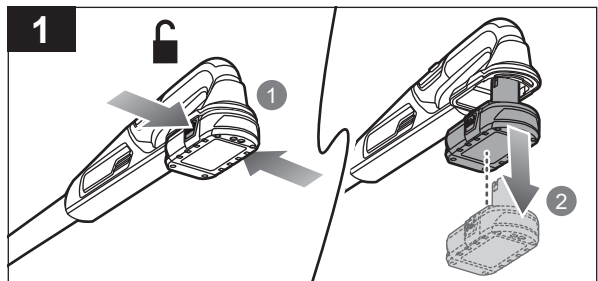
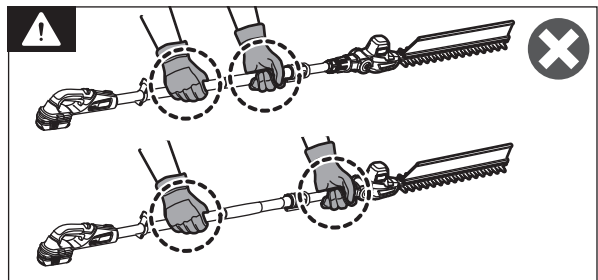
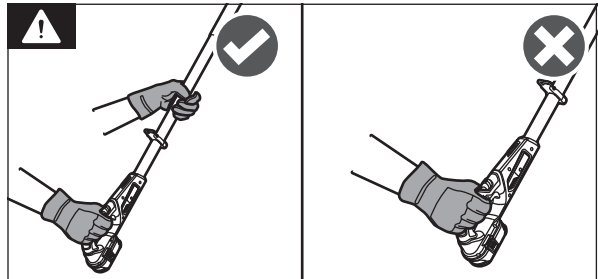
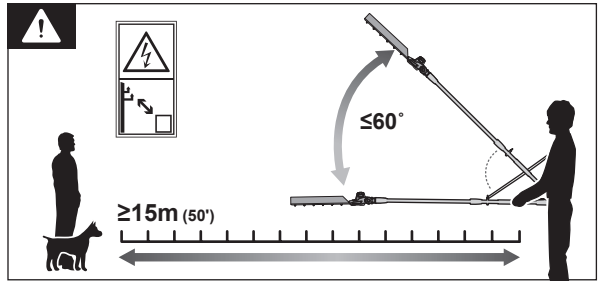

3. Lay the product on the ground.

WARNING: Keep bare hands away from the blades at all times.

4. Press the angle button release and adjust the pole to the required working angle.

WARNING: Do not touch the blade to adjust the working angle.

NOTE: The working angle of the pole hedge trimmer can be adjusted to -60° , -30° , 0° , 30° , 60° , and 90° .

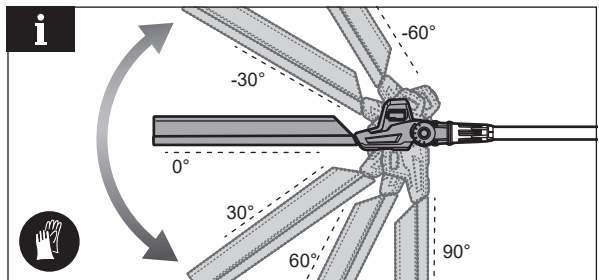
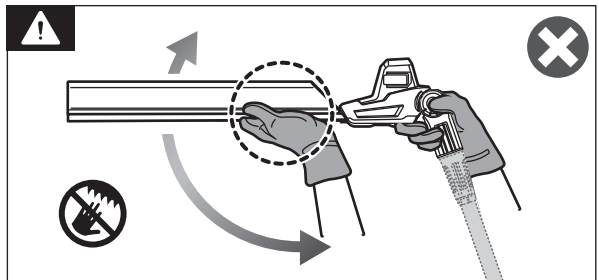
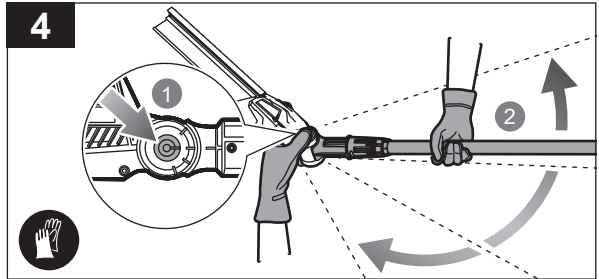
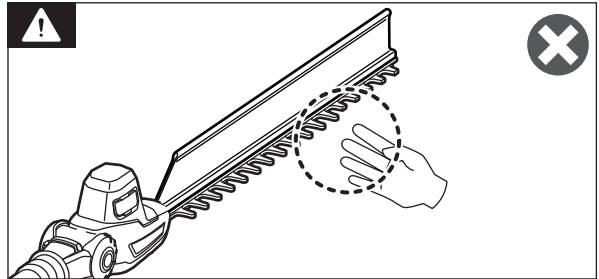
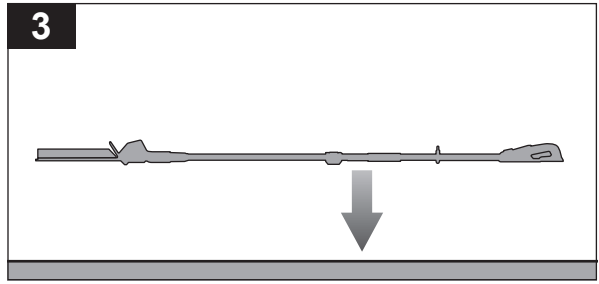

5. Remove the blade cover.
6. Install the battery pack. Make sure that the latches on the battery pack click into place.
7. Unlock the telescopic release latch. Adjust the pole length according to the required release working height. Lock the telescopic release latch. Make sure that the latch clicks into place.
8. Slide the lock-out trigger forward, and squeeze the on/off trigger to turn on the product.
9. Begin trimming the hedge from right to left.

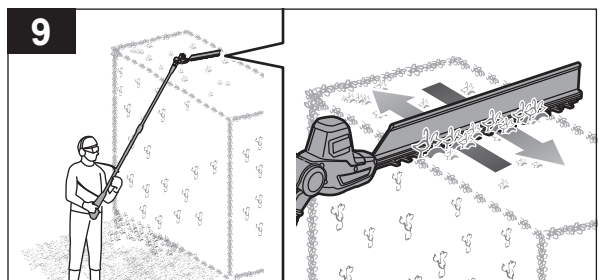
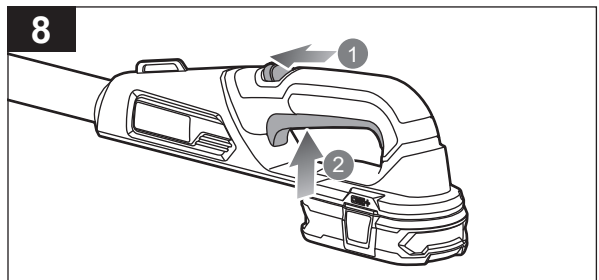
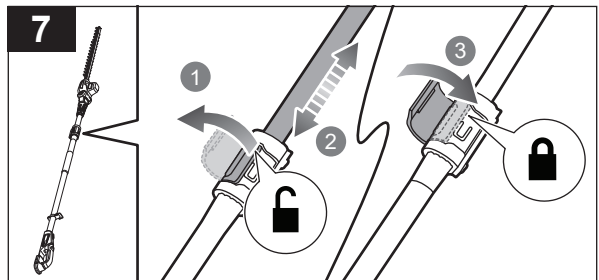
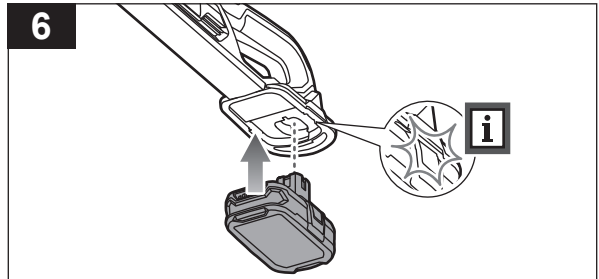
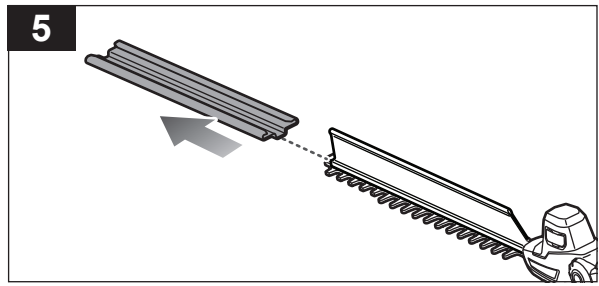

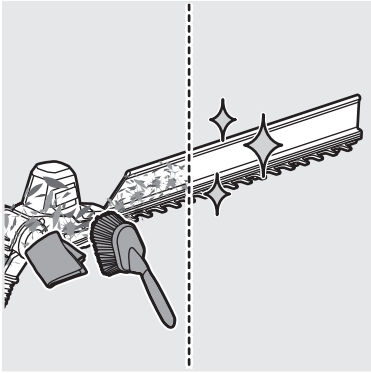

CLEANING THE PRODUCT

1. Press the latches on the battery pack and remove the battery pack from the product.
2. Remove the HEDGESWEEP debris sweeper. Clean the HEDGESWEEP debris sweeper and body and handles of the product with a soft, dry cloth. Clean the blades with a stiff brush.

WARNING: Do not use water to clean the product.

3. Lubricate the blades lightly before and after use with a plant-friendly lubricant.

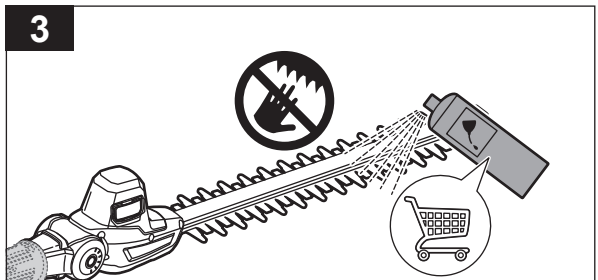
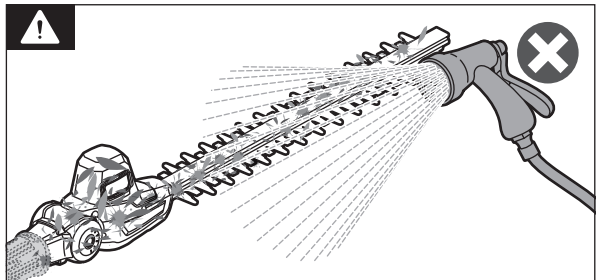
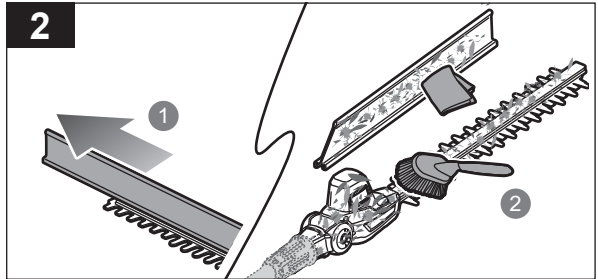
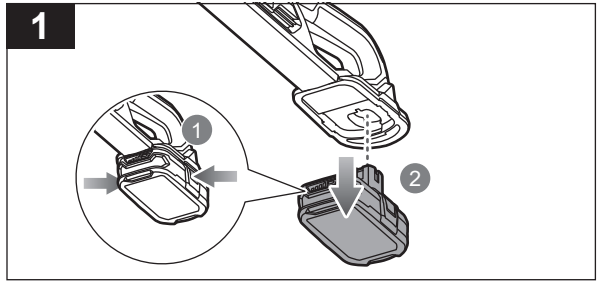

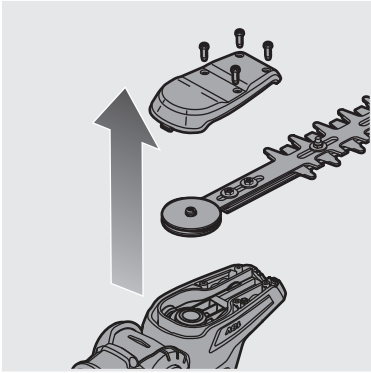

REMOVING THE BLADE

1. Press the latches on the battery pack and remove it from the product.
2. Turn the pole hedge trimmer attachment upside down.
3. Turn the gearbox cover screws counterclockwise to loosen them.
4. Remove the gearbox cover screws and gearbox cover.
5. Turn the blade shaft screws counterclockwise to loosen them using a socket wrench.

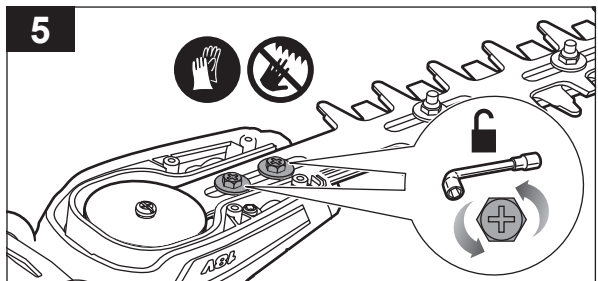
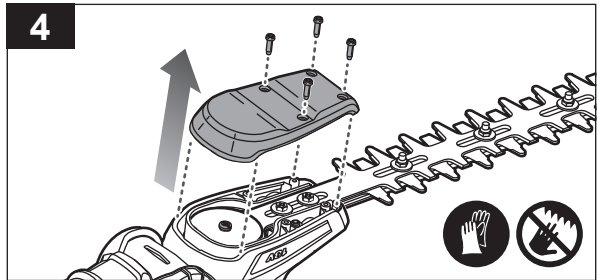
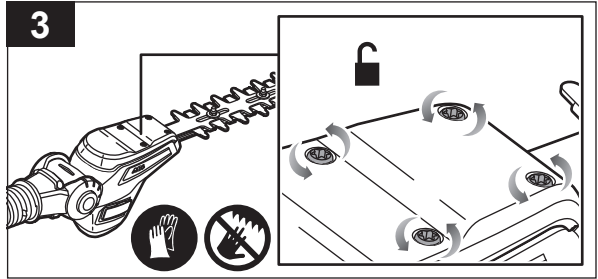
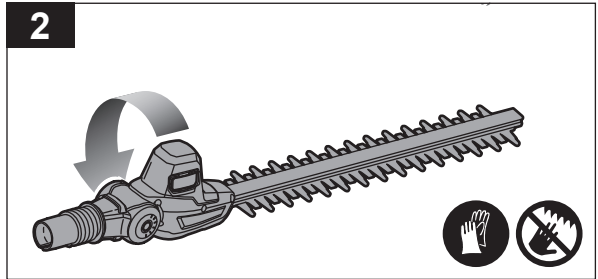
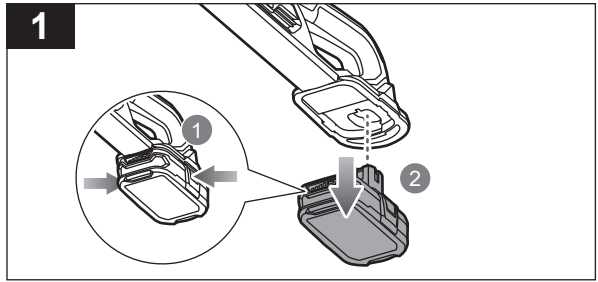

6. Remove the blade shaft screws and blade shaft washers from the blade.
7. Remove the blade from the pole hedge trimmer attachment.

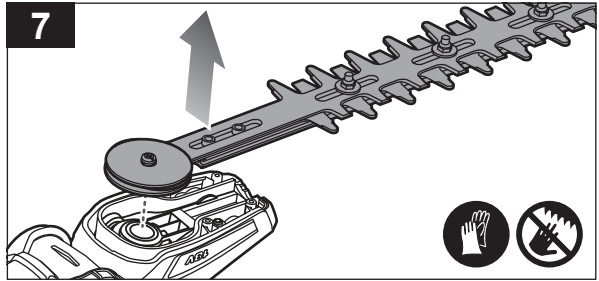
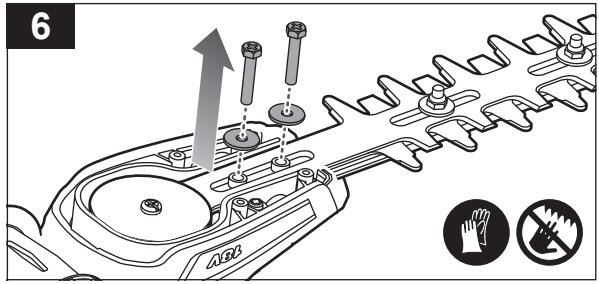

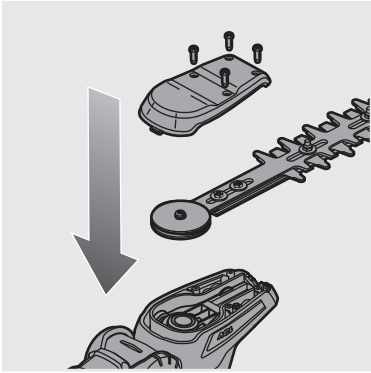

INSTALLING THE BLADE

1. Install the blade to the pole hedge trimmer attachment.
2. Install the blade shaft washers and blade shaft screws to the blade.
3. Turn the blade shaft screws clockwise to tighten them using a socket wrench.
NOTE: Do not overtighten the screws. The torque setting is 0.98-1.77 Nm.
4. Install the gearbox cover and gearbox screws to the pole hedge trimmer attachment.
5. Turn the gearbox screws clockwise to tighten them.

NOTE: Do not overtighten the screws. The torque setting is 0.98-1.77 Nm.

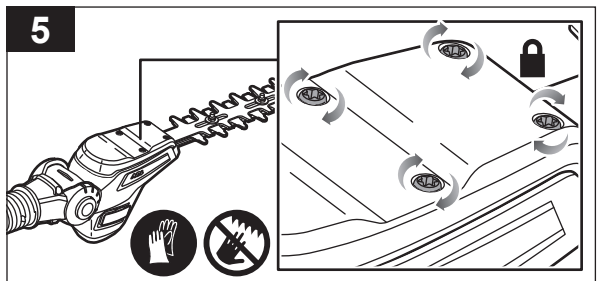
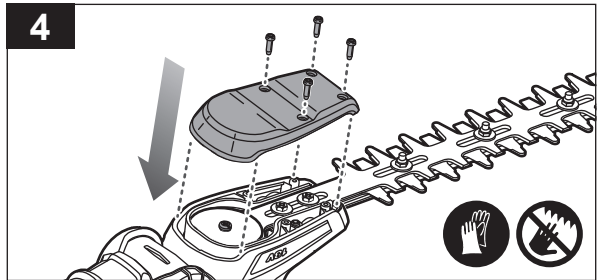
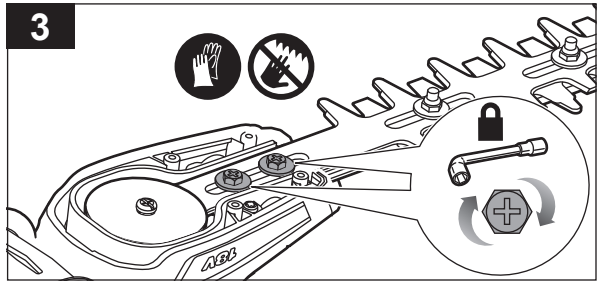
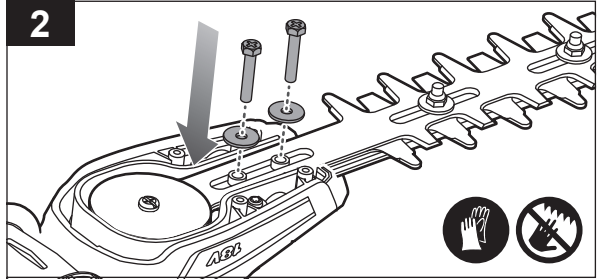
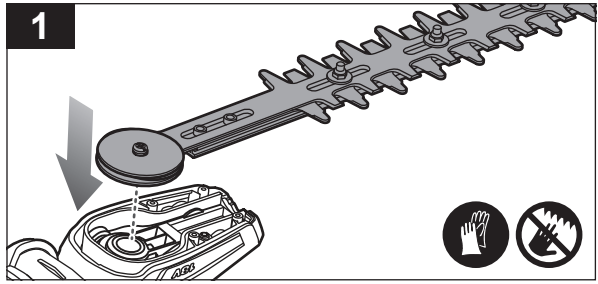

6. Turn the pole hedge trimmer attachment right-side up.

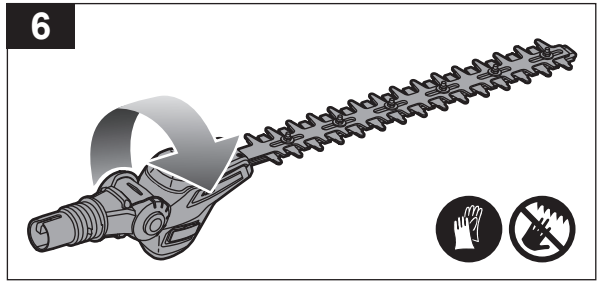

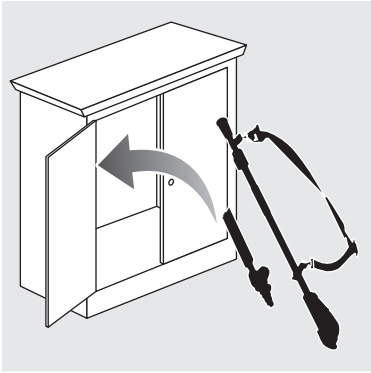

STORING THE PRODUCT

WARNING: Make sure that the product is clean before storing.

1. Press the latches on the battery pack, and remove the battery pack from the product.
2. Install the blade cover.
3. Turn the shaft coupling counterclockwise, and remove the pole hedge trimmer attachment from the pole
4. Store the product in a cool, dry, and well-ventilated place that is inaccessible to children and well away from sources of ignition.

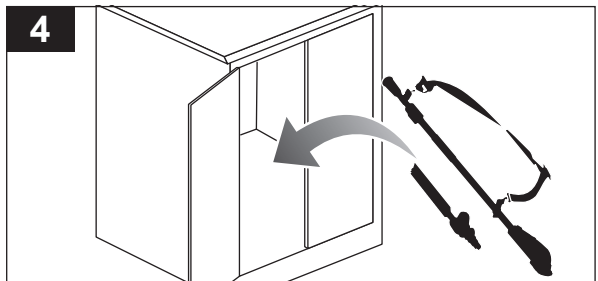
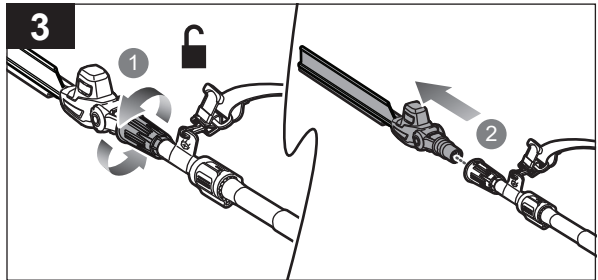
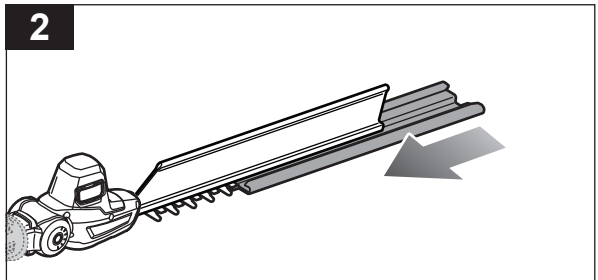
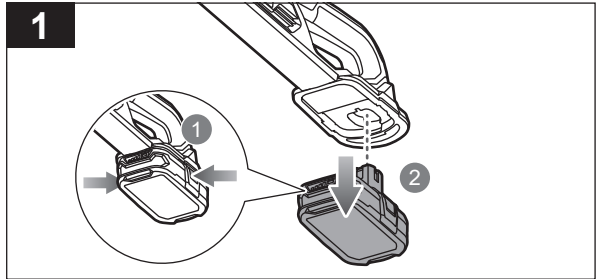
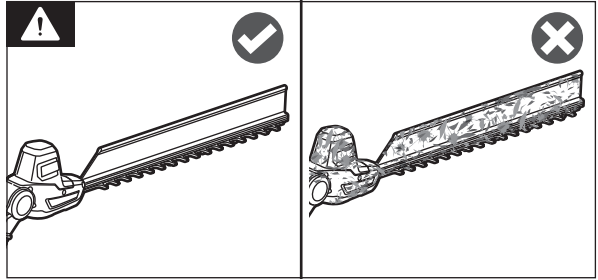

PRODUCT SPECIFICATIONS

Cordless pole hedge trimmer	
Model	R18PHT120
Rated voltage	18 V d.c.
No-load speed	2600 spm
Blade length	400 mm
Cutting capacity	16 mm
Vibration level (in accordance with EN 62841-1 and EN 62841-4-2)	
Front handle	1.2 m/s ²
Rear handle	1.0 m/s ²
Uncertainty of measurement	1.5 m/s ²
Noise emission level (in accordance with EN 62841-1 and EN 62841-4-2)	
A-weighted sound pressure level	79.3 dB(A)
Uncertainty of measurement	3 dB
A-weighted sound power level	87.3 dB(A)
Uncertainty of measurement	3 dB
Weight (without battery pack)	3.3 kg
Weight (with heaviest battery pack)	4.5 kg
Pole hedge trimmer attachment	
Model	R18PHTA20
Blade length	400 mm
Cutting capacity	16 mm
Maximum product working length	3.1 m
Weight	1.36 kg
For assembling with battery-driven telescopic pole (below values measured with R18EZRPO telescopic pole)	
Rated voltage	18 V d.c.
No-load speed	2600 spm
Weight (with telescopic pole and without harness)	3.2 kg
Vibration level (in accordance with EN 62841-1 and EN 62841-4-2)	
Front handle	1.2 m/s ²
Rear handle	1.0 m/s ²
Uncertainty of measurement	1.5 m/s ²
Noise emission level (in accordance with EN 62841-1 and EN 62841-4-2)	
A-weighted sound pressure level	79.3 dB(A)
Uncertainty of measurement	3 dB
A-weighted sound power level	87.3 dB(A)
Uncertainty of measurement	3 dB

BATTERY AND CHARGER

Model	R18PHT122	R18PHT120
Battery pack	RB1820C	-
Charger	RC18115	-
Compatible battery packs	RB18L13, RB18L26, RB18L15, RB18L15A, RB18L15B, RB18L20, RB18L20A, RB18L13, RB18L13Z, RB18L25, RB18L25A, RB18L40, RB18L40A, RB18L50, RB18L50A, RB18L30, RB18L30A, RB18L60, RB18L60A, RB18L90, RB18L90A, RB1840T, RB18L25, RB18L40, RB18L40A, RB18L50, RB1815C, RB1820C, RB1825C, RB1840C, RB1840X, RB1850C, RB1850X, RB1860X	

NOTE: Visit your local special orders desk or contact RYOBI customer service for replacement parts.

⚠ WARNING! The declared vibration total values and the declared noise emission values given in this instruction manual have been measured in accordance with a standardised test and may be used to compare one tool with another. They may be used for a preliminary assessment of exposure.

The declared vibration and noise emission values represent the main applications of the tool. However, if the tool is used for different applications, used with different accessories, or poorly maintained, the vibration and noise emission may differ. These conditions may significantly increase the exposure levels over the total working period. An estimation of the level of exposure to vibration and noise should take into account the times when the tool is turned off or when it is running idle. These conditions may significantly reduce the exposure level over the total working period.

Identify additional safety measures to protect the operator from the effects of vibration and noise, such as maintaining the tool and the accessories, keeping the hands warm (in case of vibration), and organising work patterns.



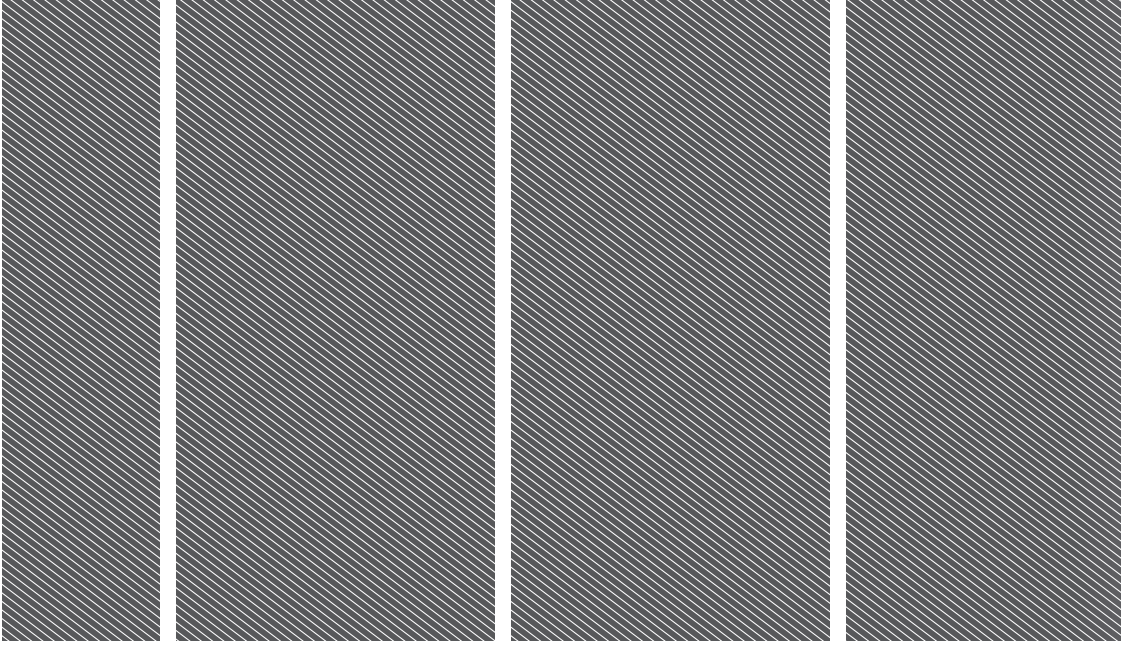

Imported by:

Techtronic Industries Australia Pty Ltd

31 Gilby Road, Mount Waverley, VIC 3149

Melbourne, Australia

Techtronic Industries N.Z. Limited

Unit C, 70 Business Parade South,

Highbrook, Auckland 2013, New Zealand

RYOBI is a trade mark of Ryobi Limited, and is used under license.

HEDGESWEEP is a trade mark of Techtronic Outdoor Products Technology Limited.

961476030-02

