

BELLESSI | BELLESSI MOTIV

—
SPLASHBACKS FOR KITCHEN,
BATHROOM & LAUNDRY

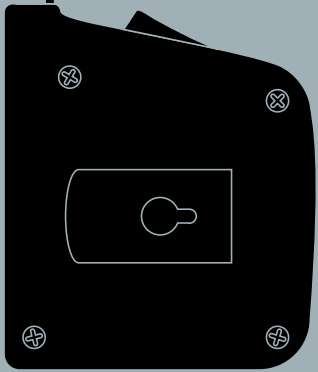

bellessi

Installation

Instructions

Manufactured in Australia by:



1/37 Hosie Street, Bayswater VIC AUS 3153
Telephone: (613) 9729 4999
Facsimile: (613) 9729 5197
Email: cme@composite.com.au



Tools to Assist with Installation

Marker

Straight Edge

Tape Measure

Carpenters Square

Caulking Gun

Circular Saw

Drill

Trestle Table or Work Bench

Sanding Block

Wet and dry sand papers

Neutral cure translucent silicone

Double Sided tape

4mm Tile Spacers

Appropriate task related PPE
(Personal Protective Equipment)

Warnings

Bellessi is not to be used in direct contact with any heat source above 80° C.
— See *heat tolerance section for additional advice.*

Please inspect every sheet of Bellessi before installation for any imperfections or colour batch issues as these will not be covered under warranty after installation.

Ensure Painted side is installed against the wall.

Bellessi panels are not suitable as a wall finish panel behind gas cook tops. They can be used as a splashback behind electric, induction and ceramic cook tops with a minimum clearance of 50mm between the rear edge of the cook tops and the face of the Bellessi panel.

Do not use a knife to open the carton your Bellessi panel comes in as you can damage your panel with cutting implements when opening.

Bellessi is for use as an internal decorative panel only and not suitable for use outdoors.

Your Bellessi panel will expand and contract with temperature fluctuations, always ensure expansions gaps are allowed around the perimeter of each panel.

Bellessi panels must always be stored inside and lied flat to prevent any potential bowing of the sheet.

Technical Support

It is not practical to describe every possible application for Bellessi in this document.

This document is a guideline for installing Bellessi and will not wear any liability for waterproofing which should be installed to the current Australian Standard.

For technical help please contact Bellessi on 1800 45 47 44.

An Introduction to Bellessi

Bellessi is an Australian made high gloss decorative panel system that is manufactured exclusively for Bunnings. Bellessi can be used in all areas across your home—kitchens, bathrooms, laundries—*almost any vertical surface!*

Area Preparation

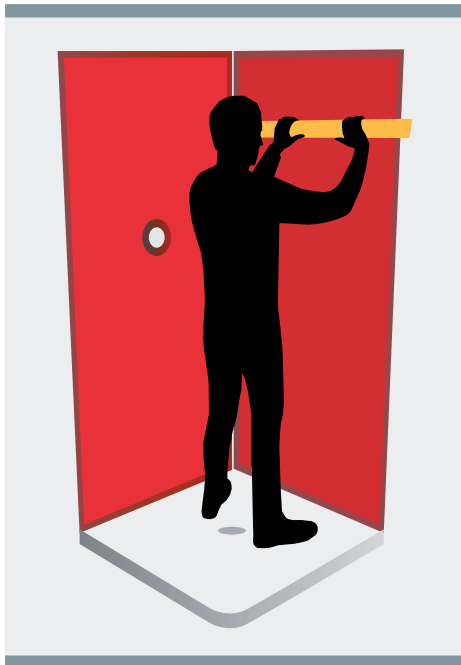

Hint—
Use a straight edge to press Bellessi onto the wall to ensure a flat finish

Always ensure your walls are clean, dry, smooth and free from any foreign materials.

Ensure any fixings used to hold the backing substrate that is behind your Bellessi panel are recessed or flush to prevent damage to your colour back by screw heads or nails etc.

All backing substrates should be flush with no lipping or steps across different sheets.

Where you are installing your Bellessi panel over existing tiles ensure they are structurally sound with no loose tiles. Where you have loose tiles remove completely and fill void with an appropriate filler. Clean all tiles thoroughly with a grease removing cleaner like sugar soap to remove any contaminants. Extremely high gloss tiles may need to be scuffed with coarse sandpaper to ensure correct adhesion with your silicone (see silicone manufacturers recommendations).

A suggestion is when installing multiple panels determine where your joins will be and identify the area that may be visible between these joins with your marker. A good idea is to paint the back wall with a similar colour paint as to your Bellessi panel to help reduce the visibility of your join.

Handy Hints

Once you have completed all preparation and cutting don't forget to remove the protective film on the back (painted) side of your panel before adhering to your wall

Always leave the front protective film on the front of your panel until the very last. This should be the last job after you have cleaned up your construction site.

When pushing your panel against a wall use a straight edge as this will ensure you have a nice flat installation rather than one that follows the contour of an uneven wall.

Use the packaging your panel came in to make up a template for cutting your sheet.

Use tile spacers to give you the correct spacing between sheets and your bench top

Masking tape on the painted back of your sheet where a hole is to be drilled can help prevent starring and damaging the paint.

When cutting your Bellessi panel always cut through into a sacrificial board as this will help prevent vibration and chatter when cutting.

You can use small pieces of double sided tape to hold your panel in place while your silicone cures.

Bellessi Kitchen Splashbacks

Herat Tolerance

Induction

Figure 2

Bellessi can be used directly behind induction cook tops, reducing time and hassles associated with colour back glass.

Electric | Ceramic Cooktops

Figure 2

Bellessi can be used directly behind electric and ceramic cook tops when covered with cookware. An exposed cook top emits far greater radiant heat than when covered and this can damage your splashback. Therefore Bellessi is only covered under warranty against normal wear and tear.

Heat tolerance

Figure 1

Do not leave your hot plate unattended. Radiant heat will damage your Bellessi splashback and will void warranty.

Gas Cooktops

Figure 3

Bellessi must be used behind gas cooktops in conjunction with a non combustible materials such as glass, tiles or stainless steel.

Bellessi requires a minimum 150mm up stand behind the gas cooktop to comply with Australian standards. Bellessi can be used above the 150mm non-combustible up stand. Alternatively stainless steel, glass or tiles can run all the way to the range hood.

Fig. 1

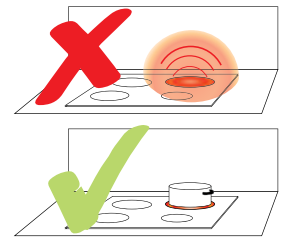

Fig. 2

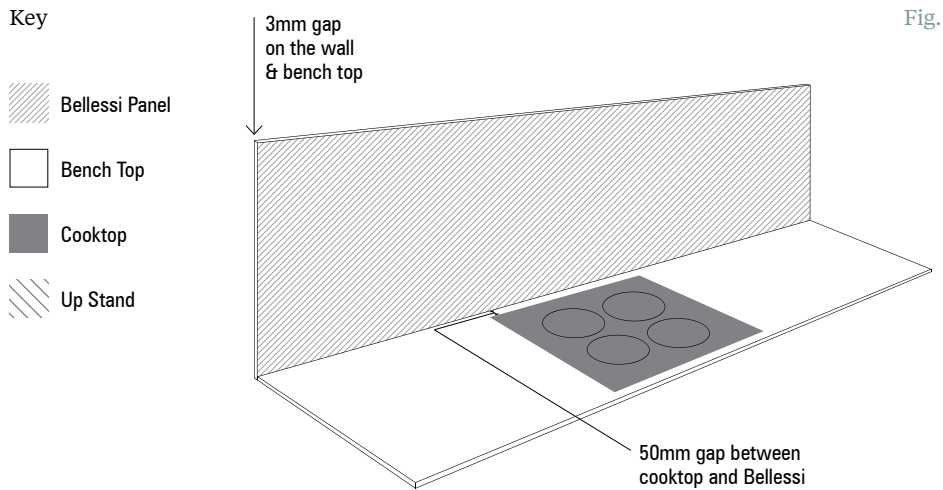
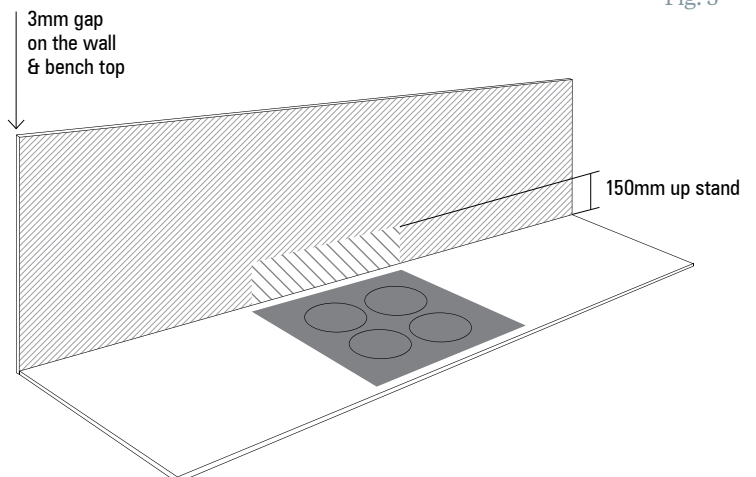

Fig. 3



Cutting Your Bellessi Panel

Circular Saw

Always cut Bellessi on a flat secured surface. (Figure 5)

With quality equipment, an excellent edge finish can be achieved with Bellessi. The main factors in achieving the best possible outcome with a circular saw are:

Panel rigidity. Clamp the sheet on both sides of the cut.

Saw stability. Always use a good quality fence or guide to improve saw stability and straight-line cutting.

Saw bearing quality. The price of a circular saw can be a good indication of the quality of the bearings used inside. Cheaper saws often use bushes that offer little to limit the blade's sideways float, and will begin to wear quickly. This will have a dramatic impact on cut quality.

Blade selection. Always use a blade with the correct cutting geometry. Aluminum blades generally work well with Bellessi.

Circular Blade Geometry and Conditions

Circular Blades for Bellessi.

Bellessi is best cut using fine-tooth Aluminum circular blades with either a "hollow ground" geometry or a "triple chip" blade with the following geometry and conditions;

Blade Diameter (mm)	255–305
Number of Teeth	80–100
Tooth Thickness (mm)	3–3.5
Clearance Angle	15–20°
Cutting Angle (Rake)	-5°
Cutting Angle of Setting Band	2–3°
Blade Speed (rpm)	3k–5k
Surface Speed (m/min)	3k–4k

Hole Saws

Hole saws should be sharp, but the pilot drill blunt. It is recommended to drill the hole saw half way through, then turn the Bellessi over and finish the hole.

This prevents the edge from "blowing out". De-bur the edge with 100-grit sandpaper.

Cutting of Penetrations

When measuring and marking for cut-outs around power outlet boxes etc, ensure enough clearance is given for the switch body and that the cover plates or bulkhead fittings will cover the finished cut-outs.

Use an approved sealer to seal the edge and a 50mm perimeter of the painted side of any Cut Outs.

Drilling Bellessi with a Blunt Drill Bit

Figure 4

Bellessi can be drilled using any normal drill bit that is slightly blunt. You can blunt a drill bit by first rubbing the tip with a coarse sand paper.

Alternatively you can use a Sutton Multi Purpose drill bit on a slow speed; being particularly careful to reduce the speed as you pass through the other side of your sheet of Bellessi.

Fig. 4



Reduce the cutting depth to allow the blade to cut approximately 7mm through the Bellessi, preferably cutting into a sacrificial MDF board or similar.

Support Bellessi Panel back on plywood or MDF sheet or solid work top.

Fig. 5

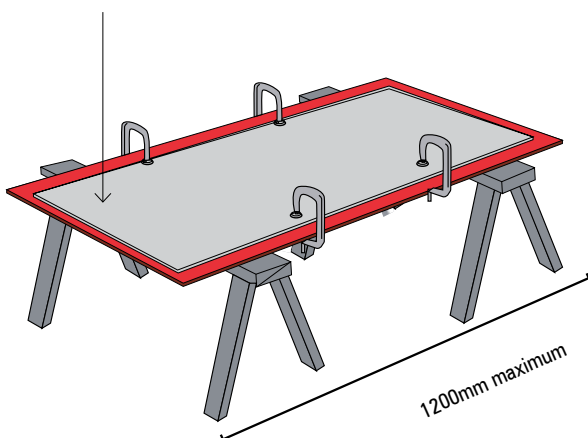

What Adhesive do I Use?

Bellessi recommend the use of Fuller HBF660, Bostik V60 neutral cure translucent silicone when sealing and adhering your panels to the wall and sealing between them. Only premium quality neutral cure translucent silicones should be used, this will ensure there is no bleed through the painted finish.

Always follow the adhesive manufacturers instructions when using silicones in wet areas. The use of non recommended or lower quality silicones will void your warranty. Always ensure to test your silicone in an inconspicuous area as silicones can contain fillers that may damage your Bellessi panel.

Figure 1
Bellessi recommends the following procedure when installing your panel behind electric cooktops. For areas around your cook top apply a 6mm thick bead of silicone vertically every 100mm the length of the panel. For directly behind your cook top apply 6mm bead of silicone vertically every 20mm the full width to a height of 350mm. When pressing your panel to the wall with your straight edge use enough force to compress the 6mm thick beads of silicone to approximately 2mm.

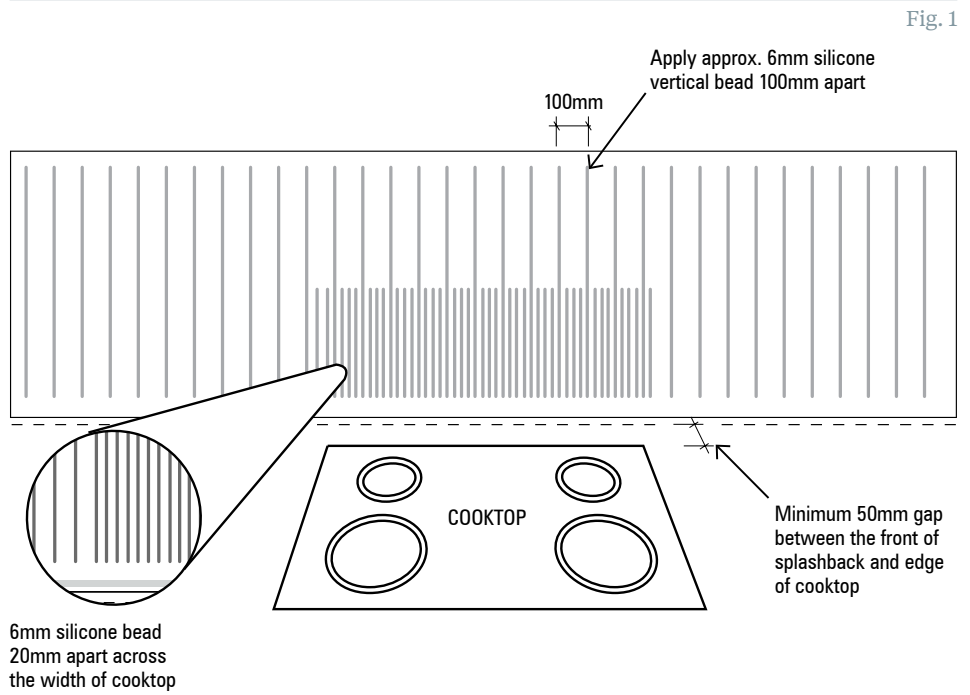
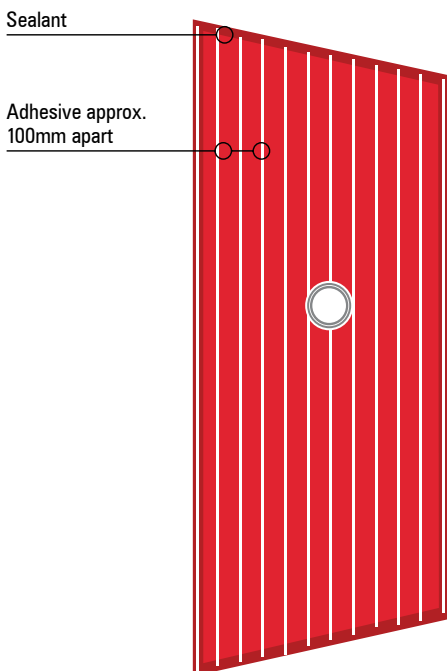

Fig. 1

Fig. 2



Adhering to the Wall

Figure 2
Each Bellessi sheet will expand and contract 4mm into and out of the corner silicone joint.

The first sheet will butt into the wall and allow for 4mm expansion while the second sheet will butt on to the first Bellessi sheet allowing for expansion and contraction against the first Bellessi sheet which was installed. This will reduce the visible join line to 4mm instead of 8mm.

When laying your Bellessi panel to your wall with the use of your straight edge (*figure 3*) ensure sufficient force is used to reduce the gap between the panel and your wall to a maximum 2mm. This will ensure correct adhesion of your panel to the wall with your neutral cure silicone. Failure to do so could result in insufficient adhesion of your Bellessi panel to your wall and void your warranty.

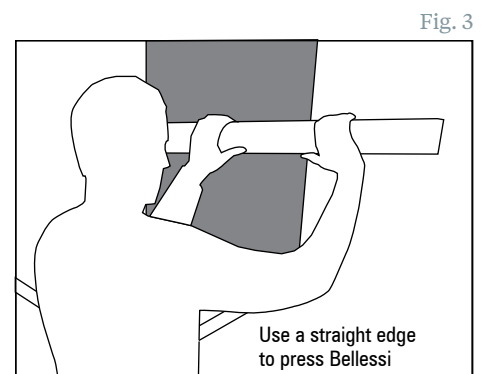

Fig. 3

Joining Sheets Together

Silicone Join

General Silicone System

Silicone jointing systems are acceptable for use in both wet and dry areas. In all instances standard glazing industry silicone jointing practices must be followed. Use only neutral cure silicone when joining Bellessi.*

* Bellessi warranty does not cover adhesion of your silicone or damage that can be caused by its use. Seek manufacturers advice where required.

Internal Corner

External Corner

Edge Cap

—*Supplied by aluminum supplier*

Butt Join

Internal Mitred Corner

External Standoff

Internal Standoff

External Mitred

External Butt

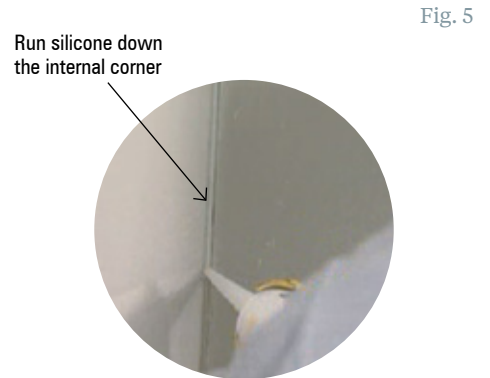
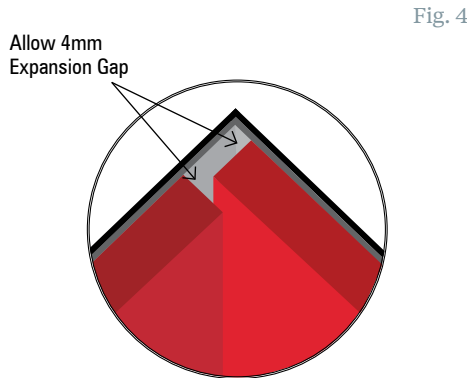

Sealing the Internal Corner

Bellessi suggest in accordance with water proofing standards a neutral cure silicone beed is run from the top of the Bellessi down the internal corner (figure 5) to the bottom of the shower base to seal the panel. This is to prevent any moisture penetrating down behind the lining.

Special attention should be paid to the top and bottom of the internal corner and anti-fracture membrane areas.

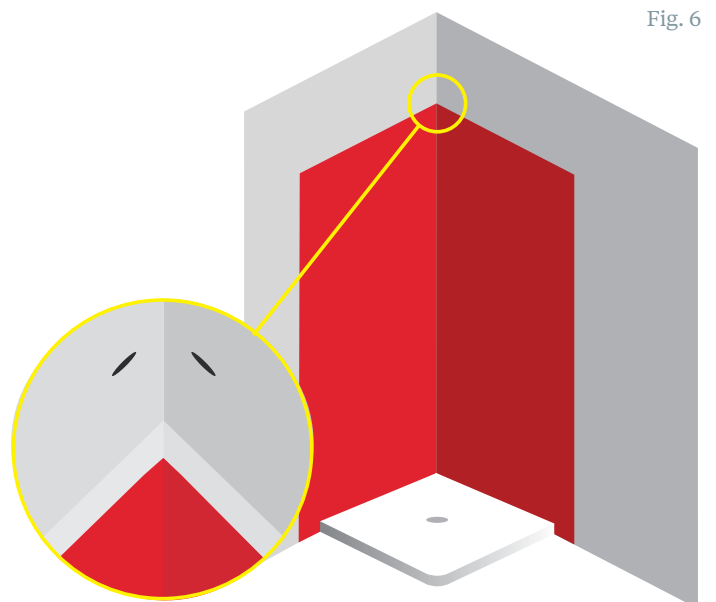

Note: The waterproofing system for your bathroom or shower must meet specific Australia standard building regulations.

What Adhesive do I Use?

—Continued

Taps and Shower Fittings

Peel back protective film from front face of Bellessi, to 25mm beyond the outer edge of the tap spindle installed perimeter.

Apply a bead of recommended neutral cure clear silicone around the perimeter and a second bead around the cut out in your Bellessi panel.

Both beads should be finished as per the example in figure 1 leaving a break at the bottom of the bead allowing for condensation or moisture drainage.

Fix tap spindle as per manufacturer’s instructions.

Fig. 1

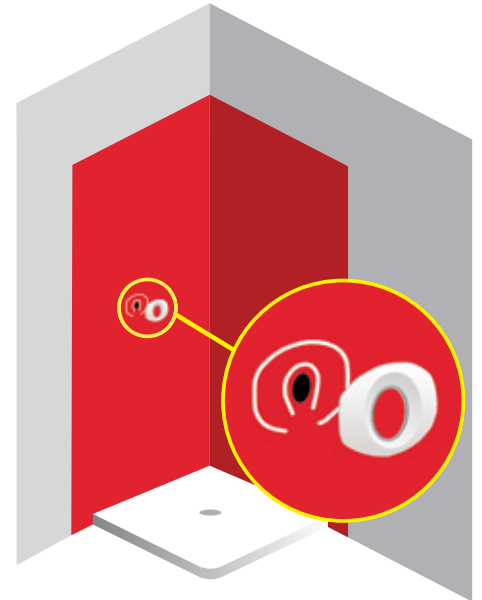

Butting More Than 2 Sheets Together

Measure and cut Bellessi Panel to size and geometry required. De-bur all edges.

Remove protective film from the rear of panel.

Apply adhesive to specification.

Install leading edge allowing 3mm expansion?

Press panel firmly with your straight edge ensuring to compress your silicone bead to the 2mm spacing between sheet and your wall allowing correct adhesion.

Ensure panel is a good fit onto the wall.

Clean up any adhesive that spills out onto the wall.

Fig. 2

4mm spacing between sheets

4mm spacing between sheets

Note.
Leave protective film on front of panel until installation is complete.



Bathroom Installation

Sealing Edges, Perimeters and Cut Outs

Figure 3

It is important to protect the rear (coated) side of Bellessi from moisture. Bellessi needs to be sealed with a band of neutral cure silicone extending 50mm from the edge of the panel.

This should include:	The perimeter of the sheet including any cut outs made
	Perimeter of any penetrations made I.e. tape holes
	The edges of these cut outs

Installing Bellessi into a Shower Tray

Figure 4

Acrylic shower trays are commonly installed using the system detailed below.

Acrylic tray should be mounted up to the bottom plate of wall in accordance with the manufacturer's installation instructions.

A manufactures recommended water proof board should be laid against framing following manufacturer's instructions, down to within 6mm of shower tray.

A neutral cure clear silicone should be installed between top of tray and bottom edge of wall lining in a continuous bead, then smoothed off as illustrated.

Fig. 3

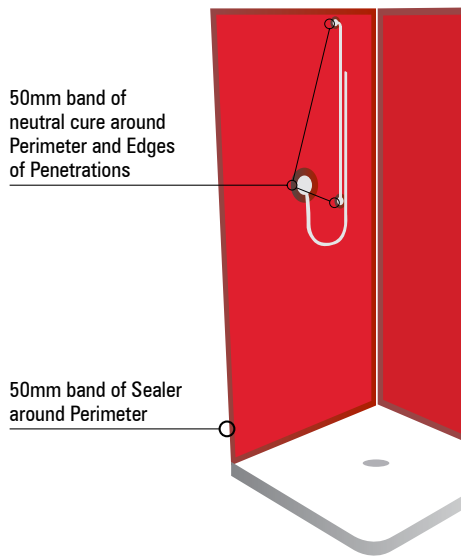
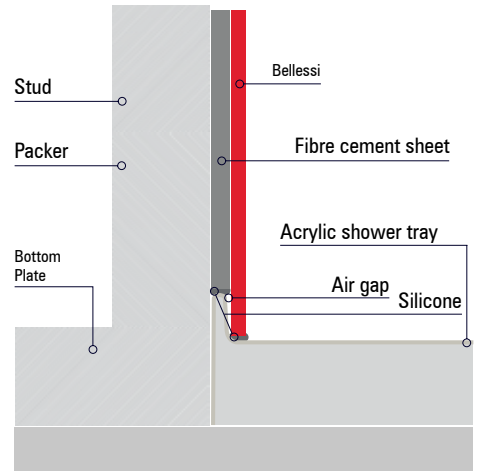

Fig. 4



Note: The waterproofing system for your bathroom or shower must meet specific Australian standard building regulations.

Fig. 5

Bellessi is then installed over the wall lining and over the up-stand lip of the tray, as illustrated above with a bead of flexible caulking between the back of Bellessi and front of tray up-stand lip, and the top of tray and bottom edge of Bellessi.

A gap should be left between the two caulking beads to act as a capillary break.

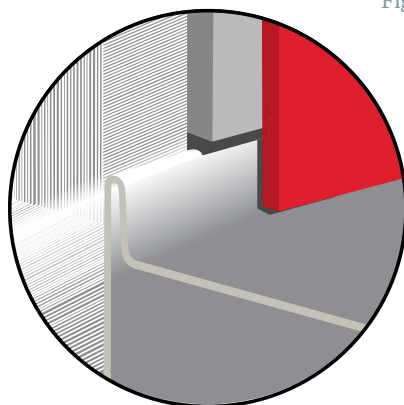
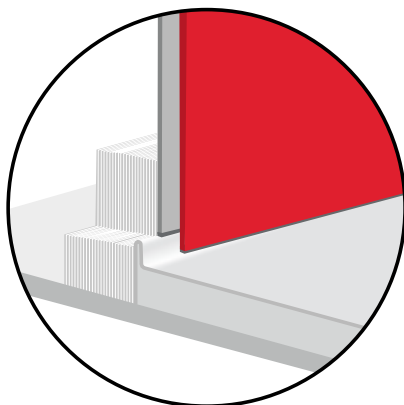

Pre-drilling Screw Holes

Shower frame

Do not screw directly into Bellessi as it may cause the Bellessi sheet to split. All holes must be pre drilled where fixing through Bellessi into a wall. You cannot fix anything directly into Bellessi panels.

Peel back protective film from front face of Bellessi, to the width of door return +25mm from the outer edge of Bellessi.

Fit door returns in place ensuring they are in the correct position and plumb.

Drill clearance holes through Bellessi and wall linings using a blunt drill bit outlined in detail for machining Bellessi.

A minimum of 3 fixing points should be used in a 1.8m high shower.

A minimum of 4 fixing points should be used in a 2m high shower.

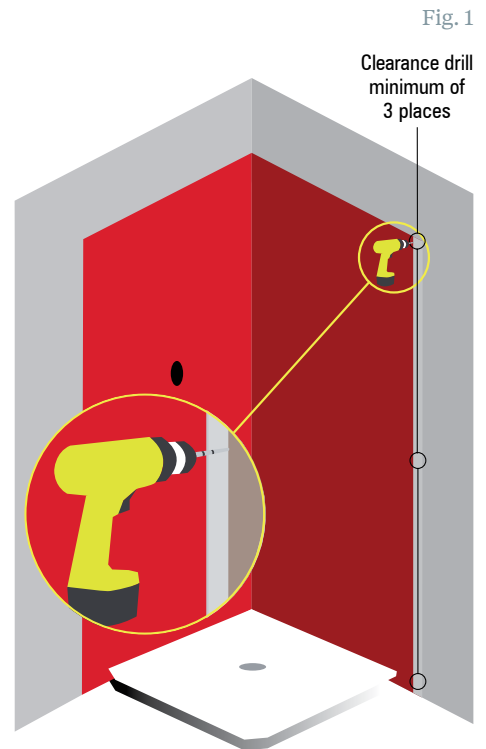

Installing the Internal Corner & Adhere Sheet

Remove the protective film from rear of Bellessi.

Seal the perimeter and all penetrations and penetration edges with a band of neutral cure silicon or acrylic sealant extending 50mm from the edge of the panel as illustrated,above.

Apply adhesive to rear of Bellessi as shown in the illustration,above.

Apply a bead of neutral cure clear silicone to the upstand lip of tray.

Apply a bead of neutral cure clear silicone along the full height of the corner onto the liner at the edge of the anti-fracture membrane

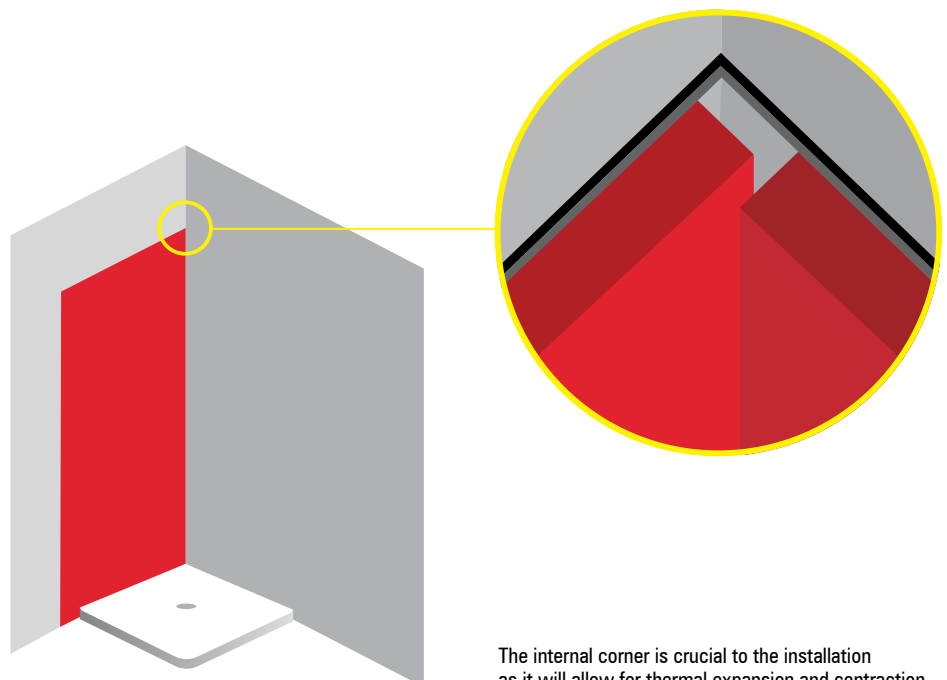

The internal corner is crucial to the installation as it will allow for thermal expansion and contraction.

Sealing the Internal Corner

Bellessi suggest in accordance with water proofing standards a neutral cure silicone bead is run from the top of the Bellessi down the internal corner to the bottom of the shower base to seal the panel. This is to prevent any moisture penetrating down behind the lining.

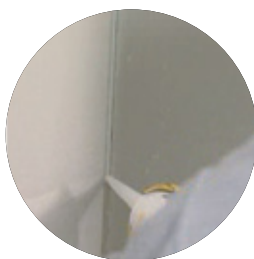

Note: Run Silicone down internal corner for water proofing.

Special attention should be paid to the top and bottom of the internal corner and anti-fracture membrane areas.

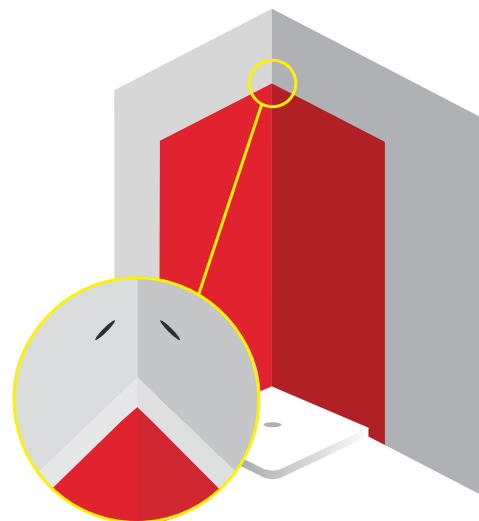

Note: The waterproofing system for your bathroom or shower must meet specific Australian standard building regulations.

Fitting the Showerscreen & Utilities

Fit the Shower screen to manufactures specification.

If the installer is required to fit any extra utilities or fittings to the Bellessi panel be sure to follow the steps listed in this document where machining or cutting is required.

This document is a guideline for installing Bellessi and will not wear any liability for waterproofing which should be installed to the current Australian Standard.

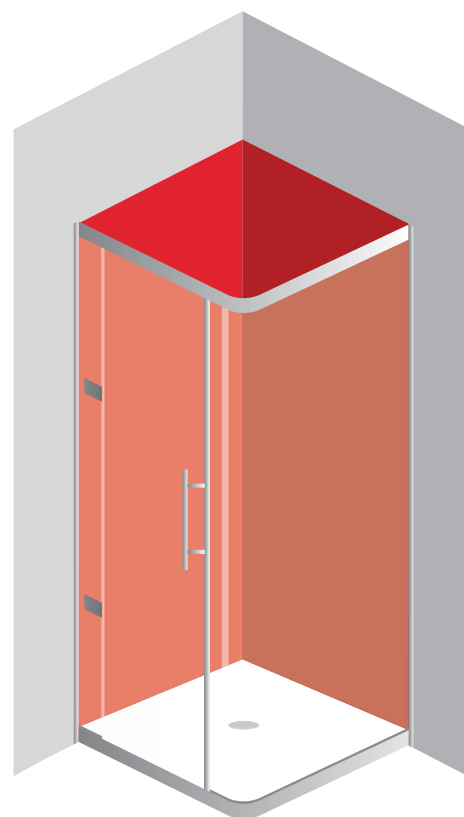

Shower Frames

Fit door returns back in place.

Fill holes with neutral cure clear silicone before screwing to the wall.

Check for plumb and position before final tightening of door return fastenings.

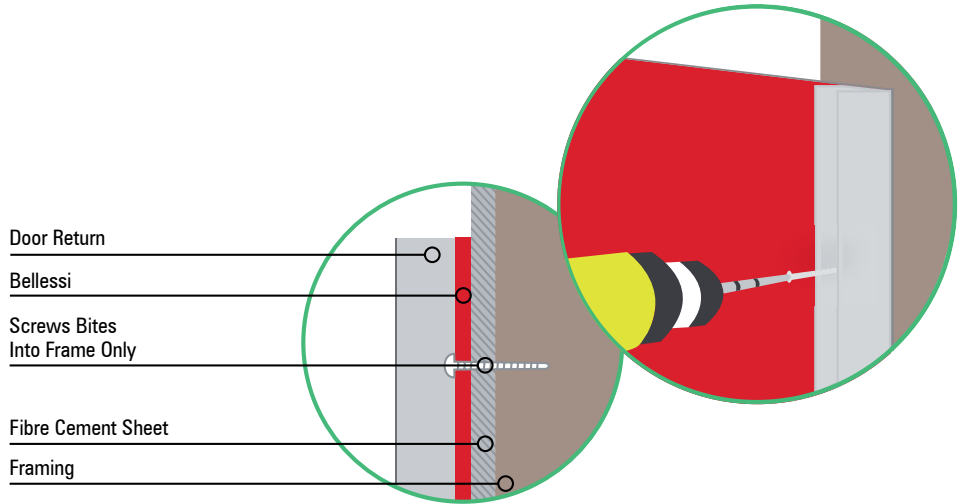

Installing Internal & External Corners

Remove backing paper.

Ensure there is an expansion gap of 3mm.

Apply silicone to the perimeter of the panel to seal the panel to silicone specification Page:

Press the face of the panel with a straight edge for surface adhesion with wall.

The internal and external corners are crucial to the installation as it will allow for thermal expansion and contraction.

Each Bellessi sheet will expand and contract 3mm into and out of the corner silicone join.

The first sheet will butt into the wall and allow for 3mm expansion while the second sheet will butt onto the first Bellessi sheet allowing for expansion and contraction against the first Bellessi sheet which was installed. This will reduce the visible join line to 3mm instead of 6mm.



3MM EXPANSION GAP

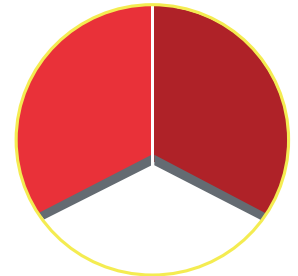
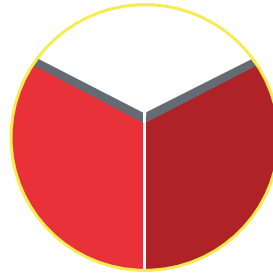

Removing Protective Film

Bellessi is supplied with protective film on both sides:

Recycled Sticker: Bellessi is also supplied with a recycled sticker number 7, which should be left on the Bellessi for its recycled life after use.

Painted Side: has a plastic film design for protection of the painted surface. Remove this film when all machining operations are complete and the panel is ready to be adhered to the wall/surface.

Exposed Side: has a clear plastic film designed for protection against scratches.

Remove the film completely at the very last stage by gently peeling down the sheet surface – never peel at right angles to the sheet as this may pull the sheet away from the installed wall/surface.

Never attempt to cut the protective films with a knife as this may scratch the surface.

Finishing the Edge After Cutting

If the Bellessi edge is to be left exposed, it can be easily finished to a polished glass-like quality. A good finish left from the machining process will take considerably less time to finish.

Always peel back the protective film 25mm from the edge while polishing. Remove any sanding dust between grades and polishing compounds immediately.

HAND FINISHING

1. Use an 800 grit wet and dry sandpaper to remove any cutter marks from the machined edge.
2. Chamfer any burrs or marks from the corners.
3. Using a soft, clean cloth and a suitable polishing compound, hand rub the edge to a polished finish.

FLAME POLISHING

A well-machined edge can be flame polished using a Hydrogen/Oxygen mix.

Contact an Acrylic fabricator for this service. An experienced operator can leave an excellent finish.

Repair & Maintenance

Note:
Only scratches on the front (non painted) side of your panel can be repaired. If you scratch the painted side (rear) of your panel a colour matched paint will need to be sourced to cover the scratch.

Finer scratches can simply be buffed out of your Bellessi splashback using an electric variable speed polisher with a lambs wool or 3000 grit foam pad and cutting compound.

We recommend the use of Juice car polish and cutting compounds. " Juice Q Cut" compound is the perfect general purpose cutting compound to remove ultra fine scratches and blemishes.

Deeper scratches will require more care and the use of wet and dry sandpapers in conjunction with an electric variable speed polisher to bring your panel back to its original luster.

Fine scratches

Apply your cutting compound directly to the area of your Bellessi panel that needs to be repaired. Then apply further compound directly to the polishing pad on your polisher. With your polisher set to a medium speed (1200–1800rpm) rotate the polishing pad in a circular motion until most of the compound is gone and your scratch is removed. Take care not to polish away compound totally as an unlubricated polishing pad will damage your panel. You may need to repeat this step to achieve the best result. Once complete remove any excess compound with a cleaner.

Deep scratches

For deeper scratches the use of wet and dry sandpaper may be required before polishing. When sanding out deeper scratches the use of a hard sanding block is required as this will prevent deep channels from being created by the use of a finger sanding. Use 1200 grit wet and dry sand paper and continuously lubricate the wet and dry sandpaper with water while sanding. Once you have removed the scratch then you are required to polish the area in the same way you polish fine scratches. This will ensure you have a gloss finish to match the rest of your panel.

At times you may need to re polish a larger area than normal that is damaged by your scratch to give an even finish. Often deep scratches may require the use of progressive grades of sand paper to achieve the best result. If you do not succeed in removing the scratch the first time then you will need to progressively attack the scratch using a course, medium to fine wet and dry sandpapers then polish. While this will require extra time you will be able to achieve a required result.

For further information on polishing and cutting compounds visit:
www.juicepolishes.com.au

Freecall Bellessi
1800 45 47 44

—
www.bellessi.com.au

bellessi

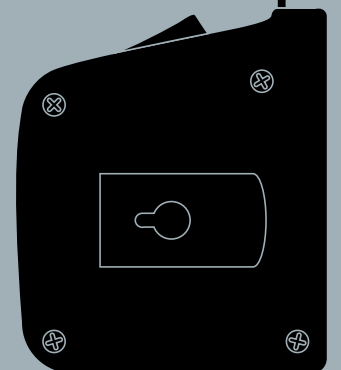

bellessi

