



**RACPWS22**  
**RACPWS23**



## IMPORTANT!

It is essential that you read the instructions in this manual before assembling, operating, and maintaining the product.

Subject to technical modification.

Safety, performance, and dependability have been given top priority in the design of your electric high pressure cleaner.

## INTENDED USE

The electric high pressure cleaner is intended only for outdoor use. For safety reasons, the product must be adequately controlled by a two-handed operation.

The product is designed for home or domestic use. It is intended to clean machines, vehicles, buildings, tools, facades, terraces, floors, and concrete walkways by removal of stubborn dirt using clean water with or without cleaning detergent.

The product should be used in well-illuminated conditions.

Do not use the product for any other purpose.

**⚠ WARNING!** The product is designed for use with a neutral cleaning agent supplied or recommended by the manufacturer. The use of other cleaning agents or chemicals may adversely affect the safety of the product.

## GENERAL SAFETY WARNINGS

**⚠ WARNING!** Read all safety warnings and all instructions. Failure to follow the warnings and instructions may result in electric shock, fire, and/or serious injury.

- The product is not intended for use by children or persons with reduced physical, sensory, or mental capabilities, or lack of experience and knowledge. Children should be adequately supervised to ensure they do not play with the product.
- Wear a complete personal protective equipment when operating the product, such as boots, safety gloves, safety helmets with visor, and hearing protection. Use high-impact visors only with liquid splash protection.

**⚠ WARNING!** Do not use the product when people are within range unless they wear protective clothing.

- To reduce the risk of injury, keep children and visitors away. All visitors should wear

safety glasses and be kept at a safe distance from the work area.

- Ensure that the safety devices are in good working condition. Make sure that all safety devices are operating properly before each use.
- Do not use the product if important parts such as safety devices, high-pressure hoses, or trigger gun are damaged.
- Exercise caution when opening the trigger. Hold the trigger handle firmly with two hands to avoid injury when the trigger handle kicks back.

**⚠ WARNING!** During use of high pressure cleaners, aerosols may be formed. Inhalation of aerosols can be hazardous to health. Depending on the application, shielded nozzles can be used for high pressure cleaning, which will reduce the emission of hydrous aerosols. However, not all applications allow the use of such a device. If shielded nozzles are not applicable for the protection against aerosols, a respiratory mask of class FFP 2 or equivalent may be needed, depending on the cleaning environment.

- Always stop the product when you leave it unattended.
- High pressure jets can be dangerous if misused. Do not direct the jet to people, live electrical equipment, or the product itself.
- To avoid a risk of explosion, do not spray flammable liquids.
- Do not direct the jet against yourself or others to clean clothes or footwear.
- Do not use the product to clean electronic devices, clothes, or footwear.
- High pressure hoses, fittings, and couplings are important for the safety of the product. Use only hoses, fittings, and couplings recommended by the manufacturer.
- Injuries may be caused, or aggravated, by prolonged use of a tool. When using any tool for prolonged periods, ensure to take regular breaks.

**⚠ CAUTION!** The product must not be used on the drinking water supply without a backflow preventer. Water flowing through a backflow preventer is considered non-drinkable. Always observe the regulations of your local water utility company when connecting the product to a water supply line.

## ELECTRICAL SAFETY WARNINGS

- The plug must match the outlet. Never modify the plug in any way. Unmodified plugs and matching outlets reduces the risk of electric shock.
- Do not use the product if the power cord or other important parts, such as safety devices, are damaged.
- Check the power cord and the extension cord for damage before each use. If the power cord or the extension cord is damaged, it must be replaced by the manufacturer, its service agent, or similarly qualified persons in order to avoid a hazard.
- Before every use, examine the supply cord for damage. If there are signs of damage, it must be replaced by a qualified person at an authorised service centre to avoid a hazard.
- Keep the power cord away from heat, oil, and sharp edges.
- Never touch the mains plug and the socket with wet hands.
- Inadequate extension cords can be dangerous. If an extension cord is used, it shall be suitable for outdoor use, and the connection has to be kept dry and off the ground. Use a cord wheel to keep the socket at least 60 mm above the ground.
- The electric supply connection shall be made by a qualified electrician. It is recommended that the electric supply to this product should include either a residual current device that will interrupt the supply if the leakage current to earth exceeds 30 mA for 30 ms or a device that will prove the earth circuit.

## ADDITIONAL SAFETY WARNINGS

- Some regions have regulations that restrict the use of the product in some operations. Check with your local authority for advice.
- Before each use, check the product for damage. A damaged high-pressure hose must be replaced immediately. Ensure that all connections, such as high-pressure hose and nozzle, are secure. Unwind the hose properly so that they may not get twisted or kinked.
- Do not allow children or untrained individuals to use the product.

- Before starting any cleaning operation, close doors and windows. Clear the area to be cleaned of debris, toys, outdoor furniture, or other objects that could create a hazard.
- Never pick up or carry the product while the motor is running.
- Do not use the product in temperatures below 0°C.
- Do not use acids, alkalines, solvents, flammable material, bleaches, or industrial grade solutions in the product. These products can cause physical injuries to the operator and irreversible damage to the product.
- Always operate the product on a level surface.

**⚠ WARNING!** High pressure jet can be dangerous if subject to misuse. The jet must not be directed to people, animals, electrical devices, or the product itself.

- Hold the trigger handle securely with both hands. Expect the trigger handle to move when the trigger is pulled due to reaction forces. Failure to do so could cause loss of control and injury to yourself and others.
- Make sure that the air in the hose and pump is released before you turn on the product. To remove the air in the hose and pump, connect the water supply to the pump using a garden hose, connect the trigger handle to the pump using the high-pressure hose, disengage the trigger handle lock, and press the trigger until there is a steady flow.
- Exercise caution to avoid slipping or falling.
- Keep firm footing and balance. Do not overreach. Overreaching can result in loss of balance.
- Use only accessories that are recommended by the manufacturer. The use of improper accessories may cause injury.
- Never leave the product running unattended. Turn off the product. Do not leave the product until it comes to a complete stop.
- Be familiar with the controls. Know how to turn off the product and bleed the pressure quickly.
- Stay alert, and exercise control. Watch what you are doing, and use common sense.
- Do not use the product while tired, ill, or under the influence of drugs, alcohol, or medication. A moment of inattention while

operating the product may result in serious personal injury.

- Do not use the product if the switch does not turn it on and off. Any product that cannot be controlled with a switch is dangerous and must be repaired.
- Keep a minimum distance of 30 cm when cleaning vehicles. The high pressure jet may damage or burst vehicle tires and/or tire valves.
- Use a garden hose with a maximum length of 15 m and compatible with 12 mm hose connector.
- Before each use, ensure that the accessory is securely attached to the trigger gun.

### OVERLOAD PROTECTION

The product has an overload protection device that is activated when overheating or when a current spike occurs, automatically shutting down the power within the product. To resume operation, disconnect the product from the power supply, wait for about 15 minutes, and reconnect the product to the power supply.

### TRANSPORTATION AND STORAGE

**⚠ CAUTION!** Mind the weight of the product when selecting the storage location and during transportation to prevent accidents or injuries.

- Stop the product, disconnect from the power supply, and allow the product to cool down. Disconnect the product from the water supply before storing or transporting. Never place the product in any position other than upright.
- Clean all foreign materials from the product. Storing the product in an area with temperature below 0°C will damage the product. Store it in a cool, dry, and well-ventilated place that is inaccessible to children. Keep the product away from corrosive agents such as garden chemicals and de-icing salts. Store the product indoors only.
- Remove water from all hoses and the pump, and empty the detergent tank before storing the product.
- For transportation in a vehicle, secure the product against movement or falling to prevent injury to persons or damage to the product.

- Store the product indoor only. Storing the product in an area with temperature below 0°C will damage the product.

### MAINTENANCE

- Use only original manufacturer's replacement parts, accessories, and attachments. Failure to do so can cause possible injury, can contribute to poor performance, and may void your warranty.
- Servicing requires extreme care and knowledge and should be performed only by a qualified service technician. Have the product serviced by an authorised service centre only.
- Turn off the product, disconnect from the power supply, and allow the product to cool down. Make sure that all moving parts have come to a complete stop:
  - before cleaning the product
  - before maintaining the product
  - before replacing spare parts
- You may make adjustments or repairs described in this manual. For other repairs, have the product serviced by an authorised service centre only.
- Regularly inspect and maintain the product for safe operation. RYOBI recommends inspecting the product every 6 months.
- Check all nuts, bolts, and screws at frequent intervals for proper tightness to ensure that the product is in safe working condition. Any part that is damaged should be properly repaired or replaced by an authorised service centre.

### SAFETY DEVICES

- On/off switch
  - The on/off switch prevents unintentional operation of the product.
- Trigger handle lock
  - The trigger handle lock locks the trigger and prevents unintentional opening of the high-pressure jet.
- Pressure switch
  - The overflow valve prevents the permissible working pressure from being exceeded. If the lever on the trigger gun is released, the pressure switch turns off the pump and the high-pressure jet stops. If the lever is pulled, the pump turns on again.

- Overload protection
  - A thermal sensor protects the product from overloading. The product will automatically shut the power down while overheating.

## SYMBOLS ON THE PRODUCT



Read and understand all instructions before operating the product. Follow all warnings and safety instructions.



Class II tool, double insulation



Wear eye and hearing protection.



Never point the gun to human, animals, the product, power supply, or any electric appliances



The product is not suitable for connection to the drinking water supply without backflow preventer.



Regulatory Compliance Mark (RCM). Product meets applicable regulatory requirements.



Guaranteed sound power level



Maximum pressure



Power



Turn the bottom portion of the nozzle all the way to the right to activate low pressure mode for foaming/detergent.



Waste electrical products should not be disposed of with household waste. Recycle where facilities exist. Check with your local authority or retailer for recycling advice.

## SYMBOLS IN THIS MANUAL



Parts or accessories sold separately



Note



Warning



Connect to the power outlet.



Disconnect from the power outlet.



RACPWS22

RACPWS23

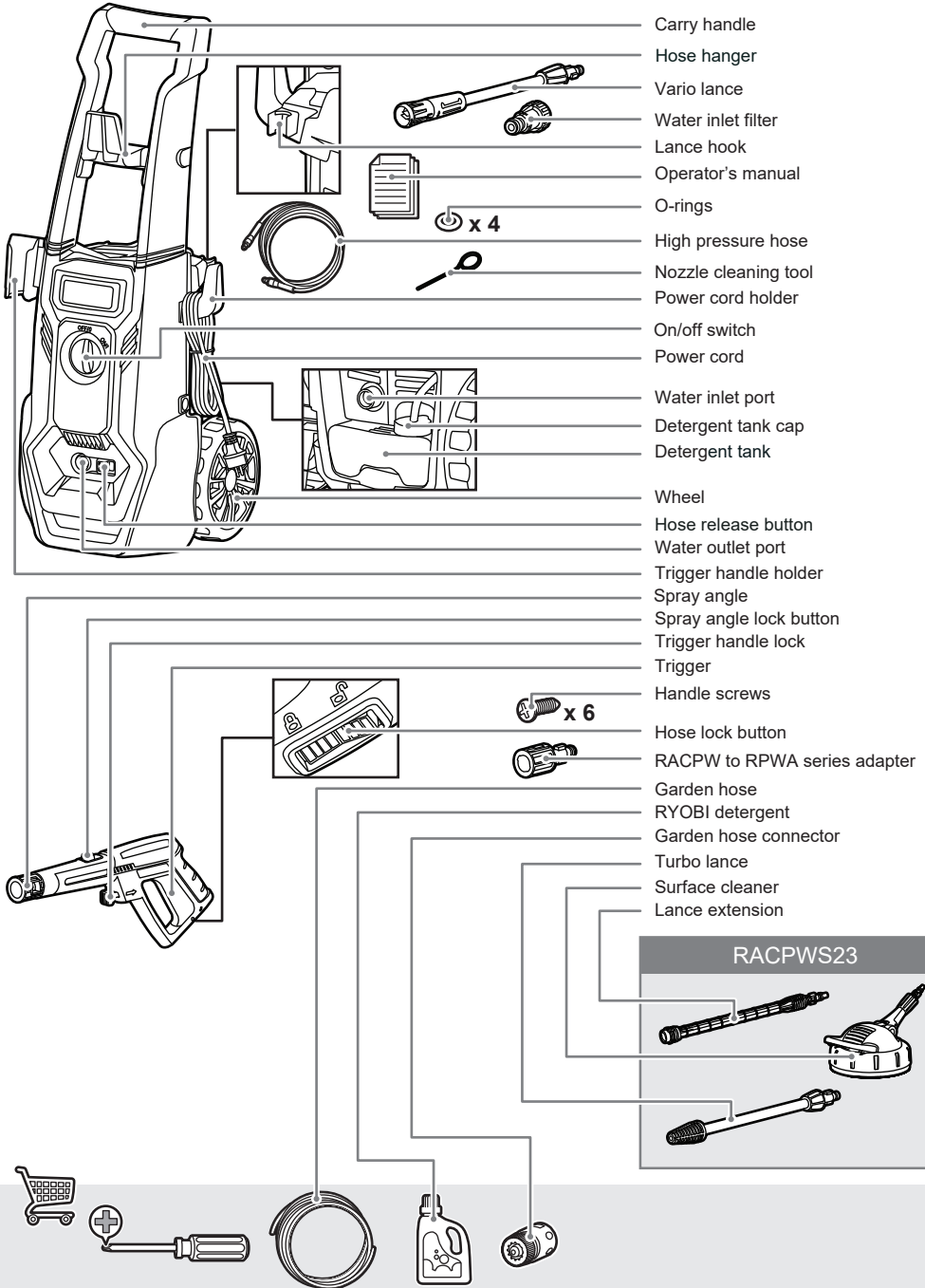



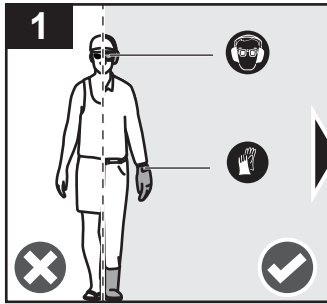

Wear full eye and ear protection, protective gloves, substantial footwear, and long trousers at all times while operating the product. Do not operate the product when barefoot or wearing open sandals.

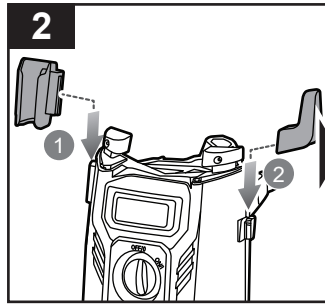

Push down the trigger handle holder until the buttons click, securing the handle in place. Push down the power cord holder until the buttons click, securing the handle in place.

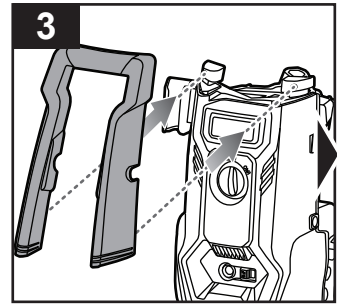

Attach the carry handle onto the product.

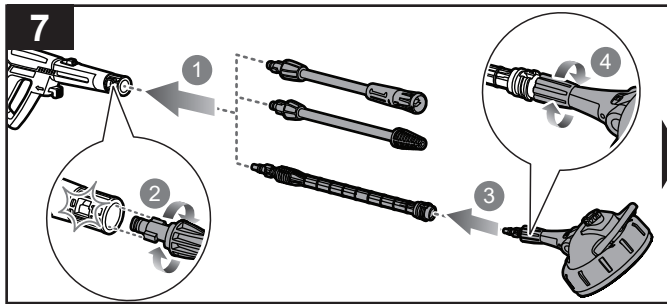

Install the preferred accessory. To install the vario lance or turbo lance into the spray angle, and turn the lance clockwise until it clicks into place. To install the surface cleaner, insert the end of the lance extension into the spray angle, and turn the lance until it clicks into place. Insert the surface cleaner into to the lance extension and turn the surface cleaner clockwise until it clicks into place.

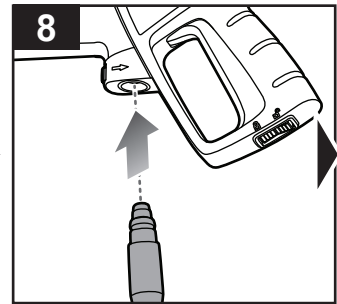

Insert the high pressure hose into the trigger handle.

**NOTE:** The hose lock button automatically slides out when the hose is inserted.

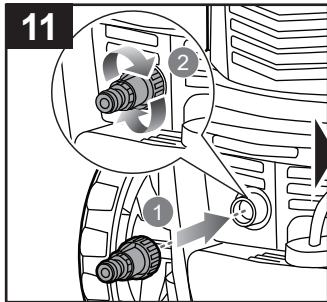

Connect and turn the water inlet filter clockwise to secure it to the water inlet port. Avoid cross-threading the filter and port to avoid water leaks.

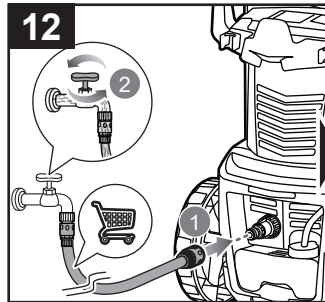

Connect one end of the garden hose to the inlet filter and the other end to the garden tap. Turn on the water source to allow water to flow into the product.

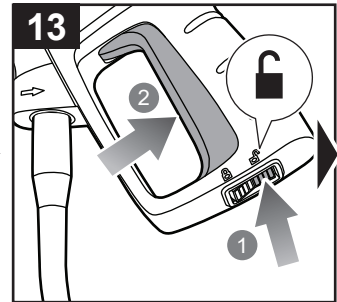

Set the trigger handle lock to the unlock position. Squeeze the trigger to release the existing air pressure within the product.



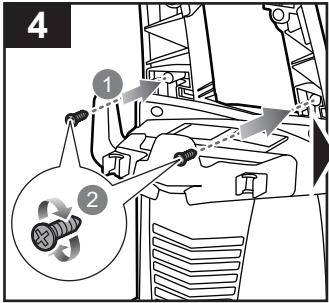

Secure the carry handle in place using handle screws. Turn the handle screws clockwise to tighten.

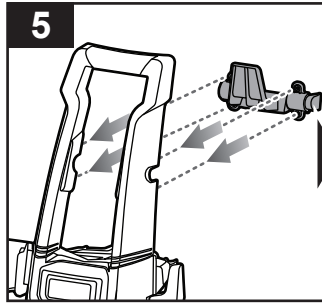

Attach the hose hanger onto the carry handle.

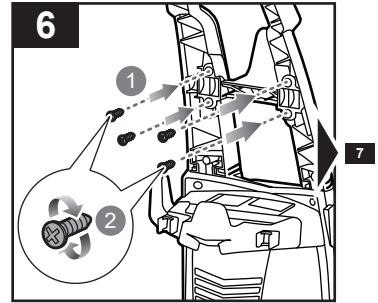

Secure the hose hanger using handle screws. Turn the handle screws clockwise to tighten.

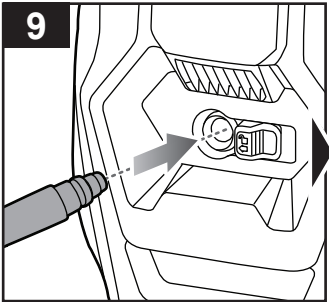

Insert the high pressure hose into the water outlet port.

**NOTE:** The hose release button automatically slides outward when the hose is inserted.

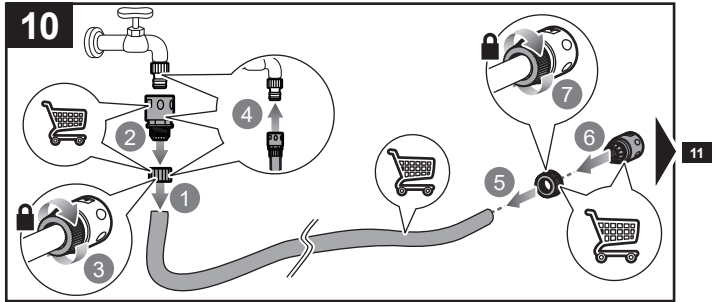

On one end of the garden hose insert a hose coupler. Insert a garden hose connector into the hose coupler and turn the connector clockwise to secure it. Connect the garden hose connector to the garden tap. On the other end of the garden hose, insert a hose coupler. Insert a garden hose connector into the hose coupler and turn the connector clockwise to secure it.

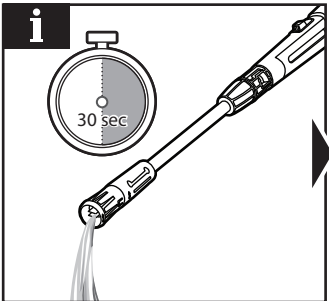

**NOTE:** Continue to squeeze the trigger until water flows normally. Always remove the existing air pressure within the product before operation.

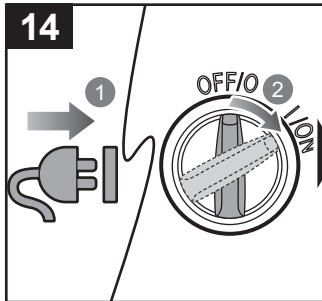

Connect the product to a power outlet. Turn the on/off switch to the on position.

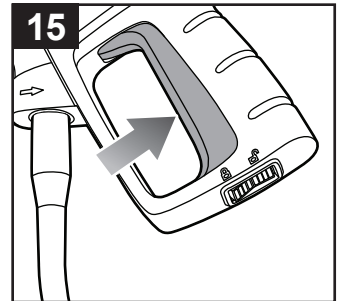

Squeeze the trigger to operate the product.

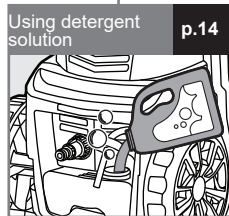
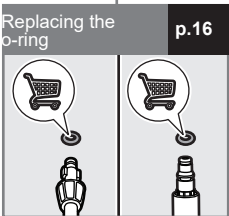
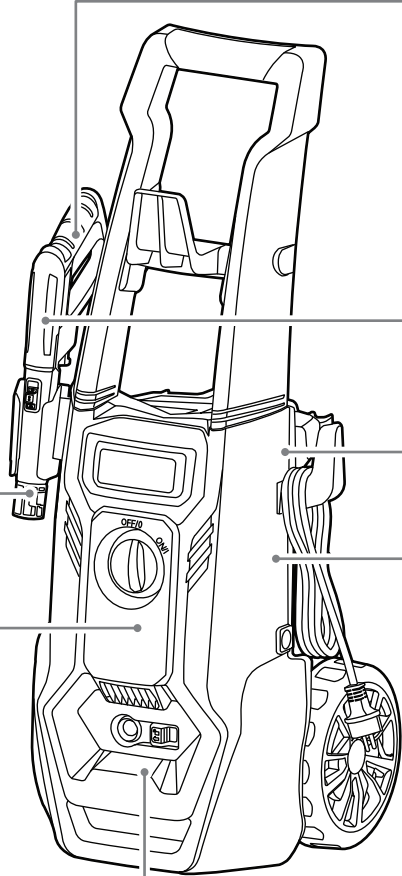
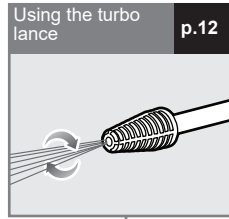
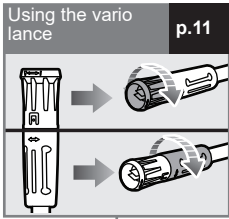

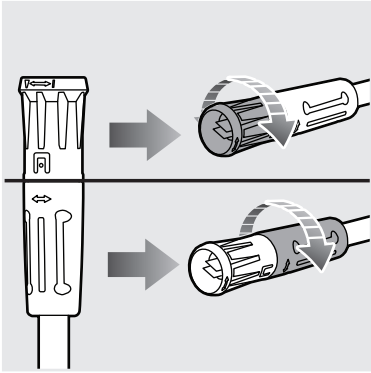

**USING THE VARIO LANCE**

**NOTE:** Turn the front end of the nozzle clockwise for a focused stream. Turn counterclockwise for a wider spray pattern.

**NOTE:** Turn the rear end of the nozzle counterclockwise or clockwise to increase or decrease water pressure. Use low water pressure for soaping applications.

**WARNING:** Check the work area before each use. Remove all objects, such as rocks, broken glass, nails, wire, or string, which can be thrown or become entangled in the product.

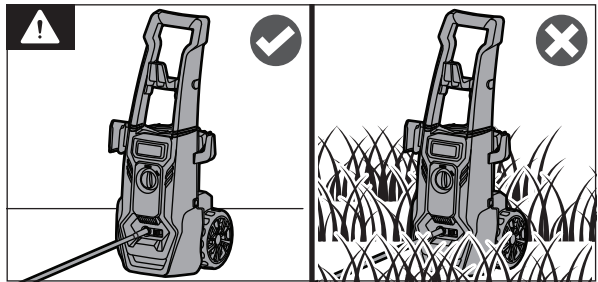
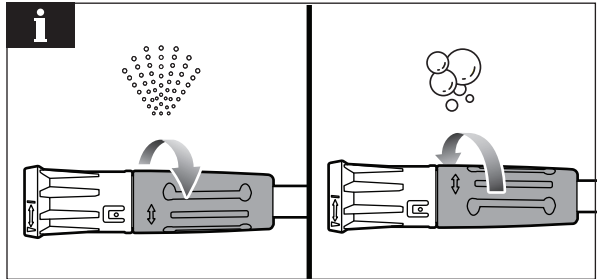
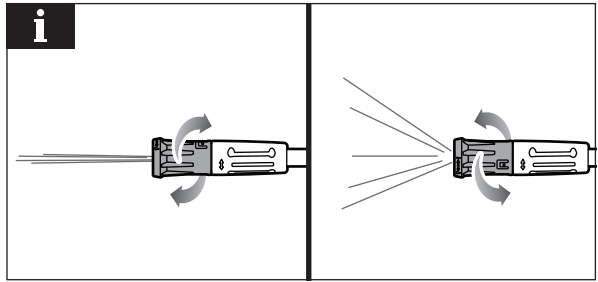

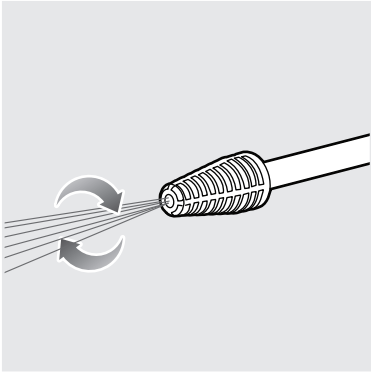

### USING THE TURBO LANCE

**WARNING:** Do not point the lance towards people, animals, live electrical equipment, or the product. The high pressure water immediately flows out after the product is turned on.

1. Turn the on/off switch to the off position. Set the trigger handle lock to the lock position.
2. Insert the the turbo lance into the spray angle. Turn the turbo lance until it clicks into place.

**NOTE:** Slide the spray angle lock button outward or inward to lock or unlock the turbo lance from the spray angle.

3. Turn the on/off switch to the on position. Set the trigger handle lock to the unlock position. Squeeze the trigger to operate the product.

**NOTE:** Water flows out when the trigger is squeezed.

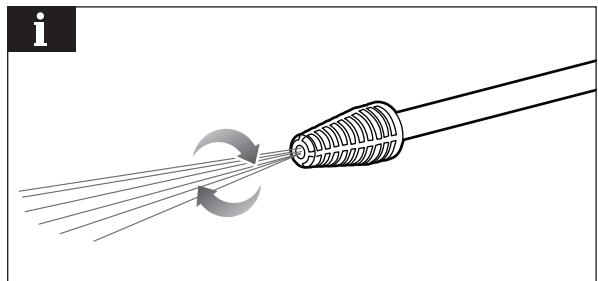
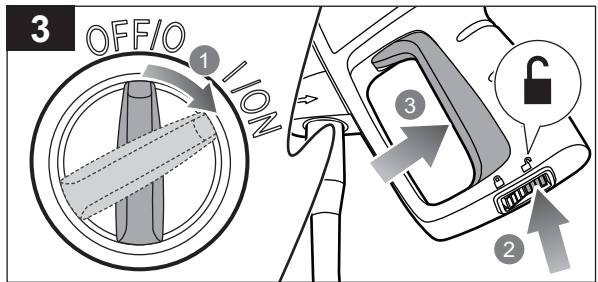
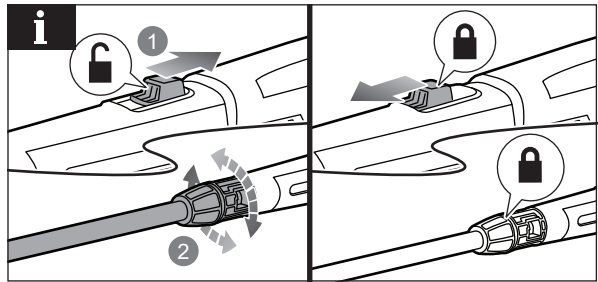
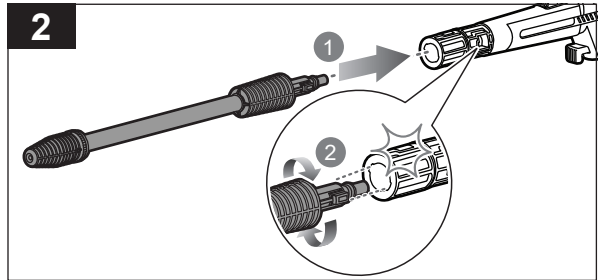
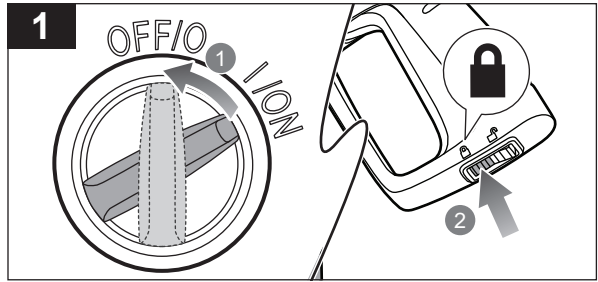



**USING THE SURFACE CLEANER**

1. Turn the on/off switch to the off position. Set the trigger handle lock to the lock position.
2. Insert the lance extension into the spray angle. Turn the extension until it clicks into place. Insert the surface cleaner into the extension. Turn the surface cleaner clockwise until it is secured.
3. Set the trigger handle lock to the unlock position. Squeeze the trigger to operate the product.

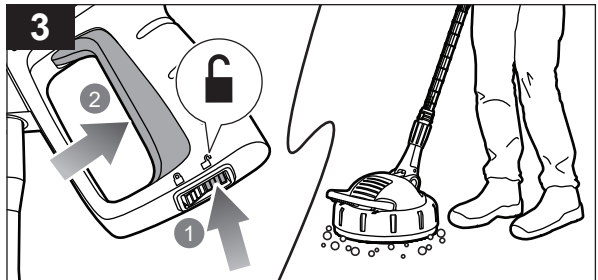
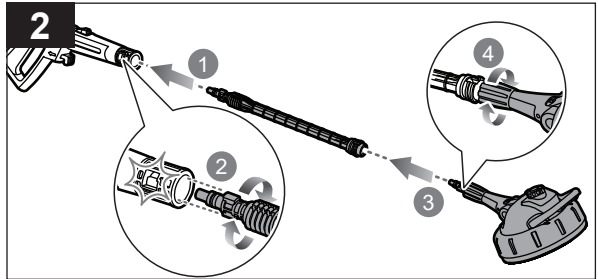
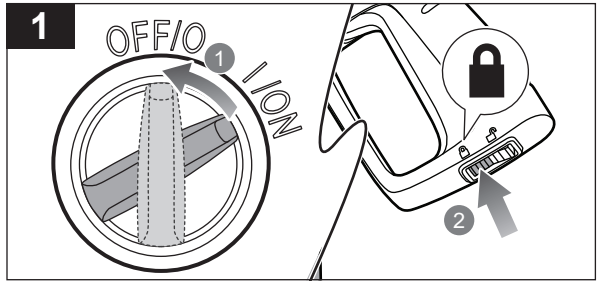

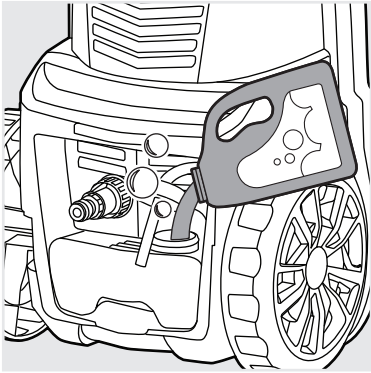

### USING DETERGENT SOLUTION

**WARNING:** Do not point the lance towards people, animals, live electrical equipment, or the product.

1. Turn the on/off switch to the off position. Remove the cap from the detergent tank.
2. Fill the tank with detergent solution.
3. Close the tank with the cap.
4. Insert the vario lance into the spray angle. Turn the lance clockwise until it clicks into place.
5. Turn the rear end of the nozzle counterclockwise to decrease the water pressure.

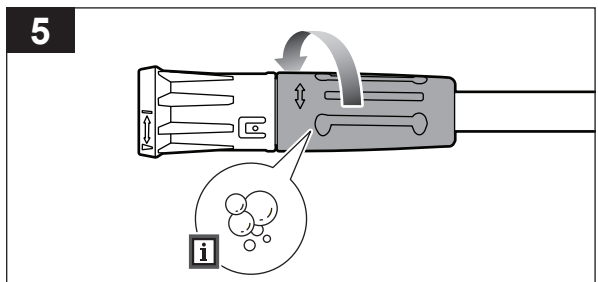
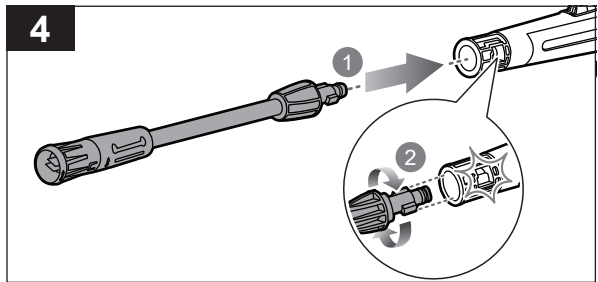
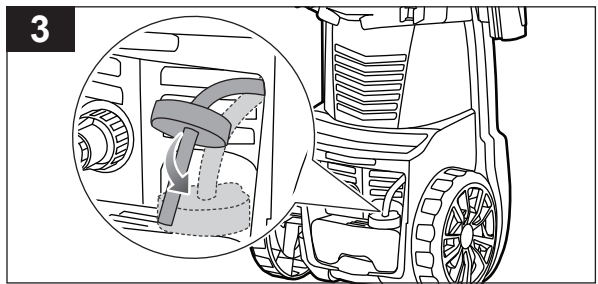
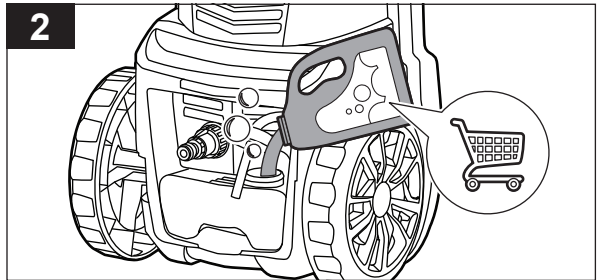
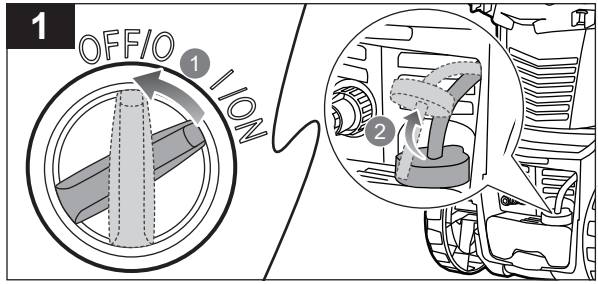

6. Turn the on/off switch to the on position. Set the trigger lock to the unlock position. Squeeze the trigger to operate the product.

**NOTE:** Turn the front end of the nozzle clockwise or counterclockwise to get a focused or spray water pattern.

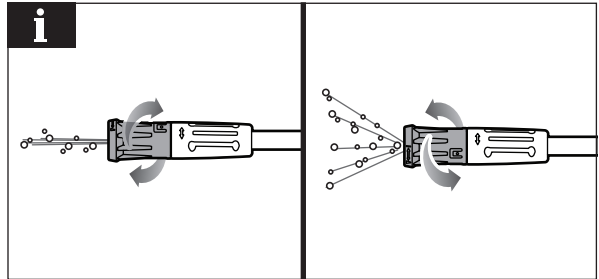
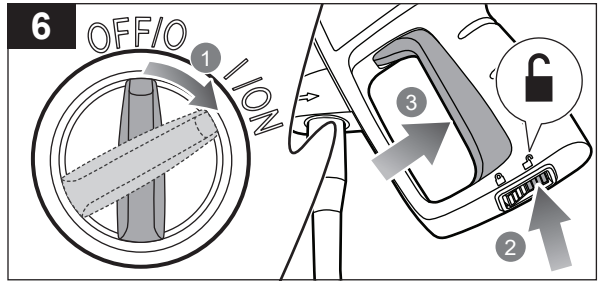



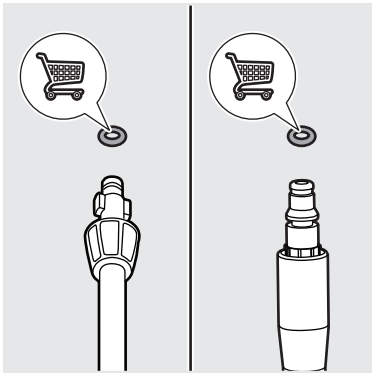

### REPLACING THE O-RING

1. Remove any damaged or cracked o-ring from the nozzle wand end or hose end.  
**NOTE:** Check the nozzle wand end or hose end for stretched, cracked, or split o-ring.
2. Dispose of the damaged o-ring properly. Contact your local distributor for the suitable replacement o-ring.
3. Insert the o-ring into the intended groove of the nozzle wand end or hose end.

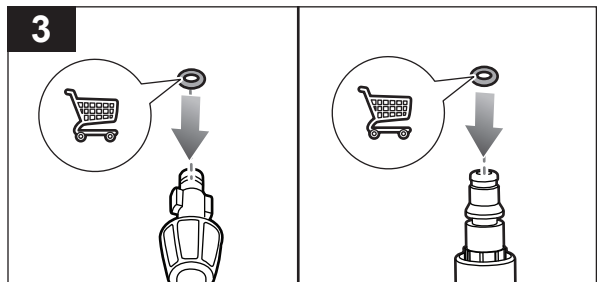
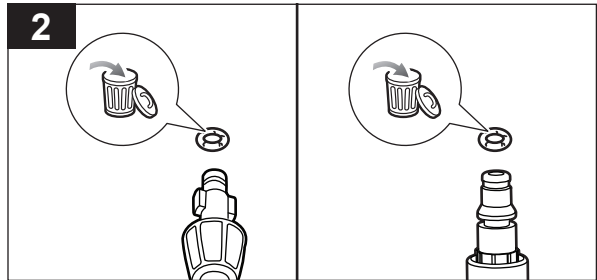
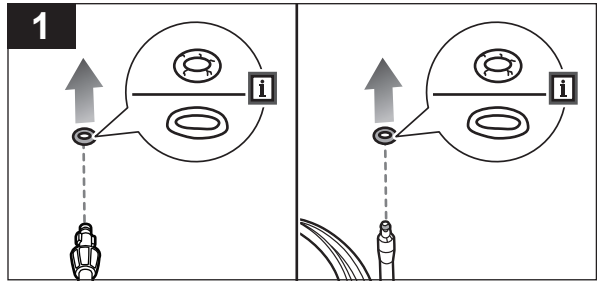

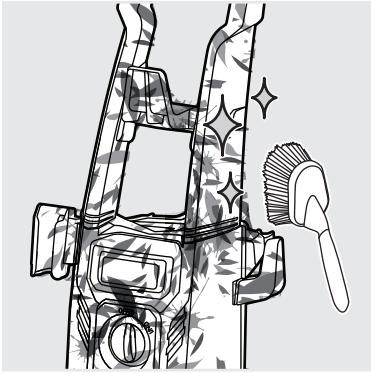

### CLEANING THE PRODUCT

1. Turn the on/off switch to the off position. Disconnect the product from the power outlet.
2. Clean the product using a brush.

**WARNING:** Avoid using solvents when cleaning plastic parts. Most plastics are susceptible to damage from various types of commercial solvents. Use clean cloths to remove dirt, dust, oil, grease, etc.

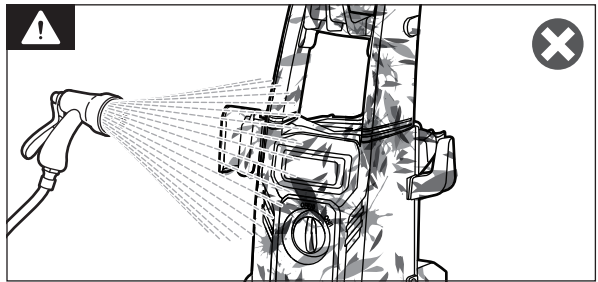
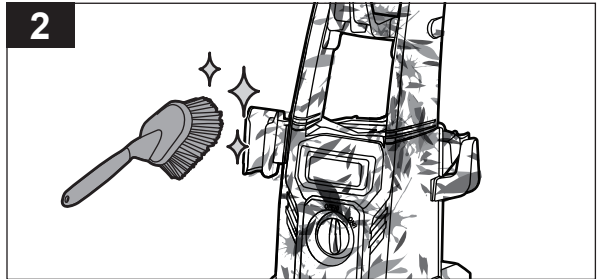
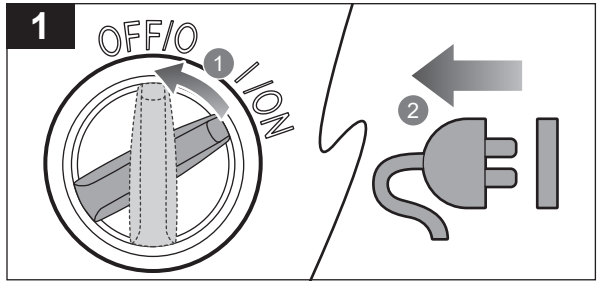



### STORING THE PRODUCT

1. Turn the on/off switch to the off position.
2. Disconnect the product from the power outlet.
3. Turn off the water supply.
4. Set the trigger handle lock to the unlock position. Squeeze the trigger until no more water flows out of the product.
5. Set the trigger handle lock to the lock position. Push the hose release button towards the outlet port, and disconnect the hose.

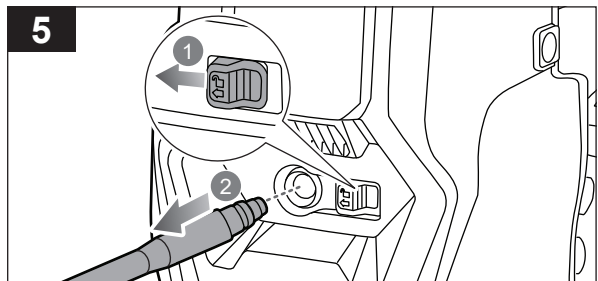
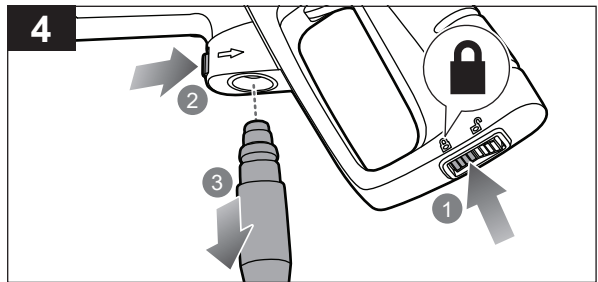
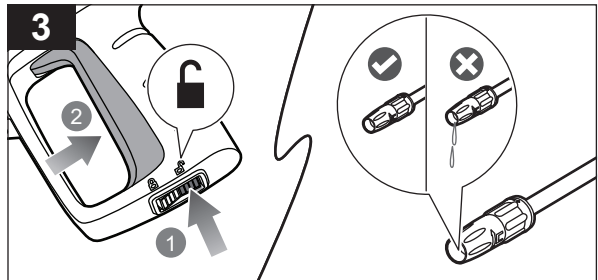
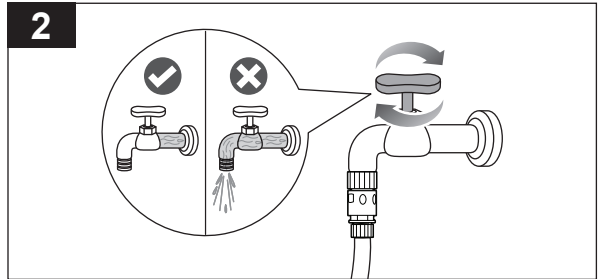
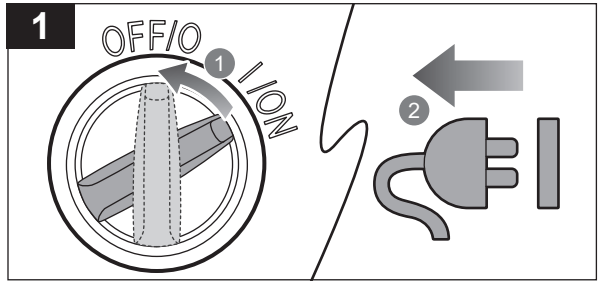

6. Disconnect the garden hose from the water inlet port and garden tap.

**NOTE:** If the product is pulsating intermittently or water is not exiting the nozzle smoothly, the nozzle may be blocked. Use the nozzle cleaning tool to remove blockages and clean the nozzle. Insert the cleaning tool into the nozzle and turn the tool to remove the blockages.

**NOTE:** Make sure to return the parts in their designated storage compartments.

8. Store the product in a cool, dry, and well-ventilated place that is inaccessible to children. Keep it away from corrosive agents, such as garden chemicals and de-icing salts. Do not store the product outdoors.

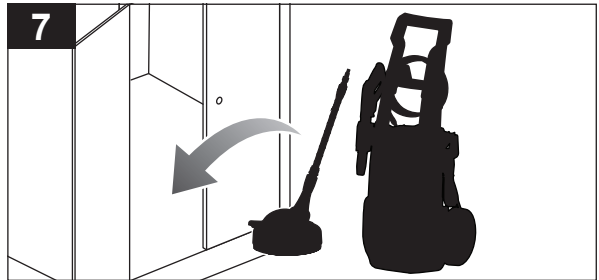
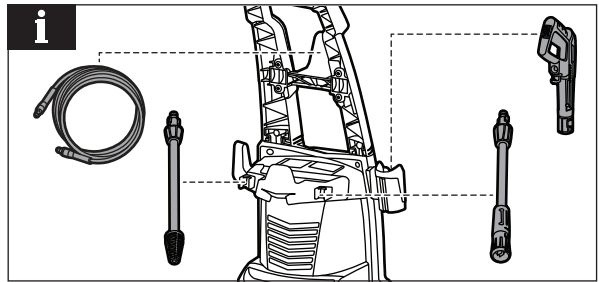
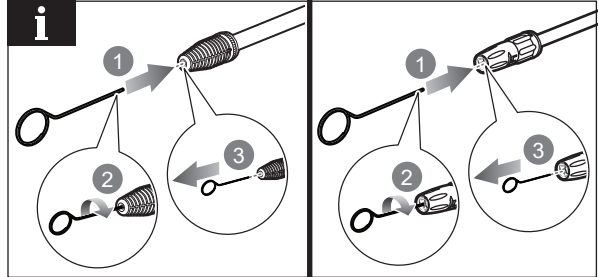
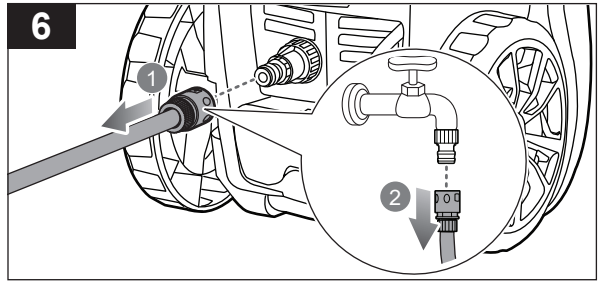

## PRODUCT SPECIFICATIONS

Electric high pressure cleaner

|  |                      |          |
|--|----------------------|----------|
| Model  | RACPWS22             | RACPWS23 |
| Rated voltage  | 220 - 240 V a.c.     |          |
| Frequency  | 50 Hz                |          |
| Power  | 1600 W               |          |
| Weight   | 7.97 kg              | 9.37 kg  |
| Maximum pressure   | 130 bar (1885 psi)   |          |
| Rated pressure   | 90 bar (1305 psi)    |          |
| Degree of protection   | IPX5                 |          |
| Rated flow   | 6 L/min              |          |
| Max. flow  | 7 L/min              |          |
| Max. inlet water pressure  | 12 bar (174 psi)     |          |
| Detergent tank   | 0.9 L                |          |
| Power cord length  | 5 m                  |          |
| Sound pressure level ( $L_{pA}$ ) (in accordance with EN 60335-2-79) | 73.5 dB(A)           |          |
| Uncertainty  | 3 dB                 |          |
| Sound power level ( $L_{WA}$ ) (in accordance with EN 60335-2-79)    | 87.5 dB(A)           |          |
| Uncertainty  | 3 dB                 |          |
| Vibration value (in accordance with EN 60335-2-79)                   | <2.5m/s <sup>2</sup> |          |
| Maximum garden hose length   | 15 m                 |          |
| Garden hose connection   | 18 mm (3/4 in.)      |          |

## ACCESSORIES

|      |  |
|------|--|
| RPW1 | Patio cleaner                              |
| RPW2 | Detergent bottle                           |
| RPW3 | Turbo lance                                |
| RPW4 | Fixed brush                                |
| RPW5 | Rotary brush                               |
| RPW6 | 8m hose replacement                        |
| RPW7 | RACPWS product to RPWA accessories adapter |

**⚠ WARNING!** The declared vibration total values and the declared noise emission values given in this instruction manual have been measured in accordance with a standardised test and may be used to compare one tool with another. They may be used for a preliminary assessment of exposure.

The declared vibration and noise emission values represent the main applications of the tool. However, if the tool is used for different applications, used with different accessories, or poorly maintained, the vibration and noise emission may differ. These conditions may significantly increase the exposure levels over the total working period. An estimation of the level of exposure to vibration and noise should take into account the times when the tool is turned off or when it is running idle. These conditions may significantly reduce the exposure level over the total working period.

Identify additional safety measures to protect the operator from the effects of vibration and noise, such as maintaining the tool and the accessories, keeping the hands warm (in case of vibration), and organising work patterns.











Imported by:  
**Techtronic Industries Australia Pty Ltd**  
31 Gilby Road, Mount Waverley, VIC 3149  
Melbourne, Australia

**Techtronic Industries N.Z. Limited**  
Unit C, 70 Business Parade South,  
Highbrook, Auckland 2013, New Zealand

*RYOBI is a trade mark of Ryobi Limited, and is used under license.*

