



18G C1 SERIES AIR BRAD NAIL GUN

- 18 GAUGE (C1 SERIES)
NAILS
- 100 NAIL CAPACITY
MAGAZINE
- 1/4 NITTO STYLE MALE
CONNECTOR



WARNING: Please Read the instructions and warnings for this tool carefully before use. Failure to do so could lead to serious injury.

INSTRUCTION MANUAL



WARNING: Read all safety warnings and all instructions. Failure to follow the warnings and instructions may result in electrical shock, fire and/or serious injury. Save all warnings and instructions for future reference.

SPECIFICATIONS - MODEL NO. FBABN-G18

Operating air pressure:	70 - 120psi (4.8 - 8.3bar)
Air consumption:	0.87L/cycle @100psi
Max pressure:	120psi (8.3bar)
Nail type:	18 Gauge C1 Series Brad
Nail length:	10 - 32mm
Magazine capacity:	100pcs
Air inlet:	1/4" Nitto style male connector
Weight (tool only):	1.2kg

Fasteners:

C1 Series 18G Brad NAILS

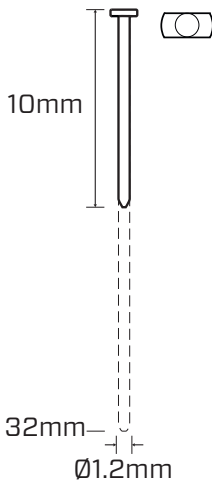

Collated

0° Angle

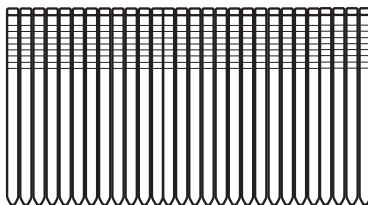

KNOW YOUR PRODUCT

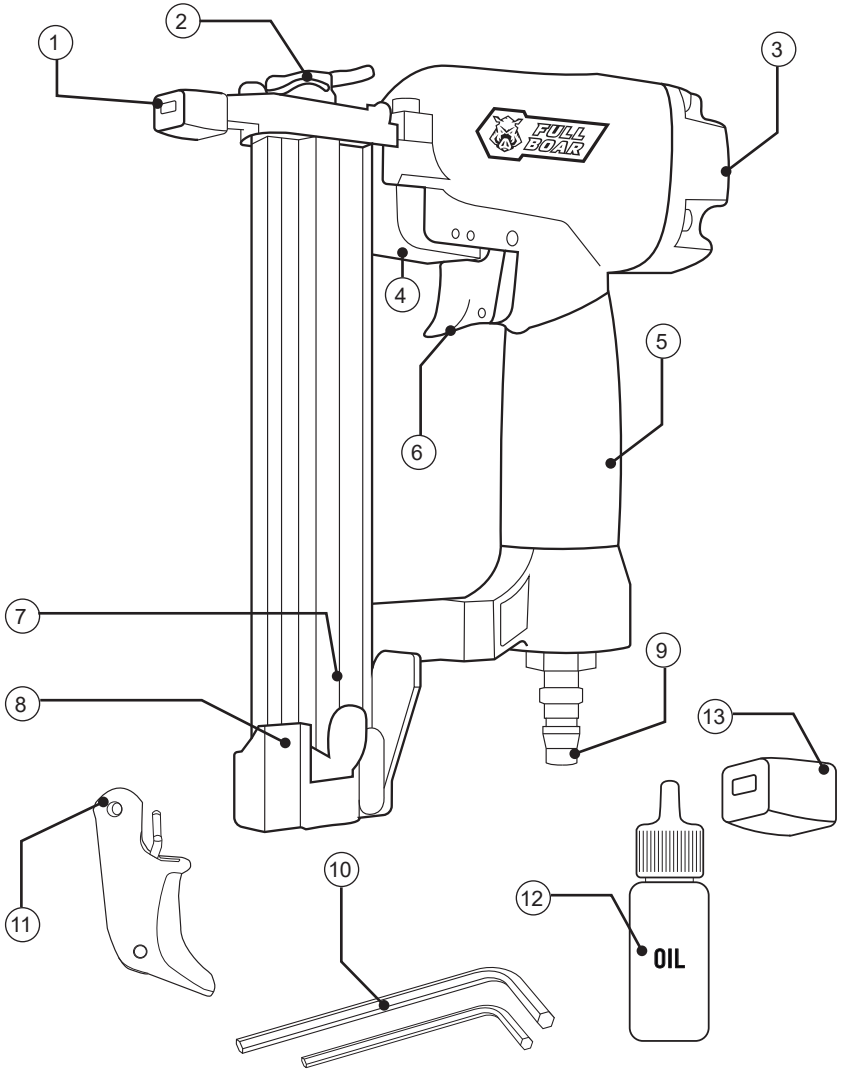

- 1. Drive Guide Cover
- 2. Cover latch
- 3. 360° Exhaust deflector
- 4. Depth adjustment selector
- 5. Handle
- 6. Trigger

- 7. Magazine
- 8. Moveable Magazine
- 9. Air Inlet quick connector
- 10. Hex keys x 2
- 11. Bump fire trigger
- 12. Oil bottle
- 13. Drive Guide Cover

TABLE OF CONTENTS

SPECIFICATIONS.....	Page 02
KNOW YOUR PRODUCT.....	Page 03
INTRODUCTION.....	Page 05
SAFETY INSTRUCTIONS.....	Page 06
SET UP AND PREPARATION.....	Page 12
OPERATION.....	Page 15
MAINTENANCE.....	Page 19
TROUBLE SHOOTING	Page 21
DESCRIPTION OF SYMBOLS.....	Page 22
CONTENTS.....	Page 23
WARRANTY.....	Page 24

INTRODUCTION

This Full Boar 18G C1 Series Air Brand Nail Gun is designed with power, reliability and durability for high volume applications. Offering three firing methods: Single, Sequential and Bump, this allows for greater operator control when working on decks, fencing and general woodworking. Features include a large magazine capacity of 100 nails and lengths from 10 to 32mm.

Read and understand the Owner's Manual before operating the Air Nail Gun. Failure to do so could result in personal injury or equipment damage.

LUBRICATION

An automatic in-line filter, a pressure regulator and automatic oiler is recommended as it increases the products service life. The in-line oiler should be checked regularly and filled with air tool oil.

It is most important that the product be properly lubricated by keeping the air line lubricator filled and correctly adjusted. Without proper lubrication the product will not work properly and parts will wear prematurely.

Use correct lubricant in the air line lubricator. The lubricator should be of low air flow or changing air flow type, and should be kept filled to the correct level. Use only recommended lubricants, specially made for pneumatic applications. Substitutes may harm the rubber compounds in the product's O-rings and other rubber parts.

GENERAL AIR TOOL SAFETY WARNINGS



WARNING! Read all safety warnings and all instructions. Failure to follow the warnings and instructions may result in electric shock, fire and/or serious injury.

Save all warnings and instructions for future reference. The term “power tool” in the warnings refers to your mains-operated (corded) power tool or battery-operated (cordless) power tool.

1. Work area safety

- a. **Keep work area clean and well lit.** Cluttered or dark areas invite accidents.
- b. **Do not operate power tools in explosive atmospheres, such as in the presence of flammable liquids, gases or dust.** Power tools create sparks which may ignite the dust or fumes.
- c. **Keep children and bystanders away while operating a power tool.** Distractions can cause you to lose control.
- d. **Dress properly. Do not wear loose clothing or jewellery. Keep your hair, clothing and gloves away from moving parts.** Loose clothes, jewellery or long hair can be caught in moving parts.
- e. **Check the maximum pressure rating of any tools or accessories that you intend using with the compressor.** The output pressure of the air from the compressor must be regulated so that it never exceeds the rated pressure of the tool or accessory.
- f. **Always wear high safety goggles or glasses when using the air tools.** Never point the nozzle of an accessory towards any part of your body or towards another person.
- g. **Drain the moisture from the tank daily.** It will help prevent corrosion.
- h. Use safety equipment including safety goggles and ear protection, the tool operator and all persons in the working area must wear safety goggles and ear protection.
- i. Air tools should not be used in a potentially explosive environment.
- j. **The tool must be used only for its prescribed purpose.** Any use other than those mentioned in this Manual will be considered a case of misuse. The user and not the manufacturer shall be liable for any damage or injury resulting from such cases of misuse.



WARNING! In the event that an air line is cut or broken, the air supply must be turned off at the compressor. A broken air line which is not supported is extremely dangerous and can whip around very quickly, both with the capability of striking people, and blowing foreign particles into the air.

Do not attempt to catch the air line but immediately keep bystanders well clear and turn off the air supply to the hose, turn off the compressor at the On / Off button, and then remove the hose from the compressor.

GENERAL AIR TOOL SAFETY WARNINGS (cont.)

- Please read and observe these operating instructions before using the tool. Basic safety measures should always be strictly followed to protect against damage to the equipment and personal injury to the user or other people working in the vicinity of operation.
- This appliance is not intended for use by persons (including children) with reduced physical, sensory or mental capabilities, or lack of experience and knowledge, unless they have been given the supervision or instruction concerning use of the appliance by a person responsible for their safety.
- **Children should be supervised to ensure that they do not play with the appliance.**

BRAD NAIL GUN SAFETY WARNINGS



WARNING! Disconnect the tool from the air supply before removing fasteners. Failure to do so could result in serious personal injury.

- **Read and understand instruction manual before using.**
- **Always wear impact-resistant eye protection during the operation of the air tool.**
- **Do not use this product if it is not completely assembled or if any parts appear to be missing or damaged.** Use of a product that is not properly and completely assembled could result in serious personal injury.
- **Always assume that the tool contains fasteners.** Careless handling of the tool can result in unexpected firing of fasteners and personal injury.
- **Do not point the tool towards yourself, anyone nearby or animals while operating.** Unexpected triggering will discharge the fastener causing an injury.
- **Do not actuate the tool unless the tool is placed firmly against the workpiece.** If the tool is not in contact with the workpiece, the fastener may be deflected away from your target.
- **Disconnect the tool from the air supply when the fastener jams in the tool.** While removing a jammed fastener, the tool may be accidentally activated if it is connected to the air supply.
- **Do not use this tool for fastening electrical cables.** It is not designed for electric cable installation and may damage the insulation of electric cables thereby causing electric shock or fire hazards.
- Do not carry tool with finger on the trigger.
- Keep the tool pointed in a safe direction at all times.
- **Never attempt to fire a fastener into material that is too hard,** or at a too steep of angle, or near the edge of the workpiece.
- **Disconnect the tool from the air supply before removing fasteners,** clearing a jam fastener, leaving work area, moving tool to another location, making any adjustments, performing maintenance, during non-operation or handing tool to another person. Failure to do so could result in serious personal injury.
- **Clean and inspect the tool daily.** Carefully check for proper operation of trigger and safety mechanism.
- **DO NOT use the tool unless both the trigger and safety mechanism are functional,** or if the tool is leaking air or needs any other repair.
- **Be aware that the failure of the work piece,** or accessories, or even of the fastener driving tool itself, can generate high-velocity projectiles.
- Air under pressure can cause severe injury.
- **Whipping hoses can cause severe injury.** Always check for damaged or loose hoses and fittings.

BRAD NAIL GUN SAFETY WARNINGS (cont.)

- DO NOT exceed the maximum pressure stated on the tool.
- Never carry an air tool by the hose.
- **Only use fasteners listed in the specifications may be used in the magazine.**
- Quick connector couplings shall be used for connection to the compressed air system and non-sealable air inlet connector must be fitted at the tool in such a way that no compressed air remains in the tool after disconnection.
- Fastener driving tools shall only be connected to an air supply where the maximum allowable pressure of the tool cannot be exceeded by more than 10%; in the case of higher pressure, a pressure reducing valve which includes a downstream safety valve shall be built into the compressed air supply.
- Check prior to each operation that the safety and triggering mechanism is functioning properly and that all nuts and bolts are right.
- Do not carry out any alterations to the air tool.
- **Avoid weakening or damaging the tool, for example by:**
 - punching or engraving;
 - modification not authorized by the manufacturer;
 - guiding against templates made of hard material such as steel;
 - dropping or pushing across the floor;
 - using the tool as a hammer;
 - applying excessive force of any kind.
- Hold the fastener driving tool during the work operation in such a way that no injuries can be caused to the head or to the body in the event of possible recoil consequent upon a disruption in the compressed air supply or hard areas within the workplace.
- **Never actuate the fastener driving tool into free space.** This will avoid any hazard caused by free flying fasteners and excessive strain of the tool.
- **Do not connect tool** to pressure that potentially exceeds 120psi (8.3bar).
- **Only use clean,** dry and regulated compressed air at 70 - 120psi (4.8 - 8.3bar)
- Keep all body parts such as hands and legs, etc. away from firing direction and ensure fastener cannot penetrate workpiece into parts of the body.
- When using the tool, be aware that the fastener could deflect and cause injury.
- Only technically skilled operators should use the fastener driving tool.
- This tool is not intended for driving into hard surfaces such as steel or concrete.
- Take care when handling fasteners, especially when loading and unloading, as the fasteners have sharp points which could cause injury.
- Do not overreach. Only use in a safe working place. Keep proper footing and balance at all times.

BRAD NAIL GUN SAFETY WARNINGS (cont.)

- Keep bystanders away (when working in an area where there is a likelihood of through traffic of people). Clearly mark off your operating area.
- During operation be careful that fasteners penetrate material correctly and cannot be deflected/misfired towards operator and/or any bystanders.
- Only wear gloves that provide adequate feel and safe control of triggers and any adjusting devices.
- The tool must be disconnected from the air supply and rested on a flat surface on its side when not in use.
- During operation, debris from workpiece and fastening/collation system may be discharged.
- Always wear impact-resistant eye protection with side shields during operation of the tool.
- Appropriate hearing protection shall be worn.
- The risks to others shall be assessed by the operator.
- Ensure tool is always safely engaged on the workpiece and cannot slip.
- Ensure the tool is correctly lubricated during use. Only use the correct lubricant as specified in this manual.
- Slips, trips and falls are major causes of workplace injury. Be aware of slippery surfaces caused by use of the tool and also of trip hazards caused by the airline hose.
- Proceed with additional care in unfamiliar surroundings. Hidden hazards may exist, such as electricity or other utility lines.
- This tool is not intended for use in potentially explosive atmospheres and is not insulated from coming into contact with electric power.
- Never use oxygen or combustible gases for operating pneumatic tools as this could create a fire and explosion hazard.
- Do not discard the manual and safety instructions.

BRAD NAIL GUN SAFETY WARNINGS (cont.)



WARNING! Do not rest your finger on the trigger when picking up the tool, moving between operating areas and positions or walking, as resting finger on trigger can lead to inadvertent operation. Always check the tool before use to ascertain the correct mode is selected.

This tool has contact actuation. (Bump Fire) Its intended uses are for production applications such as pallets, furniture, manufactured housing, upholstery and sheathing.

Do not use this tool in contact actuation for applications such as closing boxes or crates and fitting transportation safety systems on trailers and lorries.

Be careful when changing from one driving location to another.

SET UP & PREPARATION



WARNING! Ensure the tool is in the off position before connecting to the air supply.



WARNING! The tool's driving mechanism may cycle when the tool is first connected to the air supply. Always connect the tool to pressurized air supply before loading fasteners to prevent injury from unintended cycling. Always make sure the tool's magazine is empty at the beginning of each work session, before connecting to an air supply.

Connecting air supply

Under normal use conditions, the tool should be lubricated with air tool oil before connecting the tool to an air supply. Add air tool lubricate into the air tool once daily with minimal use, or twice a day with heavy use. Only a few drops of oil at a time is necessary. Too much oil will only collect inside the tool and will be noticeable in the exhaust cycle.

Before connecting the tool, check the air compressor gauge to be sure it is functioning within the proper range 70 - 120psi (4.8 - 8.3bar).

Note: The tool and air hose must have a quick-connect hose coupling that allows all pressure to be removed from the tool when the coupling is disconnected.

1. Pull back the sleeve on female quick connector hose coupling, insert male end and release sleeve on quick connector (fig. 1).

Note: For best performance use 3/8" I/D supply air hose.

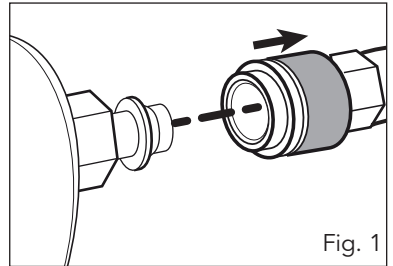

Fig. 1



WARNING! Ensure that the compressed air does not exceed 120psi (8.3bar) while operating the tool. Too high an air pressure and unclean air will shorten the product's life due to excessive wear, and may be dangerous causing damage and/or personal injury.



WARNING! Always use a coupling that discharges all the compressed air in the tool at the time the fitting or hose coupling is disconnected. Using a coupling that does not discharge the compressed air could cause unintended operation and serious personal injury..



WARNING! Do not climb rigging or scaffolding while carrying a tool that is connected to an air hose. Doing so could result in serious personal injury.

SET UP & PREPARATION (cont.)

360° Exhaust deflector

The adjustable exhaust deflector on the top of the tool allows the operator to direct the exhaust according to operator preference.

1. To adjust, rotate the exhaust deflector in the desired direction for the current application (fig. 2).

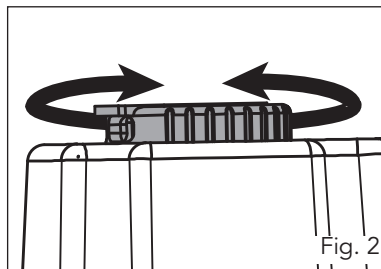

WARNING! Do not attempt to modify this tool or create accessories not recommended for use with this tool. Any such in a hazardous condition leading to possible serious personal injury.

SET UP & PREPARATION (cont.)

Loading fasteners



WARNING! Always connect the tool to pressured air supply before loading fasteners. Only use fasteners specified in the Specifications in this manual can be used. Keep the tool pointed away from yourself and others at all times. Do not load fasteners with the trigger (2) depressed.

1. Grip the handle firmly with one hand and with the other hand press down on the cover latch to release the magazine cover (fig. 3).

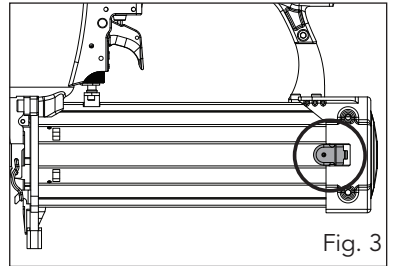

Fig. 3

2. Slide the magazine cover all the way to the rear of the magazine (fig. 4).

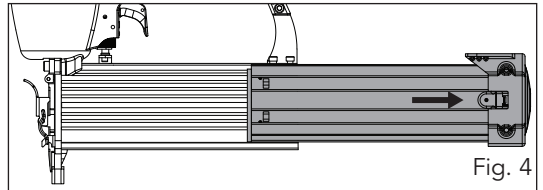

Fig. 4

3. Place the strip of fasteners into the magazine, be sure the fasteners are pointed downwards and sit in the bottom of the magazine. Now push the magazine cover forward and allow it to push the fasteners up to the driving mechanism (fig. 5). Push the magazine cover forward until it is locked. The tool is ready for use.

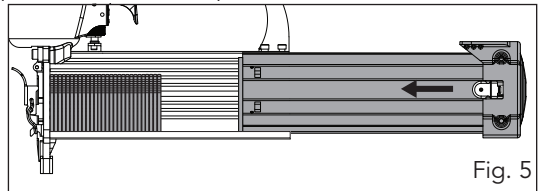

Fig. 5



WARNING! Do not carry tool with your finger on the trigger. Do not fire the tool without fasteners in the magazine.

OPERATION

Driving fasteners



WARNING! Do not operate the tool without fasteners in the magazine. Remove finger from trigger when not firing fasteners.

This tool has three firing methods: **Single fire**, **Sequential fire** and **Bump fire**. This allows for driving fasteners in different ways for precise accuracy or speed. The tool will be fitted with a single sequential fire trigger from the box. If the user wants to use bump fire, they must change the trigger. Refer to "**Fitting the bump fire trigger**" on page 19 of this manual.



WARNING! Always wear eye protection. Make sure the eye protection chosen has side shields or provides protection from flying debris both from the front and sides.

• Single fire - fires one fastener only (fig. 6-7)

This method will fire one fastener only when the tool is pushed against the work surface and each time the trigger is pressed, this is an accurate and more precise method of firing fasteners.

1. Grip the handle firmly.
2. Press the safety striker on the material until it is compressed completely and press the trigger to fire one fastener.
3. To fire again; first remove the safety striker from the material.

Note: Always remove your finger from the trigger after the fastener is driven into the workpiece.

4. Repeat the procedure for the next fastener.

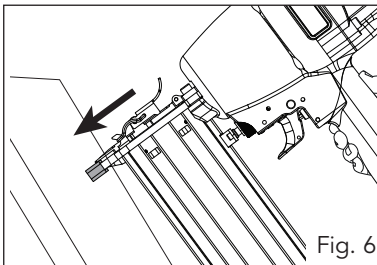

Fig. 6

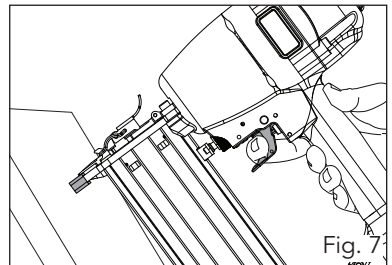

Fig. 7

OPERATION (cont.)

- **Sequential fire - fires one fastener after the other when the trigger is pressed.**

This method will fire a fastener when the trigger is pressed as you drag the safety striker along the work piece. This method is a much faster firing method.

1. Grip the handle firmly.
2. Press the safety striker on the material until it is compressed completely and press the trigger to fire one fastener.
3. To fire again; keep the safety striker pressed to the material and drag along the material whilst pressing and releasing the trigger to fire.

Note: Always remove your finger from the trigger after the fastener is driven into the work piece.

- **Bump fire - with Bump trigger equipped fires one fastener only each time the safety striker hits the material.**

This method will fire a fastener with the trigger pressed as you bump the tool along the workpiece making contact at the points where you want to insert the fastener. This method is less accurate but is a much faster firing method.

1. Grip the handle firmly.
2. Press the trigger and then bump the safety striker on the material to fire a fastener; each time the safety striker hits the material with the trigger pressed a single fastener will fire (fig. 8).

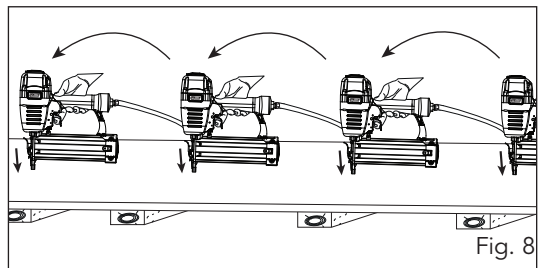

WARNING! Do not clamp or hold the trigger (2) with anything other than your hand.



WARNING! Do not over reach. Keep proper footing and balance at all times.

OPERATION (cont.)

Drive depth adjustment



WARNING! Keep the tool pointed in a safe direction. Disconnect the tool from the air supply and remove all fasteners. Failure to do so could result in serious personal injury.

The driving depth of the fastener may be adjusted. The depth of drive is made by rotating the Depth adjustment selector (fig. 9).

- If the fastener is driven into the work piece at an excessive depth (the fastener head is driven below the work surface), the depth adjustment selector should be rotated clockwise.

- If the fastener is protruding (the head is not flush with the surface), the depth adjustment selector should be rotated anti-clockwise.

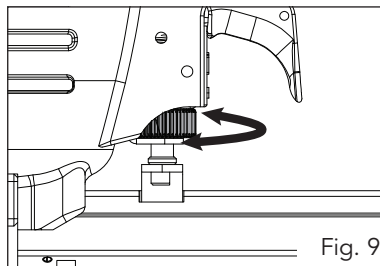

Removing fasteners from the magazine

1. Pull back the sleeve on female quick connector to disconnect the tool from the air supply.



WARNING! Disconnect the tool from the air supply before removing fasteners. Failure to do so could result in serious personal injury.

2. Grip the handle firmly with one hand and with the other hand press down on the cover latch to release the magazine cover.
3. Slide the magazine cover all the way to the rear of the magazine.
4. Tilt the tool up and remove the strip of fasteners from the magazine.
5. Push the magazine cover forward until it is locked.

OPERATION (cont.)

Clearing a jammed fastener



WARNING! Disconnect the tool from the air supply before clearing a jammed fastener. Failure to do so could result in serious personal injury.

If a fastener becomes jammed in the tool, disconnect the air hose and keep the tool pointed away from you while clearing the jam.

1. Pull back the sleeve on female quick connector to disconnect the tool from the air supply.
2. Remove fasteners from the tool.
3. Pull the front guide latch, releasing the front guide (fig. 10).

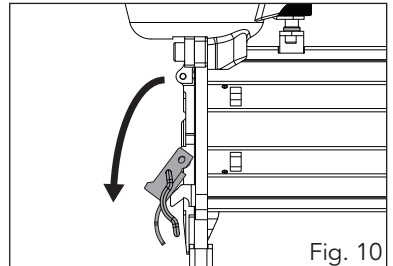

4. Pivot front guide forward. Use a flat blade screwdriver (not included) to remove the jam (fig. 11)
5. Close the front guide and lock the front guide latch.

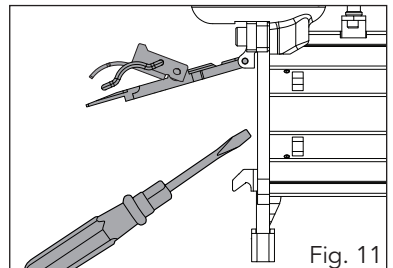

MAINTENANCE



WARNING! Disconnect the tool from the air supply and empty the magazine before carrying out any maintenance procedure or troubleshooting. Failure to do so could result in serious personal injury.

Fitting the bump fire trigger

This can be fitted in four simple steps (fig. 12).

1. Remove the seal from the end of the pin with a pointed tool (not included).
2. Gently lift the seal from the pin and put aside for refitting.
3. Remove pin from trigger and housing. Take care as not to misplace the spring.
4. Replace with the Bump trigger and spring, insert pin and refit the seal to lock in place.

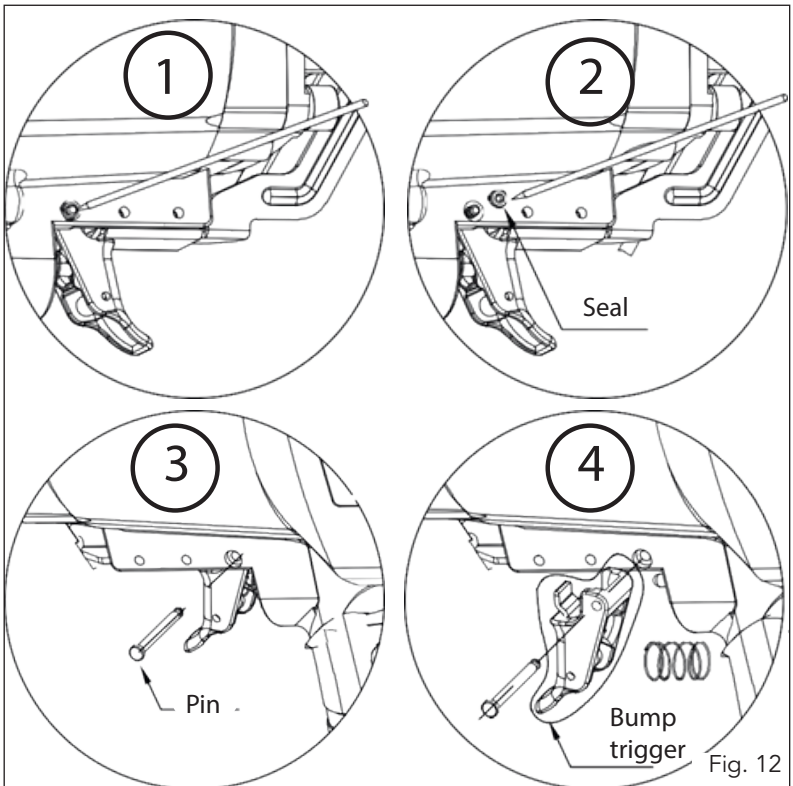

MAINTENANCE (cont.)

- If the enclosure of the tool requires cleaning, do not use solvents but a moist soft cloth only. Never let any liquid get inside the tool; never immerse any part of the tool into a liquid.
- Store the tool in a dry and safe place out of reach of children.
- Oil the air tool after each use with air tool oil.
- After approximately 300,000 nails, the air gun will require servicing. If any servicing or repairs are required, the tool must be serviced by a qualified repairs agent.

Note: TB Imports will not be responsible for any damage or injuries caused by the repair of the tool by an unauthorised person or by mishandling of the tool.







Spare Parts

Limited spare parts are available subject to availability. Please contact your local Bunnings Special Orders Desk to order the required spare parts.

TROUBLESHOOTING

PROBLEM	POSSIBLE CAUSE	POSSIBLE REMEDY
Air leak near the top of the tool or in the trigger area.	Loose screws	Tighten screws
	Worn or damaged o-rings or seals	Check/replace o-rings
Air leak near the base of the tool	Loose screws	Tighten screws
	Worn or damages o-rings or seals	Replace with new
Tool does nothing or operates sluggishly	Insufficient air supply	Increase air flow to tool (Do not exceed 120psi)
	Insufficient lubrication	Lubricate tool
	Worn or damaged o-rings	Check/replace o-rings
Fasteners jam frequently	Incorrect fasteners	Check magazine for correct fasteners
	Damaged fasteners	Replace fasteners
	Dirty magazine	Clean magazine
Fastener will not drive completely into the workpiece	Insufficient air supply	Increase air flow to tool (Do not exceed 120psi)
	Safety striker set incorrectly	See Depth drive adjustment
Fasteners penetrate properly during normal operation, but won't drive fully at faster speeds.	Insufficient air supply	Increase air flow to tool (Do not exceed 120psi)
		Use larger air lines (3/8" I/D minimum)
Fastener drive is too deep	Air pressure too high	Reduce air pressure
	Safety striker set incorrectly	See Depth drive adjustment
Tools skips during operation - no fasteners are driven from time to time	Incorrect fasteners	Check magazine for correct fasteners
	Dirty magazine or magazine cover	Magazine cover should slid freely. Clean as needed to remove debris
	Insufficient air supply	Use larger air lines (3/8" I/D minimum)

DESCRIPTION OF SYMBOLS

	Warning	n_0	No load speed
\emptyset	Diameter		
/min	Revolutions or reciprocations per minute		Wear hearing protection
		Read Instruction Manual	
	<p>Warning, this nail gun has contact actuation mode (bump fire) Its intended uses are for production applications such as pallets, furniture, manufactured housing, upholstery and sheathing. Do not use this tool in bump fire mode for applications such as closing boxes or crates and fitting transportation safety systems on trailers and lorries. Take extra care when changing from one driving location to another in bump fire mode and always disconnect the air supply when not in use.</p>		

CARING FOR THE ENVIRONMENT



Power tools that are no longer usable should not be disposed of with household waste but in an environmentally friendly way. Please recycle where facilities exist. Check with your local council authority for recycling advice.



Recycling packaging reduces the need for landfill and raw materials. Reuse of recycled material decreases pollution in the environment. Please recycle packaging where facilities exist. Check with your local council authority for recycling advice.

CONTENTS

1 x Air Brad nail gun
2 x Hex keys (3, 4mm)
1 x Bump fire trigger

1 x Oil bottle only
1 x Instruction manual
1 x Spare Drive Guide

Note: The manufacturer's liability shall be deemed void if the tool is modified in any way and the manufacturer shall therefore accept no liability for any damages arising as a result of modifications.

Distributed by:
TB Imports

AUSTRALIA (Head Office)

25 Fox Drive, Dandenong South, Victoria, Australia, 3175

Telephone: 1800 951 371 (AUS), 0800 647 840 (NZ)

WARRANTY

YOUR WARRANTY FORM SHOULD BE RETAINED BY YOU AT ALL TIMES. IN ORDER TO MAKE A CLAIM UNDER THIS WARRANTY YOU MUST RETURN THE PRODUCT TO YOUR NEAREST BUNNINGS WAREHOUSE (see www.bunnings.com.au or www.bunnings.co.nz for store locations) WITH YOUR BUNNINGS REGISTER RECEIPT. PRIOR TO RETURNING YOUR PRODUCT FOR WARRANTY PLEASE TELEPHONE OUR CUSTOMER SERVICE HELPLINE:

**Australia 1800 951 371
New Zealand 0800 647 840**

TO ENSURE A SPEEDY RESPONSE PLEASE HAVE THE MODEL NUMBER AND DATE OF PURCHASE AVAILABLE. A CUSTOMER SERVICE REPRESENTATIVE WILL TAKE YOUR CALL AND ANSWER ANY QUESTIONS YOU MAY HAVE RELATING TO THE WARRANTY POLICY OR PROCEDURE.

1 YEAR WARRANTY

Your product is guaranteed for a period of **12 months from the original date of purchase**. If a product is defective it will be repaired in accordance with the terms of this warranty. Warranty excludes consumable parts, for example: wheels, bearings.

The benefits provided under this warranty are in addition to other rights and remedies which are available to you under law. The warranty covers manufacturer defects in materials, workmanship and finish under normal use.

Our goods come with guarantees that cannot be excluded under Australian Consumer law & Consumer Guarantees Act 1993 (NZ). You are entitled to a replacement or refund for a major failure and to compensation for other reasonably foreseeable loss or damage. You are also entitled to have the goods repaired and replaced if the goods fail to be of acceptable quality and the failure does not amount to a major failure.

WARRANTY EXCLUSIONS

The following actions will result in the warranty being void.

- If the tool has been operated on a supply voltage other than that specified on the tool.
- If the tool shows signs of damage or defects caused by or resulting from abuse, accidents or alterations.
- Failure to perform maintenance as set out within the instruction manual.
- If the tool is disassembled or tampered with in any way.
- The warranty excludes damage resulting from product misuse or product neglect.

This warranty is given by TB Imports.

ABN: 17 050 731 756

Ph. 1800 951 371 (AUS)

0800 647 840 (NZ)

Australia/New Zealand (Head Office)
25 Fox Drive, Dandenong South, Victoria, Australia 3175