





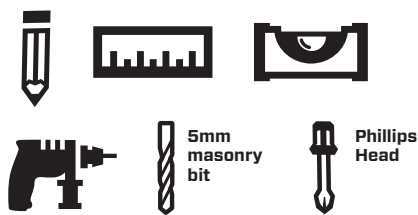

Photo Shelf Installation Instructions

Parts List

A  x2pcs	B  x2pcs
C  x2pcs	D  x2pcs

Tools Required



Capacity

Weight load capacity can vary based on the type of wall you're affixing the shelf to. As a guideline please see below:



* LOAD EVENLY DISTRIBUTED

Step 1

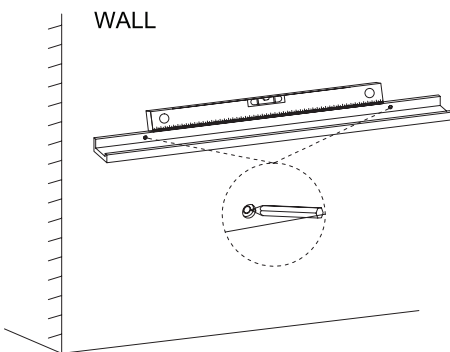

Step 2

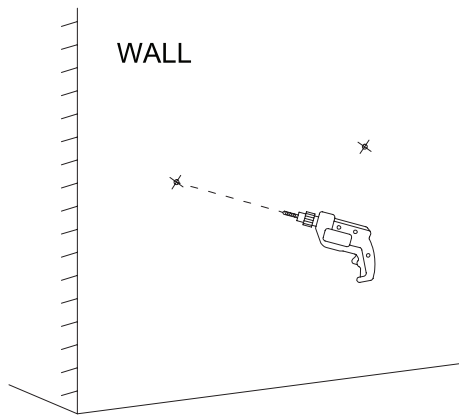

Step 3

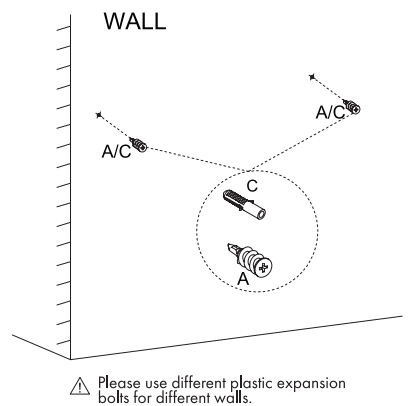

⚠ Please use different plastic expansion bolts for different walls.

Step 4

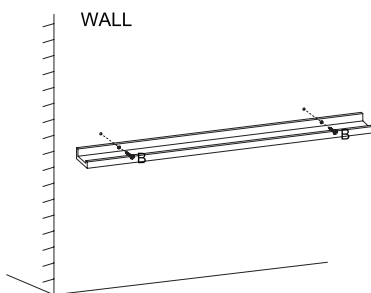

Step 5

