

# ozito

## AIRLESS PAINT SPRAYER

### 700W

### INSTRUCTION MANUAL

#### SPECIFICATIONS

|                         |                    |
|-------------------------|--------------------|
| Input Power:            | 700W               |
| Voltage:                | 220-240V ~50Hz     |
| Max. Pressure:          | 3,000psi (21MPa)   |
| Max. Flow Rate:         | 1.0L/min           |
| Spray Tip Size:         | 517 (Supplied)     |
| Suitable Spray Tips:    | 0.013 - 0.021"     |
| Max. Viscosity:         | 100DIN-s           |
| Outlet Paint Connector: | G¼"-19"            |
| Max. Hose Pressure:     | 3,300psi (22.8MPa) |
| High Pressure Hose:     | 7.5m               |
| Paint Temperature:      | 5-40°C             |
| Weight:                 | 10.5kg             |

ozito.com.au

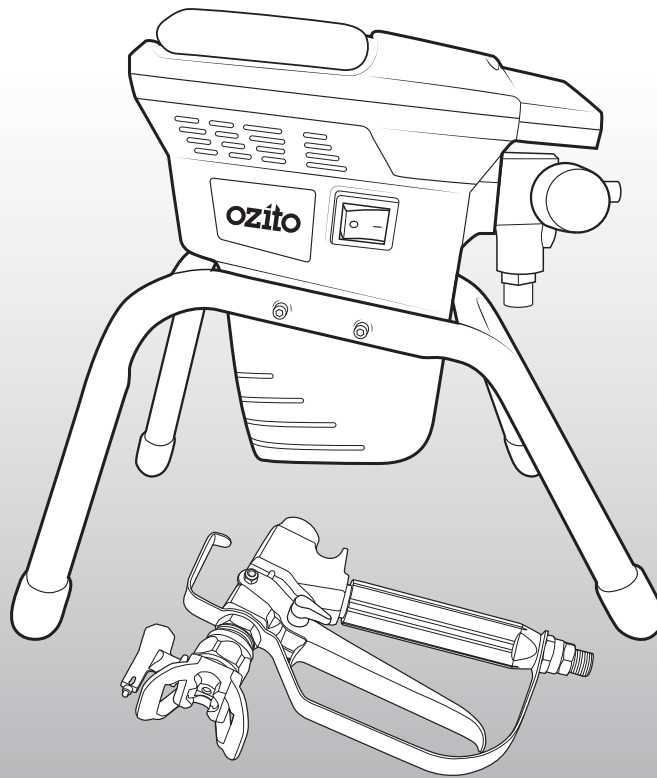

#### STANDARD EQUIPMENT

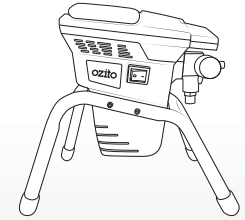

Airless Sprayer

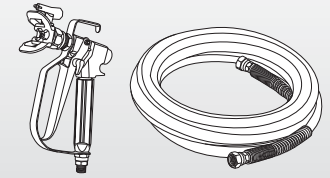

Spray Gun & High Pressure Hose

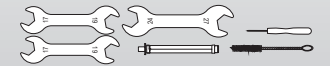

3 x Spanners, Spare Spray Gun  
Filter, Fine Needle & Cleaning  
Brush



4 x Bolts, 4 x Washers, 4 x Spring  
Washers & Hex Key

# 1 YEAR REPLACEMENT WARRANTY

## ASG-7000

### WARRANTY

IN ORDER TO MAKE A CLAIM UNDER THIS WARRANTY YOU MUST RETURN THE PRODUCT TO YOUR NEAREST BUNNINGS WAREHOUSE WITH YOUR BUNNINGS REGISTER RECEIPT. PRIOR TO RETURNING YOUR PRODUCT FOR WARRANTY PLEASE TELEPHONE OUR CUSTOMER SERVICE HELPLINE:

**Australia 1800 069 486**

**New Zealand 0508 069 486**

TO ENSURE A SPEEDY RESPONSE PLEASE HAVE THE MODEL NUMBER AND DATE OF PURCHASE AVAILABLE. A CUSTOMER SERVICE REPRESENTATIVE WILL TAKE YOUR CALL AND ANSWER ANY QUESTIONS YOU MAY HAVE RELATING TO THE WARRANTY POLICY OR PROCEDURE.

The benefits provided under this warranty are in addition to other rights and remedies which are available to you at law. Our goods come with guarantees that cannot be excluded at law. You are entitled to a replacement or refund for a major failure and for compensation for any other reasonably foreseeable loss or damage. You are also entitled to have the goods repaired or replaced if the goods fail to be of acceptable quality and the failure does not amount to a major failure.

Generally you will be responsible for all costs associated with a claim under this warranty, however, where you have suffered any additional direct loss as a result of a defective product you may be able to claim such expenses by contacting our customer service helpline above.

#### 1 YEAR REPLACEMENT WARRANTY

Your product is guaranteed for a period of **12 months from the original date of purchase** and is intended for DIY (Do It Yourself) use only. If a product is defective it will be replaced in accordance with the terms of this warranty. Warranty excludes consumable parts, for example: valve adapters and accessories.

#### WARNING

**The following actions will result in the warranty being void.**

- If the tool has been operated on a supply voltage other than that specified on the tool.
- If the tool shows signs of damage or defects caused by or resulting from abuse, accidents or alterations.
- Failure to perform maintenance as set out within the instruction manual.
- If the tool is disassembled or tampered with in any way.
- Professional, industrial or high frequency use.

# KNOW YOUR PRODUCT

## AIRLESS SPRAY GUN

- |                      |                           |
|----------------------|---------------------------|
| 1. Carry Handle      | 11. Inlet Hose Port       |
| 2. Paint Outlet Port | 12. Pressure Control Dial |
| 3. Power Cord        | 13. On/Off Switch         |
| 4. Priming Lever     | 14. Handle                |
| 5. Return Pipe Port  | 15. Spray Gun Inlet       |
| 6. Frame             | 16. Spray Gun Trigger     |
| 7. Return Pipe       | 17. Handle Guard          |
| 8. Inlet Filter      | 18. Tip Guard             |
| 9. Inlet Hose        | 19. Spray Tip             |
| 10. Sprayer Unit     | 20. Trigger Locking Lever |

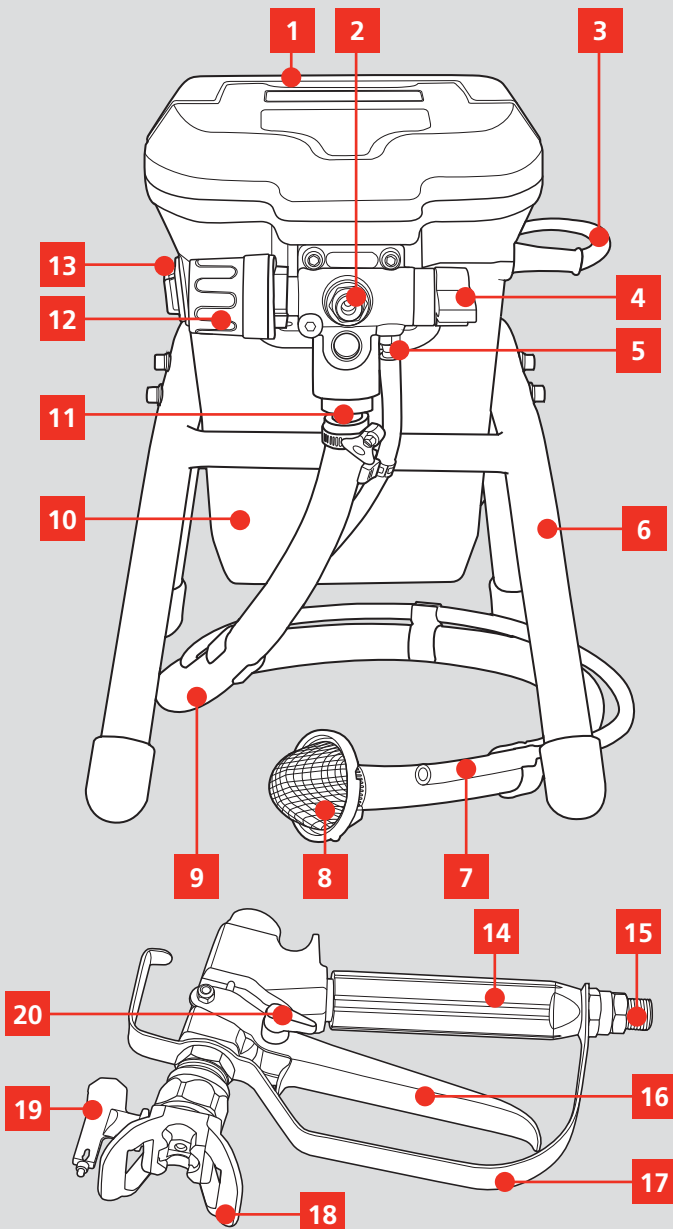

### ONLINE MANUAL

Scan this QR Code with your mobile device to take you to the online manual.



# SETUP & PREPARATION

## 1. ASSEMBLY



**WARNING!** ENSURE THE TOOL IS TURNED OFF AND DISCONNECTED FROM THE POWER SUPPLY BEFORE PERFORMING ANY OF THE FOLLOWING OPERATIONS.

### Frame Connection

1. Insert the paint station into the frame, aligning the 4 bolt holes (2 either side).

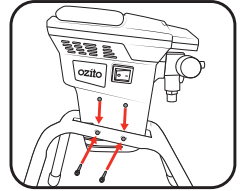

2. Place a spring washer and then a washer onto each bolt. Insert the bolt assemblies into the bolt holes and tighten using the supplied hex key.

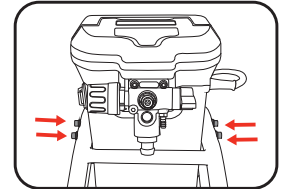

### Hose Connection

**Note:** The air caps on the paint station and air hose will need to be removed prior to connection.

1. Connect the high pressure hose to the paint outlet and tighten clockwise.

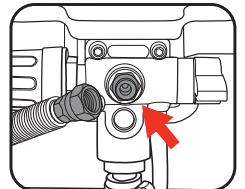

2. Connect the other end of hose to the gun inlet and tighten clockwise.

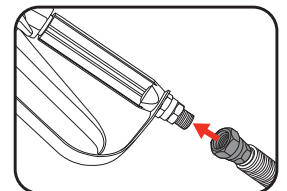

3. Ensure all connections have been correctly tightened with a 19mm spanner on the hose, and a 17mm spanner to hold the connection.

4. Connect the inlet hose and return pipe to the paint station.

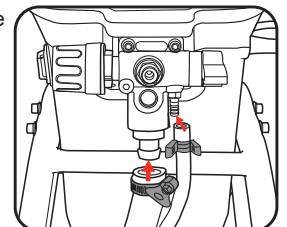

5. Secure the inlet hose by tightening the screw on the hose clamp.

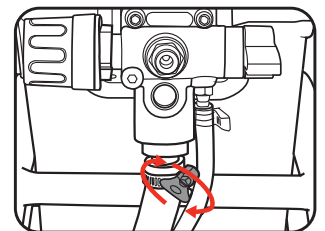

# 1

## YEAR REPLACEMENT WARRANTY

## Spray Tip & Guard

**Note:** The spray gun comes assembled from the factory. If the spray gun has been disassembled for cleaning or priming, follow the steps below to re-assemble.

1. Push the mesh filter into the spray head and then insert the handle over the mesh filter.

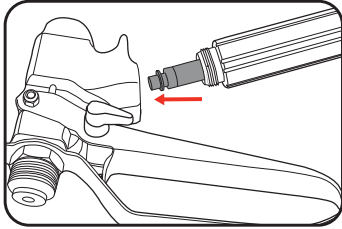

2. Ensure the trigger guard is attached to the handle and tighten the handle using a 19mm spanner.

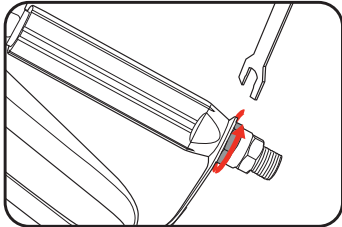

3. Screw the tip guard loosely onto the spray gun and insert the spray tip into the tip guard.

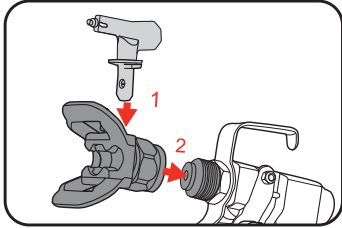

4. Fully tighten the tip guard onto the spray gun with the 27mm spanner.

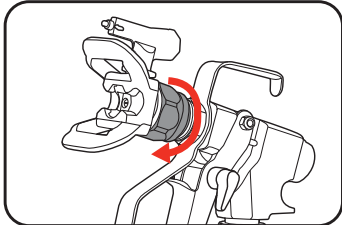

## 2. PREPARING THE MACHINE

**WARNING!** THE TOOL IS RECOMMENDED FOR USE WITH A RESIDUAL CURRENT DEVICE WITH A RATED CURRENT OF 30mA OR LESS.

**WARNING!** ENSURE THE TOOL IS TURNED OFF AND DISCONNECTED FROM THE POWER SUPPLY BEFORE PERFORMING ANY OF THE FOLLOWING OPERATIONS.

### Locking The Spray Gun Trigger

The spray gun trigger should be locked prior to priming the spray station to prevent accidentally activating the spray gun.

1. To lock the spray gun trigger, rotate the trigger locking lever clockwise until it points rearwards.

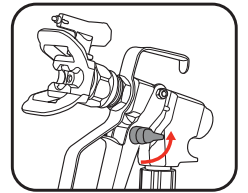

2. To unlock the trigger, rotate the trigger locking lever anti-clockwise.

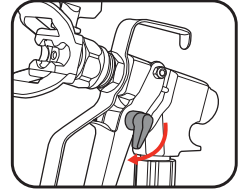

### Paint Preparation

You do not need to thin paint for use in this spray gun. The inlet hose and return pipe can be placed directly into the paint tin for spraying.

For best results we recommend straining the paint prior to use. This will improve the final result by eliminating any contaminants and lumps present in the paint.

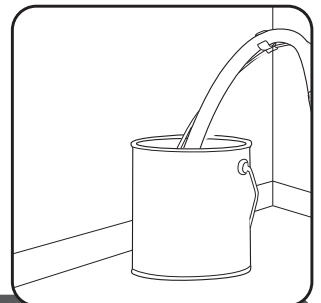

**WARNING!** PAINTING CAN BE MESSY, AND SPRAY MATERIALS MAY BE EMITTED AT HIGH PRESSURE FROM THE SPRAY GUN. WEAR APPROPRIATE SAFETY GEAR AND ENSURE SURFACES YOU DO NOT WANT TO GET PAINT/SPRAY MATERIAL ON ARE ADEQUATELY COVERED AND PROTECTED.

## Priming The Pump

The airless sprayer needs to be primed every time a spray material is used. Whether you are setting the machine up for use after cleaning/storage, changing paint colours, or swapping from a stain to varnish, you will need to follow the priming procedure for the pump and spray gun.

**Note:** When changing between different paint colours, it is recommended to clean the sprayer to prevent paint mixing and for best results.

1. Fully submerge the inlet filter in the spray material.

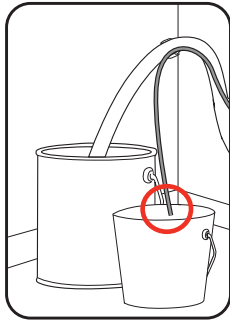

2. To prevent any lubricants or impurities getting into your spray material, hold the return pipe over a waste bucket and continue with the priming steps.

When spray material starts coming out of the return pipe, submerge the return pipe in the spray material tin/bucket with the inlet hose.

2. Set the priming lever to the prime position.

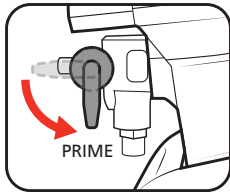

3. Adjust the pressure dial to the maximum position by rotating it clockwise.

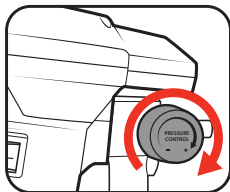

4. Switch on the unit and let the paint cycle through the system for a few minutes.

5. Wait for any air bubbles to clear the return pipe (this is indicated by a steady stream of paint out of return pipe) then switch off the unit.

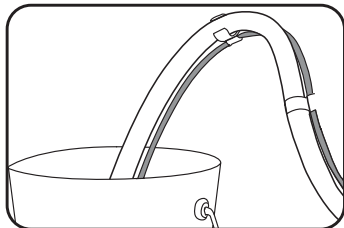

## Priming The Spray Gun & High Pressure Hose

1. Remove the tip guard and spray tip from the spray gun.

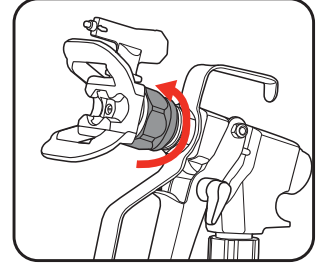

2. Set the priming lever to the spray position.

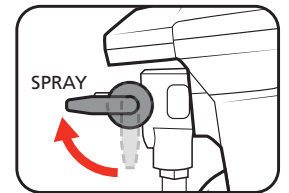

3. Point the spray gun nozzle into a waste bucket, then press and hold the trigger to relieve the pressure in the line.

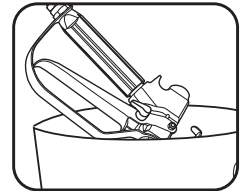

4. While still holding down the trigger, switch on the unit.

5. Keep holding down the trigger until spray material is emitted from the spray gun, at which point direct the spray gun back into the spray material tin for a few seconds. Release the spray gun trigger.

8. **Switch off the unit.**

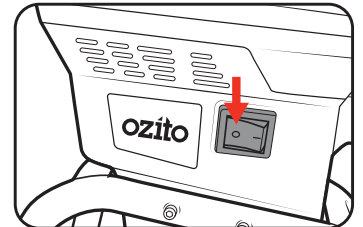

9. Re-assemble the spray tip and tip guard. The sprayer is now ready to use.

**Note:** The motor automatically shuts off once the operating pressure is reached and will start-up again when it drops below the cut-in pressure. This is part of normal operation and does not indicate a fault with the machine.

# OPERATION

## 3. CONTROLS

**WARNING!** WEAR APPROPRIATE SAFETY GEAR INCLUDING EYE, EAR AND BREATHING PROTECTION BEFORE COMMENCING USE.

### Adjusting The Spray Pressure

The spray pressure setting required will vary depending on many factors such as the viscosity of the material, the temperature, the wear on the spray tip, size of the nozzle, distance to the work surface, length of the hose, etc. It will therefore need to be adjusted until an even spray pattern is achieved before starting to paint.

1. Set the pressure control dial to approximately medium pressure.

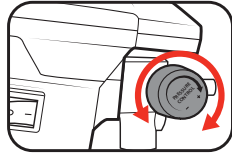

2. Test this pressure setting on a scrap piece of material. Too little pressure will result in streaks with more paint appearing in the spray pattern.

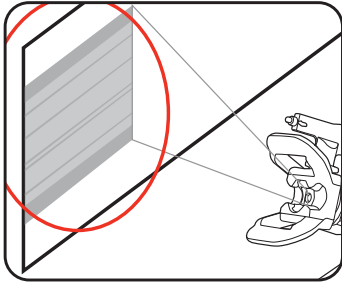

Too much pressure will result in overspray, material wastage and premature wear on the airless sprayer parts.

**Note:** As best practice, it is recommended to start at a lower pressure and then adjust it up until the streaks start to disappear and an even spray output is achieved.

3. Continue adjusting the pressure setting and testing it until a smooth even consistency is achieved.

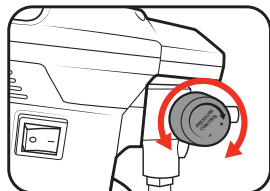

**Note:** Take note of how far the sprayer is held from the test surface whilst testing, as this will affect obtaining an even spray output. You will want to maintain this distance when spraying the work surface.

**Note:** If the streaks are still present even at maximum pressure, a narrower spray tip may be required.

### Adjusting Spray Speed

The selected spray pressure will affect the speed at which you'll need to move the spray gun. Lower pressures will require slower speeds and higher pressures, faster speeds.

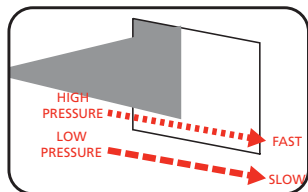

1. On a scrap piece of material, practice applying steady strokes at the speed required to achieve an even spray pattern.

### Pressure Release Procedure

**WARNING!** PERFORM THE FOLLOWING PROCEDURE FOR PRESSURE RELEASE WHEN SHUTTING DOWN THE AIRLESS SPRAYER FOR ANY PURPOSE, INCLUDING CLEANING OR ADJUSTING.

1. With the machine switched on, rotate the priming lever into the prime position.

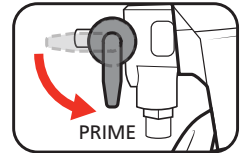

2. Switch off the spray system.

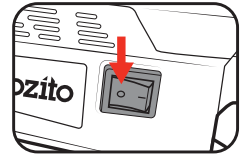

3. Aim the spray gun into the paint bucket and squeeze the trigger to release any remaining pressure in the gun. Keep holding the trigger until the spray material comes out.

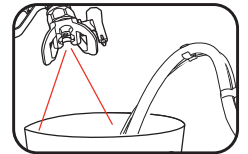

4. Lock the spray gun trigger.

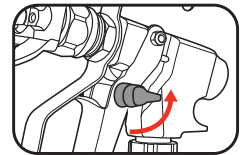

### Changing The Spray Direction

1. Perform the **Pressure Release Procedure** described above.

**WARNING!** ENSURE THE TOOL IS SWITCHED OFF & THE CORD IS UNPLUGGED WHEN PERFORMING THE OPERATION BELOW.

2. Rotate the tip guard to match the direction of preferred spray pattern.

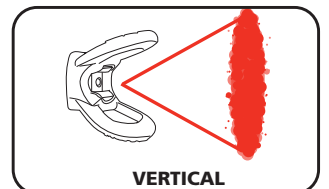
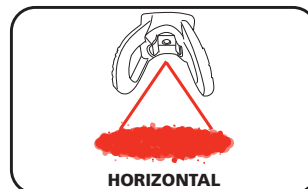
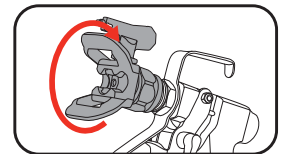

3. Flip the priming lever back into the spray position and switch the unit on. The sprayer is now ready for use again.

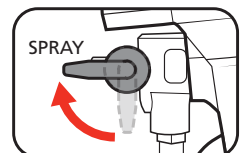

## 4. USING THE SPRAYER

**WARNING!** ENSURE THAT THE AIRLESS SPRAYER HAS BEEN PROPERLY PRIMED BEFORE COMMENCING SPRAYING PROCEDURE.

### Spraying Technique

The spraying result depends considerably on how well prepared the surface is for painting. Carefully complete proper surface preparation according to the paint manufacturer's instructions.

1. Turn the airless sprayer on. Ensure the priming lever is in the spray position. Release the trigger lock.

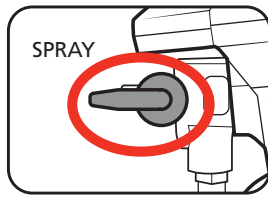

2. Keep the spray gun perpendicular to the surface.

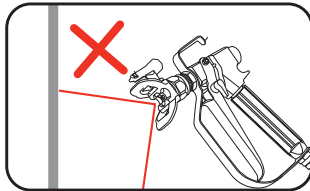
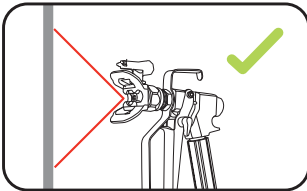

3. Move the gun with the entire arm, not by flexing the wrist. This will keep the spray gun at right angles to the surface, keeping the pattern even.

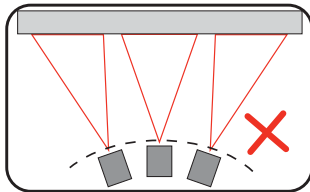
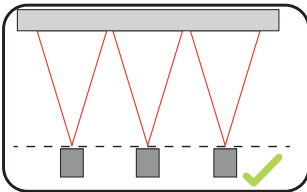

4. Start the stroke before the edge of the area being sprayed. Begin the movement and then squeeze the trigger.

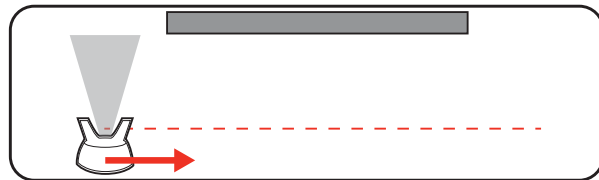

5. Move the spray gun along the surface at a steady pace and then release the trigger once past the opposite edge of the area being sprayed.

6. Overlap each stroke to ensure even coverage.

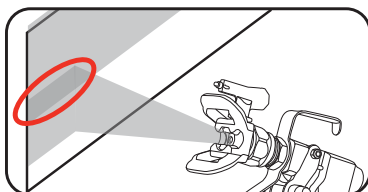

### Helpful Hints

1. Do not spray outdoors on a windy day as the results may be unsatisfactory.
2. Only apply one coat at a time, always allow a coat to completely dry before adding another coat.
3. Avoid stopping and starting as this can lead to a patchy finish. It is best to start spraying outside the surface to be sprayed and avoid stopping in the middle of the surface, continue just past the opposite edge.
4. If no spray comes out of the spray gun, the tip may have dried and clogged. Switch off the unit, lock the spray gun trigger and rotate the spray tip by 180°. Switch on the unit, unlock the trigger then squeeze and hold the trigger to spray material through the gun. Repeat this 2-3 times.

If the procedure above does not fix the issue, Switch off the unit and follow the cleaning procedure for the spray tip in the 'CLEANING THE SPRAY GUN' section of the **Cleaning & Maintenance Manual**.

### Interim Procedure

If you are taking a break for more than several minutes, follow the procedure below to prevent paint from drying and forming a blockage in the spray gun.

1. Perform the **Pressure Release Procedure** described in the 'CONTROLS' section.
2. Remove the spray tip from the spray gun and submerge it in a container of the appropriate solvent (water if water based spray material was used, or a suitable cleaning solution if oil based).
3. When you are ready to start spraying again, wipe the spray tip dry, re-assemble the spray gun, prime the machine again and resume use as normal

**WARNING!** IF YOU ARE TAKING A BREAK, YOU WILL NEED TO PERFORM THE CLEANING PROCEDURE ON THE UNIT. DO NOT LEAVE SPRAY MATERIAL SITTING IN THE UNIT AS THIS CAN DRY AND CLOG THE PARTS, RENDERING THE SPRAYER INOPERABLE.

### Clean After Each Use





Follow the cleaning procedure in the separate cleaning manual **IMMEDIATELY AFTER each use**. Ensure the unit is thoroughly cleaned before storing to prevent build up of dried paint which can cause blockages and stop the unit from working.

**WARNING!** NOT FOLLOWING THE CLEANING STEPS WILL RESULT IN THE MACHINE CLOGGING AND BREAKAGE. MALFUNCTIONS CAUSED BY FAILURE TO FOLLOW CLEANING PROCEDURES ARE NOT COVERED BY THE PRODUCT WARRANTY.

## 5. TROUBLESHOOTING

| Symptom  | Possible Cause  | Suggested Solution  |
|--|---|---|
| Little or no material flow                             | Nozzle clogged  | Follow instructions in the Cleaning Manual for cleaning the spray tip |
|  | Suction tube clogged  | Clean   |
|  | Pressure control dial turned too low                                      | Increase pressure control dial setting                                |
|  | Suction tube loose  | Insert & tighten the hose clamp                                       |
|  | Inlet filter clogged  | Clean or replace  |
| Material leaking                                       | Nozzle loose  | Tighten   |
|  | Nozzle worn   | Replace   |
|  | Nozzle seal worn  | Replace   |
|  | Material build-up on air cap & nozzle                                     | Clean   |
| Atomisation is too coarse                              | Larger tip & filter required  | Refer to spray tip selection chart                                    |
|  | Material volume too large   | Decrease pressure control dial setting                                |
|  | Nozzle clogged  | Clean   |
|  | Inlet filter clogged  | Clean or replace  |
| Pattern runs or sags                                   | Applying too much material  | Adjust pressure control dial or increase movement speed of spray gun  |
| Too much overspray                                     | Gun too far from spray object   | Reduce distance   |
|  | Too much material applied   | Decrease pressure control dial setting                                |
| Pattern is very light & splotchy                       | Moving the spray gun too fast   | Adjust pressure control dial or decrease movement speed of spray gun  |
| Spluttering paint                                      | Air bubbles in the return pipe  | Follow priming instructions to remove air bubbles                     |
| Inlet hose not sucking up water when cleaning the unit | Lack of pressure  | Follow priming instructions to re-prime the unit                      |
| Machine not priming                                    | Spray gun tip is clogged  | Clean spray gun tip   |
|  | Spray gun filter is clogged   | Clean spray gun filter  |
|  | Priming lever is not set to prime   | Set priming lever to prime  |
|  | Paint outlet & inlet are clogged  | Clean paint outlet & inlet  |
|  | Pressure too low  | Set pressure control dial higher                                      |
|  | Inlet filter is clogged   | Clean inlet filter  |
| Paint station is starting & stopping automatically     | This is normal; this ensures the correct operating pressure is maintained | No issue  |

## DESCRIPTION OF SYMBOLS

|   |                                      |   |                       |
|---|--------------------------------------|---|-----------------------|
| <b>V</b>  | Volts                                | <b>Hz</b>   | Hertz                 |
| <b>~</b>  | Alternating Current                  | <b>W</b>  | Watts                 |
| <b>L/min</b>  | Litres per minute                    | <b>psi</b>  | Pound per square inch |
|  | Wear eye, ear & breathing protection | <b>MPa</b>  | Megapascals           |
|  | Regulatory Compliance Mark (RCM)     |  | Warning               |
|  | Read Instruction Manual              |   |                       |

## CARING FOR THE ENVIRONMENT



Power tools that are no longer usable should not be disposed of with household waste but in an environmentally friendly way. Please recycle where facilities exist. Check with your local council authority for recycling advice.



Recycling packaging reduces the need for landfill and raw materials. Reuse of recycled material decreases pollution in the environment. Please recycle packaging where facilities exist. Check with your local council authority for recycling advice.

## SPARE PARTS

Spare parts can be ordered from the Special Orders Desk at your local Bunnings Warehouse.

For further information, or any parts not listed here, visit

[www.ozito.com.au](http://www.ozito.com.au) or contact Ozito Customer Service:

**Australia 1800 069 486**

**New Zealand 0508 069 486**

**E-mail: [enquiries@ozito.com.au](mailto:enquiries@ozito.com.au)**

# ELECTRICAL SAFETY



**WARNING!** When using mains-powered tools, basic safety precautions, including the following, should always be followed to reduce risk of fire, electric shock, personal injury and material damage.

Read the whole manual carefully and make sure you know how to switch the tool off in an emergency, before operating the tool.

Save these instructions and other documents supplied with this tool for future reference.

The charger has been designed for 230V and 240V only. Always check that the power supply corresponds to the voltage on the rating plate.

**Note:** The supply of 230V and 240V on Ozito tools are interchangeable for Australia and New Zealand.

If the supply cord is damaged, it must be replaced by an electrician or a power tool repairer in order to avoid a hazard.

## Using an Extension Lead

Always use an approved extension lead suitable for the power input of this tool. Before use, inspect the extension lead for signs of damage, wear and ageing. Replace the extension lead if damaged or defective. When using an extension lead on a reel, always unwind the lead completely. Use of an extension lead not suitable for the power input of the tool or which is damaged or defective may result in a risk of fire and electric shock.

The power supply for this products charger should be protected by a residual current device (rated at 30mA or less). A residual current device reduces the risk of electric shock.

# GENERAL POWER TOOL SAFETY WARNINGS



**WARNING!** Read all safety warnings and all instructions. Failure to follow the warnings and instructions may result in electric shock, fire and/or serious injury.

Save all warnings and instructions for future reference. The term "power tool" in the warnings refers to your mains-operated (corded) power tool or battery-operated (cordless) power tool.

1. Work area safety

**a. Keep work area clean and well lit.** Cluttered or dark areas invite accidents.

**b. Do not operate power tools in explosive atmospheres, such as in the presence of flammable liquids, gases or dust.** Power tools create sparks which may ignite the dust or fumes.

**c. Keep children and bystanders away while operating a power tool.** Distractions can cause you to lose control.

2. Electrical safety

**a. Power tool plugs must match the outlet. Never modify the plug in any way. Do not use any adapter plugs with earthed (grounded) power tools.** Unmodified plugs and matching outlets will reduce risk of electric shock.

**b. Avoid body contact with earthed or grounded surfaces, such as pipes, radiators, ranges and refrigerators.** There is an increased risk of electric shock if your body is earthed or grounded.

**c. Do not expose power tools to rain or wet conditions.** Water entering a power tool will increase the risk of electric shock.

**d. Do not abuse the cord. Never use the cord for carrying, pulling or unplugging the power tool. Keep cord away from heat, oil, sharp edges or moving parts.** Damaged or entangled cords increase the risk of electric shock.

**e. When operating a power tool outdoors, use an extension cord suitable for outdoor use.** Use of a cord suitable for outdoor use reduces the risk of electric shock.

3. Personal safety

**a. Stay alert, watch what you are doing and use common sense when operating a power tool. Do not use a power tool while you are tired or under the influence of drugs, alcohol or medication.** A moment of inattention while operating power tools may result in serious personal injury.

**b. Use personal protective equipment. Always wear eye protection.** Protective equipment such as dust mask, non-skid safety shoes, hard hat, or hearing protection used for appropriate conditions will reduce personal injuries.

**c. Prevent unintentional starting. Ensure the switch is in the off-position before connecting to power source and/or battery pack, picking up or carrying the tool.** Carrying power tools with your finger on the switch or energising power tools that have the switch on invites accidents.

**d. Remove any adjusting key or wrench before turning the power tool on.** A wrench or a key left attached to a rotating part of the power tool may result in personal injury.

**e. Do not overreach. Keep proper footing and balance at all times.** This enables better control of the power tool in unexpected situations.

**f. Dress properly. Do not wear loose clothing or jewellery. Keep your hair, clothing and gloves away from moving parts.** Loose clothes, jewellery or long hair can be caught in moving parts.

**g. If devices are provided for the connection of dust extraction and collection facilities, ensure these are connected and properly used.** Use of dust collection can reduce dust-related hazards.

**h. Do not let familiarity gained from frequent use of tools allow you to become complacent and ignore tool safety principles.** A careless action can cause severe injury within a fraction of a second.

4. Power tool use and care

**a. Do not force the power tool. Use the correct power tool for your application.** The correct power tool will do the job better and safer at the rate for which it was designed.

**b. Do not use the power tool if the switch does not turn it on and off.** Any power tool that cannot be controlled with the switch is dangerous and must be repaired.

**c. Disconnect the plug from the power source and/or the battery pack from the power tool before making any adjustments, changing accessories, or storing power tools.** Such preventive safety measures reduce the risk of starting the power tool accidentally.

**d. Store idle power tools out of the reach of children and do not allow persons unfamiliar with the power tool or these instructions to operate the power tool.** Power tools are dangerous in the hands of untrained users.

**e. Maintain power tools.** Check for misalignment or binding of moving parts, breakage of parts and any other condition that may affect the power tool's operation. If damaged, have the power tool repaired before use. Many accidents are caused by poorly maintained power tools.

**f. Keep cutting tools sharp and clean.** Properly maintained cutting tools with sharp cutting edges are less likely to bind and are easier to control.

**g. Use the power tool, accessories and tool bits etc. in accordance with these instructions, taking into account the working conditions and the work to be performed.** Use of the power tool for operations different from those intended could result in a hazardous situation.

**h. Keep handles and grasping surfaces dry, clean and free from oil and grease.** Slippery handles and grasping surfaces do not allow for safe handling and control of the tool in unexpected situations.

5. Service

**a. Have your power tool serviced by a qualified repair person using only identical replacement parts.** This will ensure that the safety of the power tool is maintained.

# AIRLESS SPRAYER SAFETY WARNINGS



**WARNING!** The appliance is not to be used by persons (including children) with reduced physical, sensory or mental capabilities, or lack of experience and knowledge, unless they have been given supervision or instruction.

Young children should be supervised to ensure that they do not play with the appliance.

Before connecting a tool to a power source (mains switch power point receptacle, outlet, etc.) be sure that the voltage supply is the same as that specified on the nameplate of the tool. A power source with a voltage greater than that specified for the tool can result in serious injury to the user, as well as damage to the tool. If in doubt, do not plug in the tool. Using a power source with a voltage less than the nameplate rating is harmful to the motor.

The ASG-7000 Airless Spray Gun operates at very high pressure. For safe operation the following must be observed at all times.

- Do not point the spray gun at yourself or any other person. Injury from penetration to the skin and paint solvents being injected into the body can result.
- Always check for leaks and correct operation before use. Never operate the spray gun if there are any leaks or faults. Faults or leaks can cause injury.
- Release the pressure when not in use. Pressure can remain in the unit and hose when switched off.
- Always remove the plug from the mains socket before making any adjustments or performing maintenance.
- Recommendations for the use of a residual current device with a rated residual current of 30mA or less.
- NEVER under any circumstances aim the nozzle at another person or animal. In the event of an injury occurring, seek medical advice immediately.
- The spray gun must not be used for spraying flammable paints and solvents with a flash point of less than 21°C.
- Always ensure there is adequate ventilation when spraying.
- The use of ear protection is recommended.
- Eye protection is recommended to keep hazardous vapours and liquids out of eyes.
- Always wear a face mask when spraying.
- Always read the paint manufacturers thinning instructions before using.
- Always keep the spray basket nozzle in place during use. Never allow the spray to come in direct contact with the skin.
- Never immerse the spray gun in liquid. This could lead to electric shock, personal injury and material damage.
- The spray gun must not be cleaned by using flammable liquids with a flash point of less than 21°C.

- NEVER spray near a naked flame, including an appliance pilot light.
- NEVER smoke whilst spraying.
- NEVER allow children to operate or play with the spray gun.
- Before cleaning, always disconnect the appliance from the mains supply.
- After every use ensure you clean your spray gun thoroughly.
- NEVER use the spray gun outside when it is raining.
- Injury where paint or solvent injection into the skin or body occurs can be very serious. Always seek professional medical help and advise the painter or solvents used.
- NEVER use the spray gun without the trigger safety guard fitted.
- NEVER put your hand in front of the gun. Gloves will not provide protection against an injection injury.
- ALWAYS lock the gun trigger, shut the fluid pump off and release all pressure before servicing, clearing the tip guard, changing tips, or leaving unattended. Pressure will not be released by turning off the machine. The PRIME/SPRAY valve or pressure bleed valve must be turned to their appropriate positions to relieve system pressure.
- NEVER use a spray gun without a working trigger lock and trigger guard in place.
- All accessories must be rated at or above the maximum operating pressure range of the sprayer. This includes spray tips, guns, extensions, and hose.
- High-pressure hoses must be checked thoroughly before they are used. Replace any damaged high-pressure hose immediately.
- Never pull on the high-pressure hose to move the device.
- Do not twist the high-pressure hose.
- Do not put the high-pressure hose into solvents. Use only a wet cloth to wipe down the outside of the hose.
- Lay the high-pressure hose in such a way as to ensure that it cannot be tripped over.
- Follow material and solvent manufacturer's warnings and instructions. Be familiar with the coating material's SDS sheet and technical information to ensure safe use.
- Use lowest possible pressure to flush equipment.
- Protective clothing, gloves and possibly skin protection cream are necessary for the protection of the skin. Observe the regulations of the manufacturer concerning coating materials, solvents and cleaning agents in preparation, processing and cleaning units.
- ALWAYS follow the material manufacturer's instructions for safe handling of paint and solvents.
- Do not spray on windy days.
- Never leave this equipment unattended. Keep away from children or anyone not familiar with the operation of airless equipment.



# ozito

## AIRLESS PAINT SPRAYER

**700W**

### CLEANING & MAINTENANCE MANUAL

---

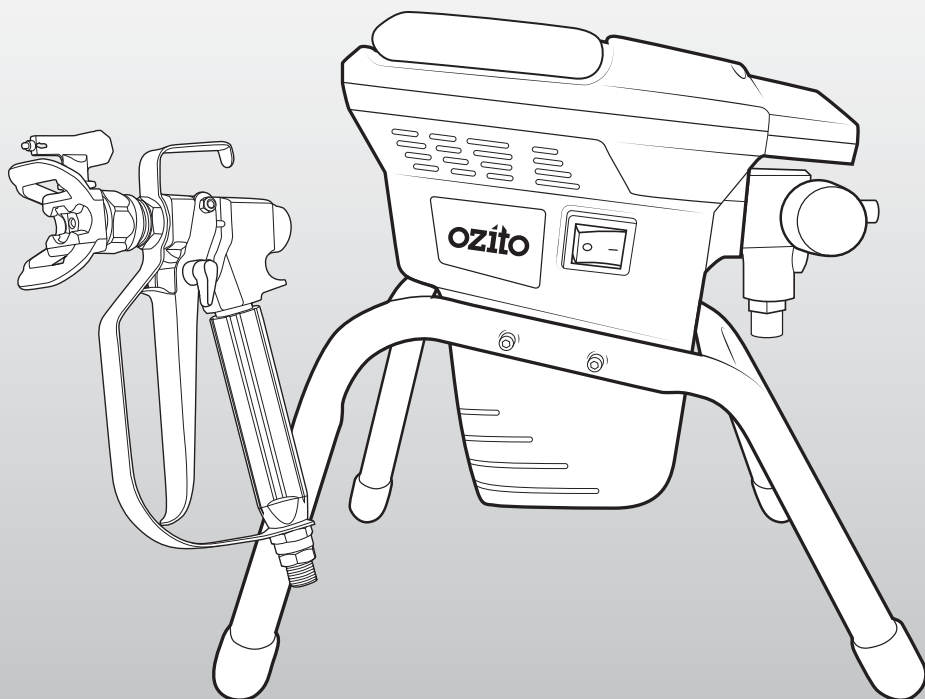

**WARNING!** THE CLEANING PROCESS MUST BE FOLLOWED IMMEDIATELY AFTER USE TO PREVENT PAINT FROM DRYING INSIDE THE PUMP AND HOSE. FAILURE TO FOLLOW THIS INSTRUCTION MAY PERMANENTLY SEIZE THE PAINT SPRAYER.

**ASG-7000**

1219

# CONTENTS

|                                     |         |
|-------------------------------------|---------|
| <b>KNOW YOUR PRODUCT</b> .....      | Page 2  |
| <b>CLEANING</b>                     |         |
| 1. Pressure Release Procedure ..... | Page 4  |
| 2. Solvent Types .....              | Page 5  |
| 3. Rinsing The Inlet Filter .....   | Page 6  |
| 4. Cleaning The Pump .....          | Page 7  |
| 5. Cleaning The Spray Gun .....     | Page 9  |
| <b>MAINTENANCE</b>                  |         |
| 6. Worn Spray Tips .....            | Page 11 |
| 7. Spray Tip Selection .....        | Page 12 |
| 8. Storage .....                    | Page 13 |
| <b>SPARE PARTS</b> .....            | Page 15 |

# KNOW YOUR PRODUCT

## SPRAY GUN

- |                      |                          |
|----------------------|--------------------------|
| 1. Handle            | 5. Tip Guard             |
| 2. Spray Gun Inlet   | 6. Spray Tip             |
| 3. Spray Gun Trigger | 7. Trigger Locking Lever |
| 4. Handle Guard      |                          |

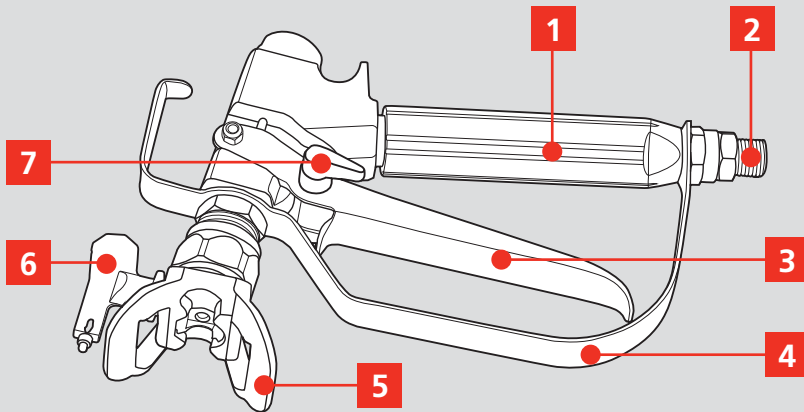

# KNOW YOUR PRODUCT

## AIRLESS PAINT SPRAYER

- 8. Carry Handle
- 9. Paint Outlet Port
- 10. Power Cord
- 11. Priming Lever
- 12. Return Pipe Port
- 13. Frame
- 14. Return Pipe
- 15. Inlet Filter
- 16. Inlet Hose
- 17. Sprayer Unit
- 18. Inlet Hose Port
- 19. Pressure Control Dial
- 20. On/Off Switch

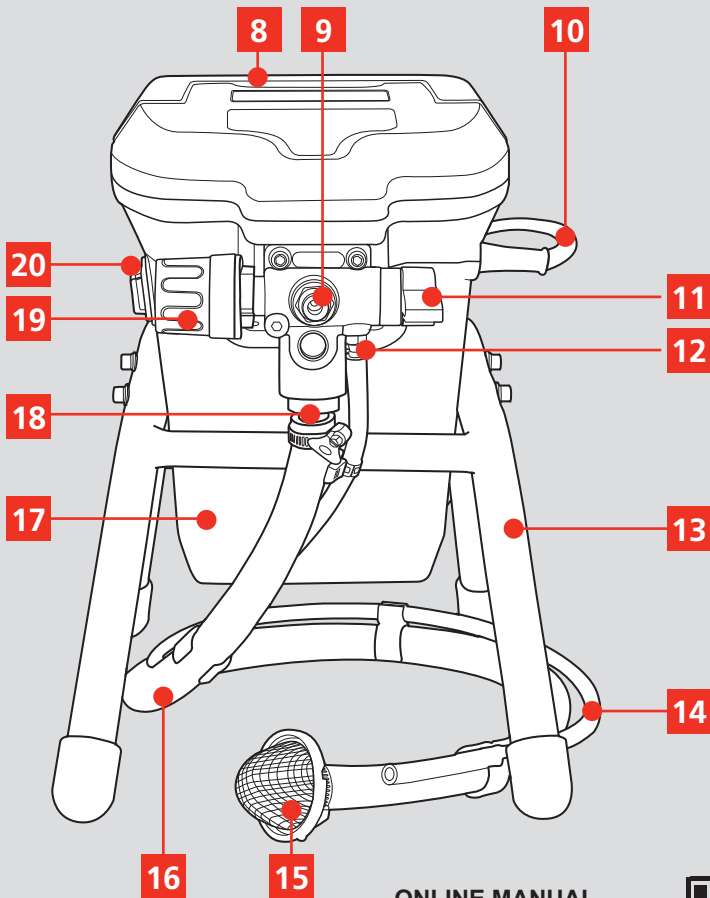

### ONLINE MANUAL

Scan this QR Code with your mobile device to take you to the online manual.



# CLEANING

## 1. PRESSURE RELEASE PROCEDURE



**WARNING!** BEFORE BEGINNING THE CLEANING PROCESS, ENSURE THAT THE PRESSURE RELEASE PROCEDURE BELOW IS PERFORMED.



**WARNING!** ALWAYS WEAR EYE, EAR AND APPROPRIATE BREATHING PROTECTION WHEN CLEANING THE AIRLESS PAINT SPRAYER.



**WARNING!** SPRAY MATERIALS MAY BE EMITTED AT HIGH PRESSURE FROM THE SPRAY GUN. WEAR APPROPRIATE SAFETY GEAR AND ENSURE SURFACES YOU DO NOT WANT TO GET PAINT/SPRAY MATERIAL ON ARE ADEQUATELY COVERED AND PROTECTED.

1. With the machine switched on, rotate the priming lever into the prime position.

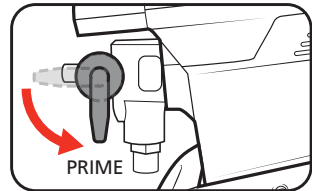

2. Switch off the spray system.

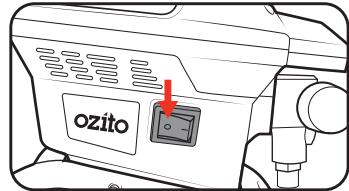

3. Aim the spray gun into the paint bucket and squeeze the trigger to release any remaining pressure in the gun. Keep holding the trigger until the spray material comes out in a small, steady stream.

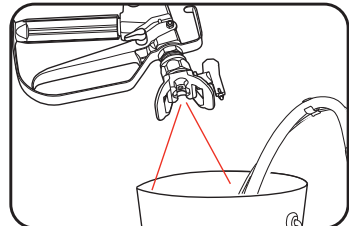

4. Lock the spray gun trigger.

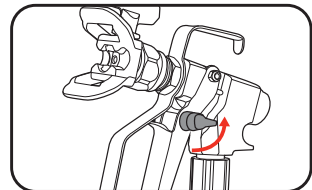

## 2. SOLVENT TYPES



**WARNING!** ALWAYS READ AND FOLLOW THE MANUFACTURER'S INSTRUCTIONS FOR HANDLING AND USE OF THE SOLVENTS. SOME SOLVENTS MAY BE TOXIC AND APPROPRIATE SAFETY MEASURES MUST BE STRICTLY FOLLOWED TO AVOID SAFETY HAZARDS.

### Water Versus Oil Based

If the coating material was water based, use **ONLY** water when performing the cleaning procedure. Use of solvents meant for oil based materials on water based paints will cause the paint residue to harden and block the paint system. This will be extremely difficult to clean.

If coating material was oil based, use **ONLY** the appropriate cleaning solution. Read the cleaning instructions printed on the coating material's label to determine which solvent you need. The following solvents for oil based coating materials are safe to use in the airless paint sprayer:

- Mineral Turpentine
- Paint Thinner

### For Water Based Cleaning

We recommend the use of 30-40 litres when performing the cleaning procedure.

### For Oil Based Cleaning

We recommend 1-2 litres of the appropriate solvent based cleaner when performing the cleaning procedure.

**Note:** Mineral Turpentine **SHOULD NOT** be mixed with water at any stage during the cleaning process.

### 3. RINSING THE INLET FILTER



**WARNING!** BEFORE CLEANING THE MACHINE, ENSURE THE PRESSURE CONTROL DIAL IS SET TO THE MEDIUM SETTING & THE PRIMING LEVER IS SET TO THE 'PRIME' POSITION.



**WARNING!** ENSURE THE TOOL IS SWITCHED OFF & DISCONNECTED FROM THE POWER SUPPLY BEFORE PERFORMING ANY OF THE FOLLOWING OPERATIONS.

1. Lift the inlet hose and return pipe out of the spray material and allow any excess to drip back into the tin/bucket.
2. Unscrew the butterfly clamp on the inlet hose.

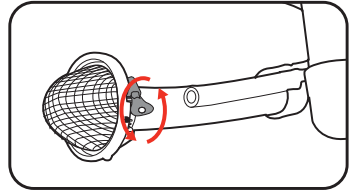

3. Remove the filter and clamp and rinse them out with the appropriate cleaning solution.

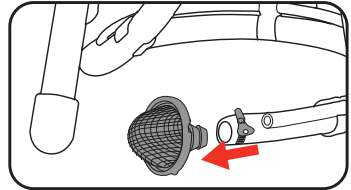

**Note:** If the filter cannot be cleaned it must be replaced.

4. Wipe off any excess spray material from the outside of the inlet hose and return pipe with a dry rag.
5. Re-attach the clamp and filter to the inlet hose and secure in place.

## 4. CLEANING THE PUMP



**WARNING!** THIS CLEANING PROCESS MUST BE FOLLOWED IMMEDIATELY AFTER USE TO PREVENT PAINT FROM DRYING INSIDE THE PUMP & HOSE. FAILURE TO FOLLOW THIS INSTRUCTION MAY PERMANENTLY SEIZE THE PAINT SPRAYER.

1. Prepare 2 buckets, 1 for rinsing and 1 for waste.

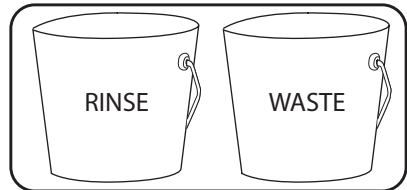

2. Pour a little of the appropriate solvent (water, paint thinner, mineral turpentine) into the waste bucket and place the inlet hose & return pipe in. Allow as much spray material stuck in the hoses to drip out as possible.

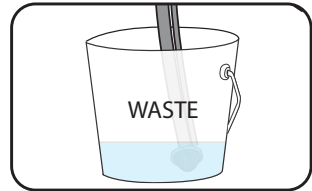

3. Fill the rinsing bucket with some of the solvent and submerge the rinsed inlet hose in it.

**Note:** Top up the rinsing bucket with more solvent if the inlet filter stops being submerged. Do not allow the rinsing bucket to run dry with the pump still running at any point in the procedure below.

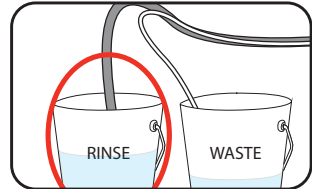

4. Ensure the priming lever is in the 'prime' position then switch the unit on. Check the waste bucket and wait for a constant stream of clear solvent to come out of the return pipe.

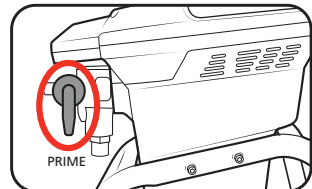

**Note:** The solvent in the rinsing bucket may turn cloudy from excess spray material in the hose. Wait for the solvent coming out of the return pipe to turn the same colour, then switch off the unit, pour the contents of the rinsing bucket into the waste bucket and repeat steps 3 & 4 until the solvent coming out of the return pipe runs clear.

5. Ensure the pressure control dial is set to medium and flip the priming lever to the spray position.

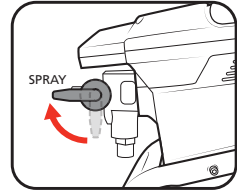
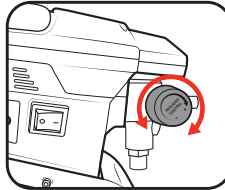

6. Aim the spray gun at the waste bucket, then squeeze and hold the trigger until most of the paint is removed from the high pressure hose.

**Note:** Submerging the tip into the solvent before spraying will help to reduce back spray and splatters.

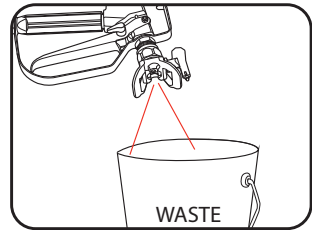

**Note:** If no spray comes out of the spray gun, the tip may have dried and clogged. Switch off the unit and follow the cleaning procedure for the spray tip in the 'CLEANING THE SPRAY GUN' section of this manual.

7. Lock the spray gun trigger and rotate the spray tip by 180°.

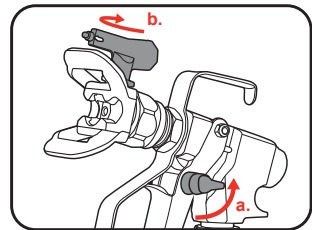

8. Unlock the trigger. Squeeze and hold the trigger to spray solvent through the gun & high pressure hose.

9. Repeat step 8 until only solvent is emitted from the spray gun. Continue topping up the rinsing bucket with solvent as required.



10. Perform the **Pressure Release Procedure**.

11. Disconnect the inlet hose & return pipe from the sprayer, shake out any excess solvent and allow to dry.

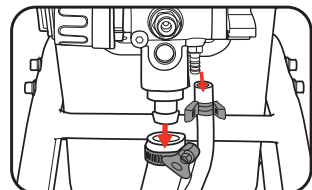



## 5. CLEANING THE SPRAY GUN



**WARNING!** ENSURE THE TOOL IS SWITCHED OFF & DISCONNECTED FROM THE POWER SUPPLY BEFORE PERFORMING ANY OF THE FOLLOWING OPERATIONS.



**WARNING!** ENSURE THAT THE PRESSURE RELEASE PROCEDURE HAS BEEN PERFORMED BEFORE COMMENCING THESE STEPS.

The procedures described below will need to be repeated even if already completed whilst cleaning the pump from the previous section.

1. Disconnect the high pressure hose from the sprayer unit and the spray gun from the high pressure hose by loosening the nut with a 19mm spanner.
2. Place one end of the high pressure hose over the waste bucket. Keep the other end of the hose higher up and begin coiling the hose. This will allow any remaining solvent in the hose to drip out.

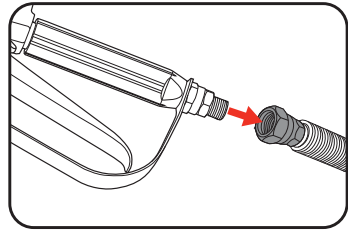

3. Remove the tip guard and spray tip from the spray gun with the 27mm spanner. Rinse these in the solvent to remove any remaining spray material.

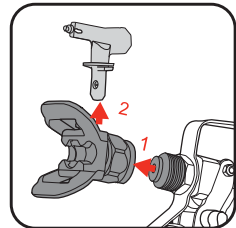
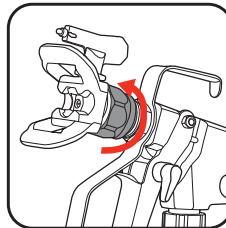

**Note:** There is a small spacer and washer used to locate the spray tip within the tip guard. Be careful not to lose these components when removing the tip guard from the spray gun.

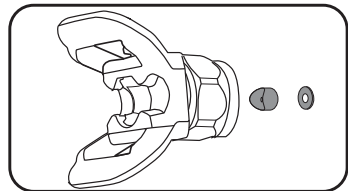

4. Unscrew the nut below the handle using a 19mm spanner and a shifter (not supplied).

**Note:** Using a shifter or bench vice to hold the upper part of the spray gun will make this step much easier.

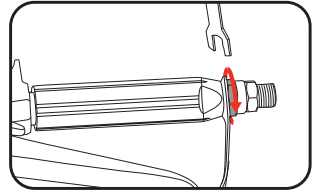

5. Unscrew the handle and remove the mesh filter. Clean all components in the solvent.

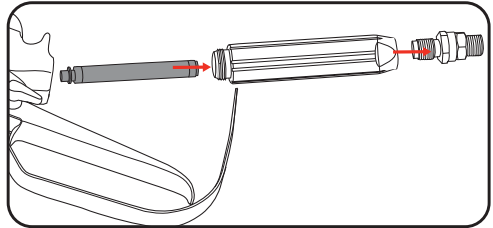

6. To clean the mesh filter, remove the cap at the end of the filter and pull the mesh section off. Use the supplied brush to scrub the inside of the mesh filter.

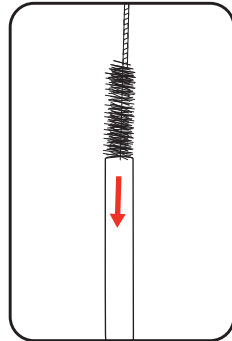
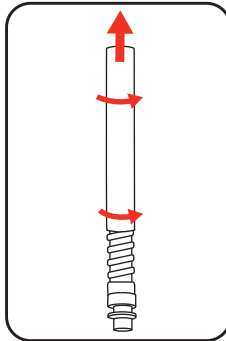
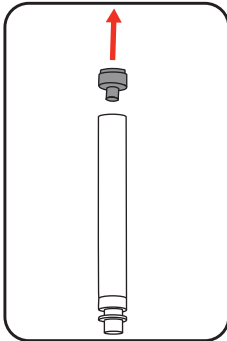

**Note:** After cleaning, inspect the condition of the filter. If the mesh filter is clogged with dried paint, has started fraying, or has deformed out of shape, it will need to be replaced.

7. Wipe down all parts of the spray gun and allow to dry before re-assembling.

# MAINTENANCE

## 6. WORN SPRAY TIPS



**WARNING!** BEFORE CARRYING OUT ANY MAINTENANCE PROCEDURE, MAKE SURE THAT THE TOOL IS DISCONNECTED FROM THE POWER SUPPLY TO PREVENT ACCIDENTAL STARTING.

When a spray tip starts to wear, the orifice gets bigger and rounder reducing the fan pattern size. This can result in less control and more overspray during use.

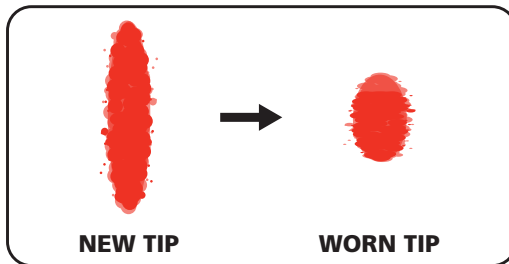

Some signs to look out for include:

- Painting takes longer than usual,
- More paint is consumed than usual,
- The finish is uneven and more runs appear than is usual.

If this issue occurs, do not try to compensate by increasing the spray pressure; this will just waste spray material and increase wear on the pump. Replace the worn tip. Correctly replacing the worn spray tip when necessary can improve the working life of the sprayer.

To help extend the life of spray tips,

- Spray at the lowest pressure that provides an even spray pattern;
- Filter the spray material with a strainer (not supplied) before use;
- Clean the filters after every use;
- Clean the spray tip with the soft-bristled brush.

## 7. SPRAY TIP SELECTION

This product is provided with a **517 spray tip**. Spray tips are numbered such that:

- The first digit, when multiplied by two, gives the spray width in inches,
- The last two digits specify the orifice size in thousandths of an inch (a larger orifice increases paint flow).

When selecting a spray tip, choose one that has an orifice size to suit the spray material and a spray width to suit the surface to be painted. The following are recommended spray tip orifice sizes for various types of spray materials:

| Spray Material         | Orifice Size (Inches) |
|------------------------|-----------------------|
| Lacquers (Water Based) | 0.013 - 0.015         |
| Acrylics (Clear)       |                       |
| Acrylics               |                       |
| Varnishes (low VOC)    |                       |
| Polyurethanes          |                       |
| Stains (Solid)         |                       |
| Enamels (Oil Based)    |                       |
| Latex Paint (Interior) | 0.013 - 0.017         |
| Latex Paint (Exterior) | 0.015 - 0.019         |
| Primers (Latex)        | 0.015 - 0.017         |
| Primers (Oil)          | 0.017 - 0.021         |

**Note:** When changing tip sizes, the spray gun filter size may also need to be changed.

This product is provided with a **medium mesh filter (white) suitable for 0.017 - 0.021 tip sizes**.

Use a fine mesh filter (yellow) for 0.013 - 0.017 tip sizes.

## 8. STORAGE

Once you have completed the cleaning procedure, it is important to protect the internal components of the pump before it is stored away. There should not be any water, water-based material or paint left in the pump, hose, tubes or spray gun prior to storage. Failure to do so may result in premature wear and corrosion of the pump and various other components in your airless paint sprayer. We recommend using a Paint Sprayer specific cleaning lubricant/ anti rust oil or liquid shield available from Bunnings warehouse.



**WARNING!** BEFORE PERFORMING ANY STORAGE MAINTENANCE, ENSURE ALL CLEANING PROCEDURES FOR AIRLESS SPRAYER HAVE BEEN COMPLETED.

**Note:** On first use after storage maintenance, spray initial material into a waste bucket to expel any residue, lubricant/oil or liquid shield.

### Using Liquid Shield

1. Follow the manufacturer's instructions when diluting the liquid shield.
2. Ensure all hoses and the spray gun are assembled on the Airless Paint Sprayer.
3. Perform the procedure for '**Priming The Pump**' and '**Priming The Spray Gun & High Pressure Hose**' described in the Airless Paint Sprayer manual, using the liquid shield solution in place of the spray material.
4. Spray the liquid shield solution into a waste bucket for 5 seconds, then perform the **Pressure Release Procedure**.

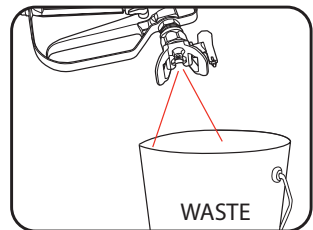

5. Disconnect and drain all hoses into the waste bucket.
6. Wipe the machine with a clean cloth and store in a clean and dry location away from the reach of children.

## Using Oil/Cleaning Lubricants

1. Disassemble the high-pressure hose, return pipe and inlet hose from the unit.
2. Turn the unit over and add some anti rust oil/cleaning lubricant in the inlet hose port.

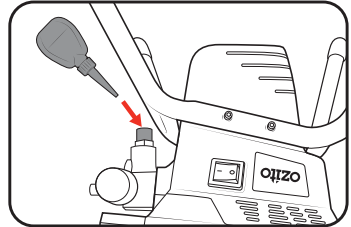

3. Turn the priming lever to the spray position and reduce the pressure setting to low.

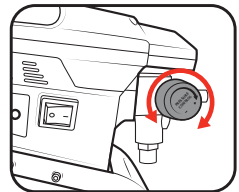
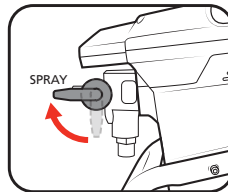

4. Using a thick cloth, block the paint outlet port.



**WARNING!** ENSURE YOUR HANDS/  
BODY PARTS ARE NOT COVERING  
THE OUTLET. MAKE SURE ONLY THE  
RAG IS COVERING THE OUTLET.

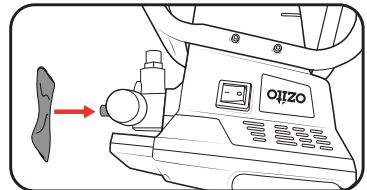

5. Switch the unit on for five seconds to lubricate system and then switch the unit off.

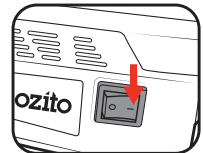

6. Turn the priming lever to the prime position.

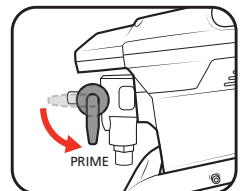

7. Wipe the machine down with a clean cloth and store in a clean and dry location away from the reach of children.

# SPARE PARTS

Should an issue arise with your Airless Paint Sprayer or if you wish to make a claim under the 1 year Replacement Warranty, please call our Customer Service Helpline prior to returning your product.

**Spare parts can be ordered from the Special Orders Desk at your local Bunnings Warehouse.**

**For further information, or any parts not listed here, visit [www.ozito.com.au](http://www.ozito.com.au) or contact Ozito Customer Service:**

**Australia 1800 069 486**

**New Zealand 0508 069 486**

**E-mail: [enquiries@ozito.com.au](mailto:enquiries@ozito.com.au)**

