



Scandia

The power of fire



2026 RANGE & ACCESSORIES BROCHURE

Take this brochure to the special orders desk or order online at [bunnings.com.au](https://www.bunnings.com.au)





Scandia
The power of fire

Inspired stylish design, created here in Australia.

Fire stirs our most primal instincts, brings everyone together and can mesmerise us for hours. It is our original heat source and brings a relaxed, warm ambience to any space. Nothing beats it.

At Scandia, our fires are designed to be sustainable, reliable and are always constructed from only the highest quality materials but most of all they are affordable. We use innovative technology to create each of our clean-burning, efficient fires and are proud to offer Australia's largest range of fireside accessories. Each of our fires is covered by a structural guarantee and supported by our dedicated and experienced customer support team.

Our business was forged in Melbourne in 1948 to meet the needs of our customers for affordable, quality wood fires. Three generations later we remain true to our core philosophy as we continue to create new ranges that offer simplicity, functionality and meet our collective obligation to the environment.

As the temperature drops, gather around with friends and family to make memories that only time spent together in front of a Scandia can create.

Scandia, the power of fire to inspire.

WHY SCANDIA?

70

Experience
With 70 years' experience, we are proud to be at the forefront of design and engineering of wood fires in Australia.



Australian Owned
Scandia is proudly 100% Australian family owned. We have been supplying Australians with quality products and are continuously expanding our range.



Industry Trusted
Our products are proven in thousands of homes and trusted by retailers and installers throughout Australia.



Complete Home Heating Solutions.
We have everything you need when it comes to affordable, sustainable and high quality products. Shop our range of wood fires, wood storage, cleaning and maintenance accessories today!



WOOD FIRED HEATING

SUSTAINABLE AND AFFORDABLE

- 🔥 Wood fired heating is the most sustainable and cost-effective home heating option available.
- 🔥 Environmental impact is a priority! 98% of the hardwood we use is sustainably sourced.
- 🔥 Our wood fired heaters feature two-stage air systems to control emissions effectively.
- 🔥 Explore more about Scandia at www.scandia.com.au





Warmbrite 140. Item no: 3171288

WARMBRITE 140







Perfect for a cottage, holiday house, shed or man cave, the Warmbrite 140 is a compact radiant wood fire that delivers an impressive 15.6kW output to warm spaces up to 140m².

This traditional design comes with high-temperature resistant glass that incorporates the 'Clearview' air wash system and a robust firebrick-lined 5mm firebox that comes with a 10-year warranty.

KEY BENEFITS

-  **Little fire, big impact**
Suitable for smaller areas needing big warmth.
-  **Simplicity at its finest**
Simple sleek design to fit anywhere.
-  **Maximum burn times**
Firebrick lined firebox delivers maximum burn times.

TECHNICAL DETAILS

-  **Heat up to 140m²**
-  **Firebox: 375w x 330d x 350h**
-  **Radiant heating - No fan**
-  **Heater: 500w x 445d x 700h**
-  **5mm heavy duty firebox**
-  **Low emissions**
-  **10 Year firebox warranty**

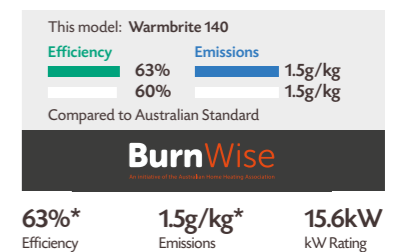

MUST HAVES

FLUE KIT OPTIONS

Sleek Black Flue Kit	3171234
Black Mesh Flue Kit	3180672

ROOF FLASHING OPTIONS

Metal Roof Flashing	3171673
Tile Roof Flashing	3171672

HEARTH OPTIONS : Straight 1050mm x 1200mm or Corner 1245mm x 1245mm

Please note: All wood fires must be installed by a qualified person whose work conforms with local council regulations, Australian/New Zealand standards (AS/NZS 2918:2018) & manufacturers recommendations.

CONSUMABLE ITEMS

Firebrick Set	3171704
Baffle	0280284
Brick Retainer	0280286
Glass Seal	3171537
Rope Seal	3171543

OPTIONAL ACCESSORIES

Complete your set up with one of many Scandia designed fireside accessories combined with our comprehensive range of cleaning and maintenance products.

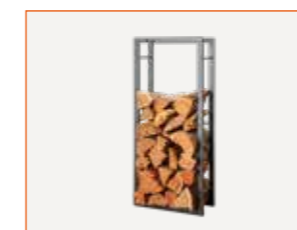

RECTANGULAR 1000
Item No: 3171657



ECOBRIK PAPER BRIQUETTE MAKER
Item No: 0731510

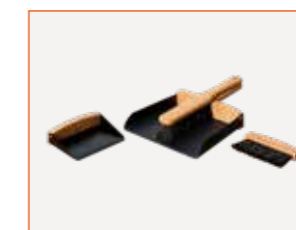

JAPANDI FIRESIDE ASH SET
Item No: 0734464



ECO FAN
Item No: 0411395



- ✓ By adding the Scandia EcoFan, or the new EcoFan Swing, you will be able to gently circulate heat throughout your living space.
- ✓ Like all free-standing wood fires, the Warmbrite 140 needs to sit on an appropriate non-combustible base to protect your floors. Scandia has multiple hearth options in store to suit your requirement - ready for easy installation.
- ✓ You can maintain a healthy wood fire by assuring that your firewood is properly cured for at least 12 months. But if you're not sure, the Scandia Moisture Meter can tell you if your wood is ready to burn. We recommend a moisture content of less than 20%
- ✓ Generates a massive amount of heat for a compact unit, so much so that you can use the top surface for soups, stews, boiling the kettles or even your percolating your favorite Italian coffee.

WARMBRITE 200 REINVENTED



Warmbrite 200 Series 4. Item no: 0405097

WARMBRITE 200

A stylish re-imagining of a traditional, medium-size, fan-forced convection wood fire engineered to effectively heat living spaces up to 200m². Because of its minimum clearance requirements, the Warmbrite 200 is ideal for compact environments where space is limited. The Warmbrite 200 comes equipped with a 3-speed electric fan that allows you to choose just how warm you want to be at any given moment, an 8mm Easyfit baffle plate and will accommodate logs up to 350mm in length to maintain a longer burn through-out the night.

KEY BENEFITS

- ✓ Stylish tradition
Minimum clearances, big heat output.
- ✓ Clearview air wash system
Reduces blackening of glass and cuts down cleaning maintenance.
- ✓ Quality you can trust
6mm heavy-duty steel firebox with a 10 year warranty.

TECHNICAL DETAILS

- 🏠 Heat up to 200m²
- 🌀 Fan-forced convection heating
- 🔥 6mm heavy duty firebox
- 🕒 10 Year firebox warranty
- 📏 Firebox: 500w x 360d x 300h
- ⚙️ Heater: 595w x 505d x 690h
- 🌿 Low emissions

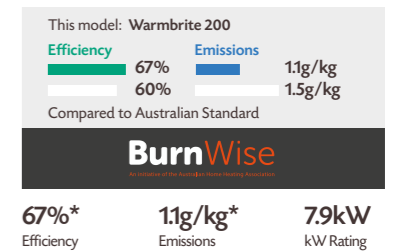

MUST HAVES

FLUE KIT OPTIONS

Sleek Black Flue Kit	3171234
Black Mesh Flue Kit	3180672

ROOF FLASHING OPTIONS

Metal Roof Flashing	3171673
Tile Roof Flashing	3171672

HEARTH OPTIONS : Straight 1050mm x 1200mm or Corner 1425mm x 1425mm

Please note: All wood fires must be installed by a qualified person whose work conforms with local council regulations, Australian/New Zealand standards (AS/NZS 2918:2018) & manufacturers recommendations.

CONSUMABLE ITEMS

Firebrick Set	3171705
Baffle	0280289
Brick Retainer	0280291
Glass Seal	3171537
Rope Seal	3171545

OPTIONAL ACCESSORIES

Complete your set up with one of many Scandia designed fireside accessories combined with our comprehensive range of cleaning and maintenance products.



750 ROUND
Item No: 0743327

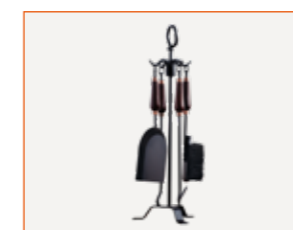

DELUXE FIRETOOL SET
Item No: 3180728

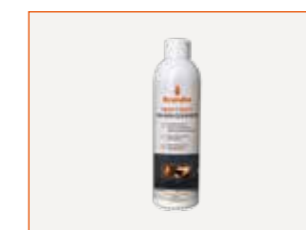

HEAVY DUTY GLASS CLEANER
Item No: 3171625



FIREPLACE GLOVES
Item No: 3171512



- ✓ Scandia's number-one seller for five years in a row!
- ✓ Utilise the smaller shelf on the Scandia 750 Round Wood Storage to store fire starters and matches.
- ✓ The Warmbrite 200 3-speed fan-forced convection wood fire is perfect for heating multiple living spaces, up to 200m².
- ✓ Generally, a fan-forced convection wood fire will have minimal clearance requirements which makes them better suited to small spaces.
- ✓ Keep your wood fire glass crystal clean and damage-free with a regular wipe down using Scandia's specially formulated Heavy Duty Glass Cleaner.

WARMBRITE 300
REINVENTED



Warmbrite 300 Series 4. Item no: 0405096

WARMBRITE 300

The big brother in the Warmbrite range, the Warmbrite 300 is a large and superbly styled convection wood-burning fan-forced convection wood fire, engineered to heat up to 32 squares (300m²).

It's perfect for use in large open-plan homes and commercial spaces such as pubs, clubs and showrooms where ambience is paramount. The Warmbrite 300 also incorporates the 'Clearview' air wash system, which helps prevent blackening of the glass and cuts down on cleaning maintenance.

KEY BENEFITS

- ✓ Effortlessly warm
Warmbrite 300 will effortlessly heat up to 300m²
- ✓ Large firebox
Easily fit logs up to 350mm in length.
- ✓ Fan forced heating
Equipped with a 3-speed electric fan.

TECHNICAL DETAILS

- 🏠 Heat up to 300m²
- 🌀 Fan-forced convection heating
- 🔧 6mm heavy duty firebox
- 🕒 10 Year firebox warranty
- 📏 Firebox: 600w x 400d x 360h
- ⚙️ Heater: 695w x 536d x 733h
- 🍷 Low emissions

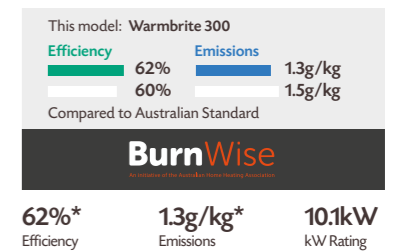

MUST HAVES

FLUE KIT OPTIONS

- Sleek Black Flue Kit 3171234
- Black Mesh Flue Kit 3180672

ROOF FLASHING OPTIONS

- Metal Roof Flashing 3171673
- Tile Roof Flashing 3171672

HEARTH OPTIONS : Straight 1050mm x 1200mm or Corner 1425mm x 1425mm

Please note: All wood fires must be installed by a qualified person whose work conforms with local council regulations, Australian/New Zealand standards (AS/NZS 2918:2018) & manufacturers recommendations.

CONSUMABLE ITEMS

- Firebrick Set 3171706
- Baffle 0280296
- Brick Retainer 0280297
- Glass Seal 3171537
- Rope Seal 3171545

OPTIONAL ACCESSORIES

Complete your set up with one of many Scandia designed fireside accessories combined with our comprehensive range of cleaning and maintenance products.

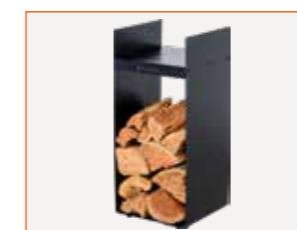

STACKER
Item No: 0547462



NORDIC FLEXIBLE
ASH PAN & BRUSH SET
Item No: 0735492

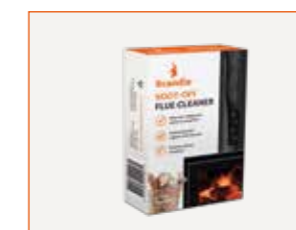

SOOT-OFF FLUE CLEANER
Item No: 0104653



EARTHWEAVE ESSENTIALS
LOG BASKET HEAVY DUTY
RECTANGLE MEDIUM
Item No: 0731513



- ✓ The Scandia Stacker wood storage unit holds enough wood to operate your Warmbrite 300 comfortably over a cold winter's night.
- ✓ This large Fan-forced convection wood fire is perfect for heating up large open spaces or multiple living spaces within a household. The Warmbrite 300 is the home's perfect primary source of heat.
- ✓ When loading perfectly seasoned firewood logs into your firebox, ensure to orientate/lay them front to back. This allows combustion air to flow between the logs which will result in a longer, cleaner and more efficient burn.
- ✓ Reduce the amount of wood fire emissions in the atmosphere by regularly using Scandia Soot-Off, it's an easy-to-use burn sachet. When burnt the safe organic ingredients cleans the glass and the flue system which in turn increases the wood fire's efficiency.



Fraam Horizon. Item no: 0572445



Optional Plinth*. Item no: 0572448



Optional Woodbox*. Item no: 0572450



Concrete plinth - custom set up

*Fraam Horizon not included

FRAAM HORIZON

Introducing the Scandia Fraam Horizon with Pedestal – an Australian designed masterpiece seamlessly marrying inspired, stylish European design with cutting-edge technology. The Fraam Horizon has a distinct style; distinguishing itself through minimalist lines, innovative features such as a 5mm steel outer casing and fold away brushed stainless steel handle. A Large landscape glass door creates an unobstructed ambience sitting on top of an elegant pedestal or optional additions like the Fraam Woodbox or Plinth.

KEY BENEFITS

- ✓ Keeping you warm
3 speed remote controlled fan giving you comfort from anywhere in the room.
- ✓ Vermiculite liners
Giving you a more efficient, cleaner burn, projecting heat into the room.
- ✓ Optional upgrade
Elegant Pedestal included or change it up by purchasing the optional Plinth or Woodbox.

TECHNICAL DETAILS

- 🏠 Heat up to 300m²
- 📺 Large panoramic glass door
- 🕒 10 Year firebox warranty
- 🌀 3 Speed wireless fan control
- 📏 Firebox: 795w x 317d x 328h
- 🔥 Heater: 950w x 505d x 800h
- 📏 5mm heavy duty firebox
- 🌿 Low emissions

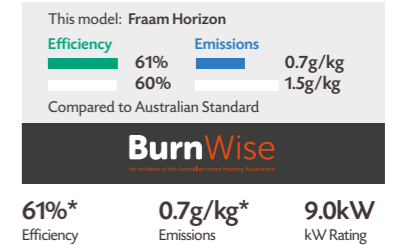

MUST HAVES

FLUE KIT OPTIONS

Sleek Black Flue Kit	3171234
Black Mesh Flue Kit	3180672

ROOF FLASHING OPTIONS

Metal Roof Flashing	3171673
Tile Roof Flashing	3171672

HEARTH OPTIONS : Straight 1200mm x 1200mm

Please note: All wood fires must be installed by a qualified person whose work conforms with local council regulations, Australian/New Zealand standards (AS/NZS 2918:2018) & manufacturers recommendations.

CONSUMABLE ITEMS

Firebrick Set	SG030600041
Baffle x2	SG030700911
Brick Retainer Corner	SPSTY111
Brick Retainer Rear	SPSTY112
Glass Seal	3171537
Rope Seal	3171545

OPTIONAL ACCESSORIES

Complete your set up with one of many Scandia designed fireside accessories combined with our comprehensive range of cleaning and maintenance products.



JINDABYNE SLING
FIREWOOD STORAGE
Item No: 040796

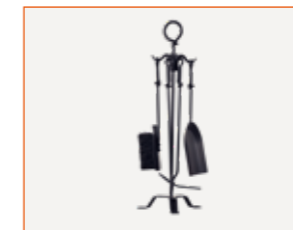

CLASSIC FIRETOOL SET
Item No: 3180727

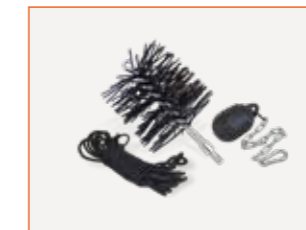

6" PULL THRU FLUE BRUSH KIT
Item No: 3171521



DRY GLASS CLEANER
Item No: 3171521



- ✓ The Fraam Horizon comes with a 3-speed fan, when determining your installation position consider the proximity to a power point.
- ✓ When loading perfectly seasoned firewood logs into your firebox ensure to orientate/lay them front to back. This allows combustion air to flow between the logs which allows a longer, cleaner and more efficient burn.
- ✓ Adjusting the combustion air down for a slow overnight burn may leave soot or creosote build-up on the glass, use Scandia's glass cleaning range to maintain a clean and clear fire view.
- ✓ When opening the large panoramic door, crack the seal and wait for 10 seconds, this allows any excess smoke to be drawn out and up through the flue and not into the living space.



Fraam Sheer with woodbox. Item no: 0572446



Optional Plinth*. Item no: 0572448

Concrete plinth - custom set up

*Fraam Sheer not included

FRAAM SHEER

Introducing the Scandia Fraam Sheer with woodbox – an Australian designed masterpiece seamlessly marrying inspired, stylish European design with cutting-edge technology. The Fraam Sheer, distinguishes itself through innovative features such as a 3-speed fan and sophisticated upright design incorporating an elegant wood box.

KEY BENEFITS

- ✓ **Low emissions**
The Fraam Sheer emits less than HALF of the Australian Standards emissions and 68% efficiency.
- ✓ **Perfect for the minimalist**
Worrying about wood storage is a thing of the past with the Fraam Sheer + Woodbox.
- ✓ **Style it your way**
Multiple base options available for this model or you can create your own custom concrete plinth to make it even more unique.

TECHNICAL DETAILS

- 🏠 **Heat up to 210m²**
- 🔥 **Firebox: 365w x 320d x 500h**
- 🏠 **Contemporary design**
- 🔥 **Heater: 518w x 505d x 1070h**
- 🕒 **10 Year firebox warranty**
- 🔥 **5mm heavy duty firebox**
- 🎛️ **3 Speed wireless fan control**
- 🌿 **Low emissions**

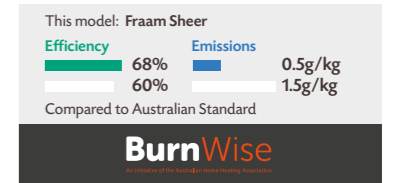

68%* Efficiency 0.5g/kg* Emissions 7.3kW kW Rating

MUST HAVES

FLUE KIT OPTIONS

Sleek Black Flue Kit	3171234
Black Mesh Flue Kit	3180672

ROOF FLASHING OPTIONS

Metal Roof Flashing	3171673
Tile Roof Flashing	3171672

HEARTH OPTIONS : Straight 1050mm x 1200mm or Corner 1245mm x 1245mm

Please note: All wood fires must be installed by a qualified person whose work conforms with local council regulations, Australian/New Zealand standards (AS/NZS 2918:2018) & manufacturers recommendations.

CONSUMABLE ITEMS

Firebrick Set	SG030600040
Baffle	SG030700911
Brick Retainer Corner	SPSTY111
Brick Retainer Rear	SPSTY112
Glass Seal	3171537
Rope Seal	3171545

OPTIONAL ACCESSORIES

Complete your set up with one of many Scandia designed fireside accessories combined with our comprehensive range of cleaning and maintenance products.

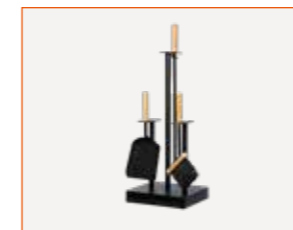

JINDABYNE FIRETOOL SET
Item No: 0407961



CRE-ASSAULT FIREPLACE GLASS
CLEANER SPONGE
Item No: 0411394



MILAN FIRESIDE STORAGE BASALT
Item No: 0407960



MOISTURE METER
Item No: 0743683



- ✓ Enhance your design statement by combining your Fraam Sheer with the sleek and modern Scandia Jindabyne Firetool set, inspired by contemporary European design.
- ✓ The Sheer's wood storage pedestal is ingeniously designed to accommodate ample seasoned firewood, ensuring a sufficient supply for a night's burn.
- ✓ The Fraam Sheer features a three-speed fan that delivers ample heating, suitable for large open-plan living spaces of up to 210m².
- ✓ Typically, fan-forced convection wood fires like the Sheer require minimal clearance, making them ideal for compact, modern living spaces.

THE SMARTER WAY TO HEAT YOUR HOME



EXTERNAL AIR IS IDEAL FOR:

- ✓ Modern, airtight, or passive homes
- ✓ Older homes affected by draughts

Experience the Difference with the Scandia Australis.

DESIGNED FOR MODERN LIVING

The Scandia Australis with optional **External Air** combines design, engineering excellence and environmental responsibility – helping you create a comfortable, efficient home without compromise*.

Why choose External Air?

Modern homes are designed to be airtight and energy-efficient, often incorporating features like double glazing and other passive design principles. That's great for energy savings but it can impact the performance of your traditional wood fire.

How does External Air work?

Traditional wood fires draw air from inside your room. In sealed or well-insulated spaces, this may limit combustion, resulting in inefficient burning. Scandia's External Air system delivers a dedicated supply of oxygen from outside, straight to the firebox – creating an efficient, consistent, cleaner fire regardless of your indoor air quality.

BENEFITS OF EXTERNAL AIR



Reduced Emissions

When your wood fire does not get enough oxygen it will create more smoke, soot and pollutants. With External Air your fire is fed oxygen from outside at the right level for a hotter, even and more complete burn. This results in cleaner burning and therefore lower emissions.



Better Indoor Air Quality

A traditional wood fire draws air from inside the room; this can pull in dust, smoke or cold draughts from cracks, floors and vents. With External Air, you will have no loss of internal oxygen or negative air pressure. Your home will be fresher with fewer draughts.



Improved Efficiency

When wood burns properly, you get improved heat output from each log. This results in burning less wood to heat the same space, saving money and effort.



Stops Draughts

External Air prevents vacuum effects caused by traditional wood fires, with its own dedicated supply of oxygen External Air wood fires do not compete with the air inside your home. This results in consistent, even comfort without cold draughts.



Cleaner Burns

External Air supply gives your fire a steady stream of oxygen, resulting in a more complete burn with less smoke and more flame. Giving you less ash, less smoke and a brighter more attractive fire.

*When installed with Scandia room sealed flue kit



AUSTRALIS

Made in Melbourne this Australian designed collection artfully combines contemporary lines, smooth rounded corners and sleek flat finishes that suit the decor of any Aussie home.

The Australis stands out for its innovative features like the convenient pull-out ash draw, exceptional thermal efficiency, and remarkably low flue emissions. We've also incorporated room seal features allowing for installation in new homes and ensuring compliance under the minimum 7 Star national building standards.

The Australis, born from a dedication to innovation and premium materials, signifies a new era in wood fire heating. The inclusion of cutting-edge engineering ensures efficient heating, making it an environmentally responsible choice. Crafted with precision, Australis embodies simplicity, functionality, and a deep-seated commitment to the Australian environment.

KEY BENEFITS OF THE AUSTRALIS RANGE

✓ **15 year warranty**
We've got your firebox covered for up to 15 years*

✓ **Easy cleaning**
The Australis range is built for convenience, the ash removal ports provide easy cleaning, paired with a lidded pull-out ash draw. Fireplace mess is a thing of the past!

✓ **Unbeatable ambience**
Fitted with a large 500mm+ glass door, the Australis Range creates that perfect woodheater ambience, making your home comfy and snug.



External air supply option
For reduced emissions, better indoor air quality, improved efficiency and cleaner burns. The External air feature makes these units perfect for passive homes or older homes effected by draughts.



3 speed fan with RF remote
Control your fan settings from anywhere the room or via the buttons located on the side.



Vermiculite liners
Projects heat forward, creates a hotter combustion and protects your firebox for longer.



Dual ash ports
Clean your heater with efficiency thanks to the dual ash ports.



Pull-out ash draw with closable lid
Experience easy ash removal from your wood heater.



Stylish design
Flat surfaces, rounded corners and elegant fittings designed to suit any Aussie home.

*Warranty is covered as stated in manual and is subject to warranty criteria.**When installed with room sealed flue kit.



Australis M. Item no: 0577519



Australis L. Item no: 0577520

AUSTRALIS M

TECHNICAL DETAILS

- Heat up to 250m²
- Firebox: 490w x 300d x 323h
- 6mm heavy duty firebox
- Heater: 630w x 468d x 780h
- 15 Year firebox warranty
- Low emissions
- Large Glass Door: 621w x 447h

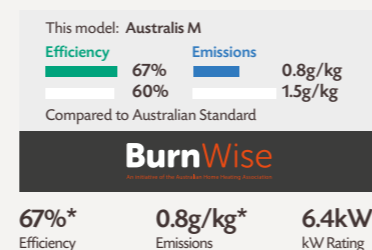

MUST HAVES

FLUE KIT OPTIONS		ROOF FLASHING OPTIONS	
Sleek Black Flue Kit	3171234	Metal Roof Flashing	3171673
Black Mesh Flue Kit	3180672	Tile Roof Flashing	3171672

HEARTH OPTIONS : Straight 1050mm x 1050mm or Corner Corner 1245mm x 1245mm

Please note: All wood fires must be installed by a qualified person whose work conforms with local council regulations, Australian/New Zealand standards (AS/NZS 2918:2018) & manufacturers recommendations.

CONSUMABLE ITEMS

Firebrick Set	SG030600036
Baffle	SG030700767
Brick Retainer Corner	SG030700975
Brick Retainer Rear	SG030700977
Glass Seal	3171537
Rope Seal	3171545

AUSTRALIS L

Order this product at the Special Order Desk or order online at bunnings.com.au

TECHNICAL DETAILS

- Heat up to 350m²
- Firebox: 540w x 325d x 374h
- 6mm heavy duty firebox
- Heater: 694w x 500d x 835h
- 15 Year firebox warranty
- Low emissions
- Large Glass Door: 684w x 503h

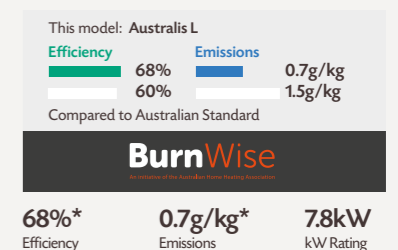

MUST HAVES

FLUE KIT OPTIONS		ROOF FLASHING OPTIONS	
Sleek Black Flue Kit	3171234	Metal Roof Flashing	3171673
Black Mesh Flue Kit	3180672	Tile Roof Flashing	3171672

HEARTH OPTIONS : Straight 1050mm x 1200mm or Corner 1425mm x 1425mm

Please note: All wood fires must be installed by a qualified person whose work conforms with local council regulations, Australian/New Zealand standards (AS/NZS 2918:2018) & manufacturers recommendations.

CONSUMABLE ITEMS

Firebrick Set	SG030600036
Baffle	SG030700767
Brick Retainer Corner	SG030700975
Brick Retainer Rear	SG030700977
Glass Seal	3171537
Rope Seal	3171545



Heat & Cook. Item no: 3170754

HEAT & COOK

Whether it's a wood-fired pizza out on the deck on a sunny day, or the primary source of heat for your small-to-mid-sized home, Scandia's 'Heat & Cook' wood fire and cooking appliance is the perfect off-the-grid solution for heating, cooking and to supplement your solar hot water in winter with the addition of a hot water boiler (optional).

It comes with a large baking oven and a cook top to match. The Heat & Cook has two removable trays and a heat shield that can be removed to take that heat all the way up. Fitted with high temperature resistant glass and incorporates the 'Clearview' air wash system, which helps prevent blackening of the glass and cuts down on cleaning maintenance.

KEY BENEFITS

- ✓ Perfect off-the-grid solution
Heat your home, cook with large baking oven and cooktop, and supplement solar hot water in winter*.
- ✓ Cooktop choices
Removable hotplates means open flame cooking.
- ✓ You're in control
Temperature controlled large baking oven for easy cooking.

TECHNICAL DETAILS

- 🏠 Heat up to 200m²
- 🔥 Radiant heating - no fan
- 📏 5mm heavy duty firebox
- 🕒 10 Year firebox warranty
- 📏 Firebox: 430w x 330d x 380h
- 📏 Heater: 650w x 568d x 826h
- 📏 Oven: 440w x 365d x 300h
- 💧 Optional hot water jacket
- 🎯 Radiant cooking surface
- 👑 Large baker's oven

MUST HAVES

FLUE KIT OPTIONS

Sleek Black Flue Kit	3171234
Black Mesh Flue Kit	3180672

ROOF FLASHING OPTIONS

Metal Roof Flashing	3171673
Tile Roof Flashing	3171672

HEARTH OPTIONS : Straight 1050mm x 1050mm or Corner 1245mm x 1245mm

Please note: All wood fires must be installed by a qualified person whose work conforms with local council regulations, Australian/New Zealand standards (AS/NZS 2918:2018) & manufacturers recommendations.

CONSUMABLE ITEMS

Firebrick Set	0683491
Brick Retainer	0280301
Firebox Liner (Left)	SP50116
Firebox Liner (Right)	SP50115
Firebox Bottom Plate	SP50130
Glass Seal	3171537
Rope Seal	3171543

OPTIONAL ACCESSORIES

Complete your set up with one of many Scandia designed fireside accessories combined with our comprehensive range of cleaning and maintenance products.



HOT WATER JACKET
Item No: 3170899

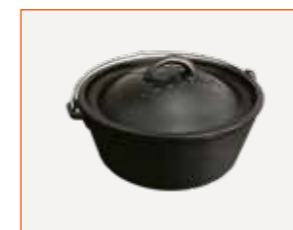

CAMP OVEN
Item No: 3171611



SOOT-OFF FLUE CLEANER
Item No: 0104653



ECO SWING FAN
Item No: 0411397



- ✓ The Heat & Cook is the perfect wood fire for regional locations. Popular with customers wanting a cooking or off-the-grid option.
- ✓ To get the best stove top cooking results from your Heat & Cook, don't use everyday kitchen pots or pans, instead use camping style heavy, well-seasoned cast iron pots and pans.
- ✓ To keep your Heat & Cook in optimum condition, use the supplied heavy duty wire cleaning brush prior to winter to remove any internal built up of soot and creosote.
- ✓ The Heat & Cook is the only wood fire that supports a Hot Water Jacket so you can hook it up to a vented hot water system. (see manual for further details as it cannot be connected to mains pressure water)
- ✓ The Heat & Cook uses liners in the firebox to radiate heat more effectively, some flex and bend in these are normal and only require replacement when 1mm of material is left.

*optional hot water jacket available to order at the special orders desk using item no: 3170899



Edge 50. Item no: 3171487



* Optional wood stacker pedestal not included. Item no: 0367724

EDGE 50

With a nod to French provincial designs and inspired by the idea of bringing your indoor and outdoor living areas together, the Scandia Edge 50's clean lines, elegant legs and three-sided viewing glass are a welcome addition to any living space.

Sophisticated and sleek, the Edge 50 will suit any modern look you're going for while emitting a powerful amount of heat for its size.

KEY BENEFITS

- ✓ **Stunning from any angle**
Three-sided viewing glass creates dreamy ambience from any point in the room.
- ✓ **Evolving design**
Change from the default French provincial leg stand to a modern asymmetrical wood stacker base.
- ✓ **Small and mighty**
Great little space saver that packs a mighty punch, radiantly heating up 200m²

TECHNICAL DETAILS

- 🏠 **Heat up to 200m²**
- 🔥 **Radiant heating - no fan**
- 📏 **5mm heavy duty firebox**
- 🏠 **Optional wood stacker pedestal**
- 🕒 **10 Year firebox warranty**
- 📏 **Firebox: 482w x 334d x 312h**
- 📏 **Heater: 625w x 494d x 814h**
- 🌿 **Low emissions**
- 👁️ **Panoramic fire views with glass on three sides**

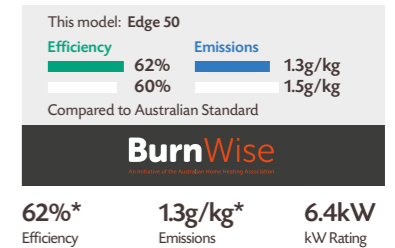

MUST HAVES

FLUE KIT OPTIONS

Sleek Black Flue Kit	3171234
Black Mesh Flue Kit	3180672

ROOF FLASHING OPTIONS

Metal Roof Flashing	3171673
Tile Roof Flashing	3171672

CONSUMABLE ITEMS

Firebrick Set	0280316
Glass Seal	3171537
Rope Seal	3171543

HEARTH OPTIONS : Straight 1050mm x 1050mm or Corner 1425mm x 1425mm

Please note: All wood fires must be installed by a qualified person whose work conforms with local council regulations, Australian/New Zealand standards (AS/NZS 2918:2018) & manufacturers recommendations.

OPTIONAL ACCESSORIES

Complete your set up with one of many Scandia designed fireside accessories combined with our comprehensive range of cleaning and maintenance products.



1838 FIRESIDE LARGE OVAL PAIL
Item No: 0546214

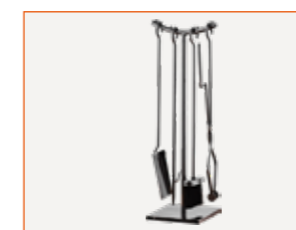

GUN METAL FIRETOOL SET
Item No: 3171608



SCANDI STAND UP FIRESIDE ASH PAN AND BRUSH SET BLACK
Item No: 0734461



ECO FAN
Item No: 0411395



- ✓ By adding the Scandia EcoFan, or the new EcoFan-Swing to the top of your Edge 50, you will be able to gently circulate heat throughout your living space.
- ✓ Use the firebox size to determine the best-cut firewood length. The optimal log length for the Edge 50 is 350mm.
- ✓ The impact-resistant glass front and sides will get hot, so Scandia Heater Guards are always a good safety option when operating this wood fire.
- ✓ The Edge 50 is a compact yet powerful wood fire for its size, careful consideration should be taken with installation and clearances to combustibles please refer to www.scandiastoves.com.au for more information.





Supremacy 200. Item no: 3171219

SUPREMACY 200









This premium mid-size, slow-combustion wood fire is the perfect solution for homes up to 25.8 squares (240m²).

With its bay window design and heavy-duty 8mm steel firebox, the Supremacy 200 is engineered to deliver a unique combination of elegance, technology, sustainability and industry-leading performance.

KEY BENEFITS

-  **Built to last**
15 year firebox warranty
-  **Supreme heating**
Sleek lines and bay window design makes the Supremacy 200 the centrepiece of any room.
-  **Heavy-duty elegance**
Built with an 8mm steel firebox and a unique bay window design.

TECHNICAL DETAILS

-  **Heat up to 240m²**
-  **Firebox: 500w x 410d x 320h**
-  **Fan-forced convection heating**
-  **Heater: 656w x 566d x 720h**
-  **15 Year firebox warranty**
-  **8mm heavy duty firebox**
-  **Soft-touch Infrared remote control fan**
-  **Low emissions**

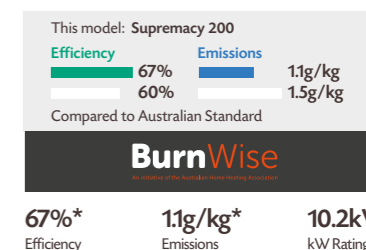

MUST HAVES

FLUE KIT OPTIONS

Sleek Black Flue Kit	3171234
Black Mesh Flue Kit	3180672

ROOF FLASHING OPTIONS

Metal Roof Flashing	3171673
Tile Roof Flashing	3171672

HEARTH OPTIONS : Straight 1050mm x 1050mm or Corner 1425mm x 1425mm

Please note: All wood fires must be installed by a qualified person whose work conforms with local council regulations, Australian/New Zealand standards (AS/NZS 2918:2018) & manufacturers recommendations.

CONSUMABLE ITEMS

Firebrick Set	0280305
Baffle	0280289
Brick Retainer	0280291
Glass Seal	3171537
Rope Seal	3171543

OPTIONAL ACCESSORIES

Complete your set up with one of many Scandia designed fireside accessories combined with our comprehensive range of cleaning and maintenance products.



SMALL CHILD SAFETY GUARD
Item No: 0407966

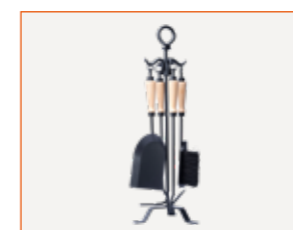

NORDIC ASH FIRE TOOL SET
Item No: 0347837

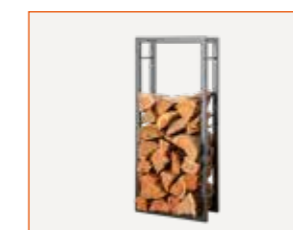

RECTANGULAR 1000
Item No: 3171657



FIREPLACE GLOVES
Item No: 3171512



- ✓ The Supremacy range comes with the "Easyfit" 8mm heavy-duty baffle plate, which has been designed to reflect heat back into the living space. Before the start of winter check your baffle plate, if there are signs of wear and tear it's simple to order and replace.
- ✓ Create a design statement and pair your Supremacy wood fire with the modern design-inspired Jindabyne Sling wood storage accessory and the Jindabyne Firetool set.
- ✓ Supremacy 200 is a Fan-forced convection wood fire with a 3-speed fan. This allows you to regulate the heat within the living space the wood fire is located.
- ✓ When opening the bay window, crack the seal and wait for 10 seconds allowing excess smoke to be drawn out and up through the flue.



Supremacy 300. Item no: 3171224

SUPREMACY 300

The largest model in our premium range, the Supremacy 300 sets an imposing presence in any room.

With its sleek lines, bay window design and massive firebox for larger logs, this powerful yet elegant unit is capable of heating large open plan homes and commercial spaces up to 350m².

KEY BENEFITS

- ✓ **Control in comfort**
Conveniently adjust the heat output with a soft-touch infrared fan remote control from the comfort of your couch.
- ✓ **Industry-leading performance**
69% efficiency, 0.9g/kg on emissions.
- ✓ **Largest in the range**
Capable of heating large open plan homes up to 350m².

TECHNICAL DETAILS

- 🏠 **Heat up to 350m²**
- 🌀 **Fan-forced convection heating**
- 🕒 **15 Year firebox warranty**
- 🔧 **Soft-touch Infrared remote control fan**
- 📏 **Firebox: 597w x 470d x 351h**
- ⚙️ **Heater: 756w x 668d x 762h**
- 🔩 **8mm heavy duty firebox**
- 🌿 **Low emissions**

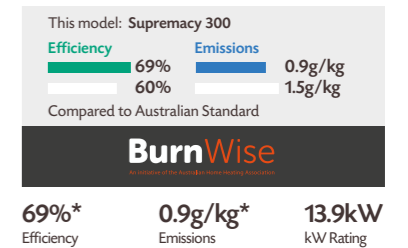

MUST HAVES

FLUE KIT OPTIONS

Sleek Black Flue Kit	3171234
Black Mesh Flue Kit	3180672

ROOF FLASHING OPTIONS

Metal Roof Flashing	3171673
Tile Roof Flashing	3171672

HEARTH OPTIONS : Straight 1050mm x 1200mm or Corner 1425mm x 1425mm

Please note: All wood fires must be installed by a qualified person whose work conforms with local council regulations, Australian/New Zealand standards (AS/NZS 2918:2018) & manufacturers recommendations.

CONSUMABLE ITEMS

Firebrick Set	0280310
Baffle	0280296
Firebrick Retainer	0280297
Glass Seal	3171537
Rope Seal	3171543

OPTIONAL ACCESSORIES

Complete your set up with one of many Scandia designed fireside accessories combined with our comprehensive range of cleaning and maintenance products.

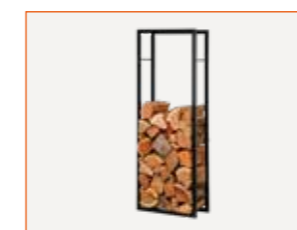

RECTANGULAR 1500
Item No: 0547461

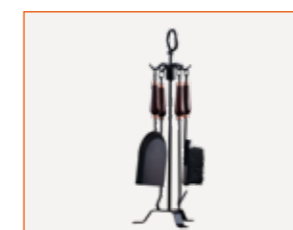

DELUXE FIRETOOL SET
Item No: 3180728

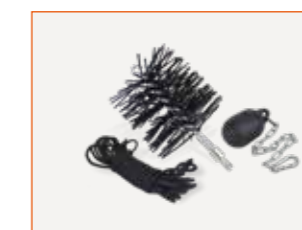

6" PULL THRU FLU BRUSH KIT
Item No: 3171521



MOISTURE METER
Item No: 0743683



- ✓ The Supremacy 300 fan-forced convection wood fire can heat up to 350m², perfect for your primary source of heat in large open-plan living spaces or where multiple-room heating is required.
- ✓ The 8mm heavy-duty steel provides a 15-year firebox warranty.
- ✓ Add an aesthetic style to your living area by storing your firewood close to your Supremacy wood fire. Pair your wood fire with

- Scandia's Rectangular 1500 wood storage system and enjoy your own clean and styled heated living area.
- ✓ Regularly removing dust, dirt and soot using Scandia's spray-on glass and surface cleaner preserves that brand-new wood fire appearance.

Warmbrite 280i. Item no: 0249054



Floor Fascia (included)

WARMBRITE 280i

The Warmbrite 280i combines contemporary styling and excellent performance in a mid-sized, in-built wood fire that is perfect for heating indoor areas up to 280m². The compact design is set off with a large door window that provides a wonderful view of the flames inside, and for the mid wall mount and floor mount options.

KEY BENEFITS

- ✓ Deceptively large
Large firebox lined with refractory firebricks on the back, sides and base to capture and retain heat.
- ✓ Multiple mounting solutions
Existing masonry fireplaces or as an optional 'mid' or 'floor' mount*.
- ✓ Contemporary appeal
Sleek design complements both traditional and modern interiors.

TECHNICAL DETAILS

- 🏠 Heat up to 280m²
- 🏠 To suit mid or floor mount install
- 🔧 Zero clearance option
- 🕒 10 Year firebox warranty
- 📏 Firebox: 600w x 365d x 374h
- 📏 Heater: 672w x 491d x 592h
- 🌿 Low emissions
- 📏 6mm heavy duty firebox

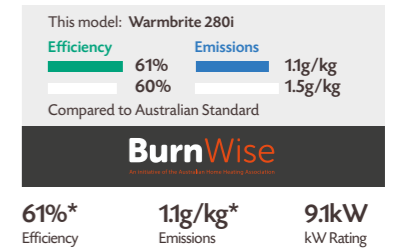

MUST HAVES

INBUILT MASONRY CAVITY INSTALL		ROOF FLASHING OPTIONS	
6" 4M Inbuilt Flue Kit	3170671	Metal Roof Flashing	3171673
		Tile Roof Flashing	3171672
INBUILT TIMBER STUD CAVITY INSTALL			
Zero Clearance Box	0299189		
Triple Skin Zero Clearance Flue Kit	3171271		

CONSUMABLE ITEMS

Firebrick Set	SG030600024
Baffle	SG030700263
Firebrick Retainer	SG030700269
Glass Seal	3171537
Rope Seal	3171544

HEARTH OPTIONS : Custom Straight : 1050w x 550d x 30h

Please note: All wood fires must be installed by a qualified person whose work conforms with local council regulations, Australian/New Zealand standards (AS/NZS 2918:2018) & manufacturers recommendations.

OPTIONAL ACCESSORIES

Complete your set up with one of many Scandia designed fireside accessories combined with our comprehensive range of cleaning and maintenance products.



MATT BLACK INBUILT HEARTH
Item No: 0466292



1837 FIRESIDE OVAL PAIL
Item No: 0546217

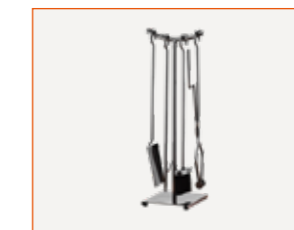

GUN METAL FIRETOOL SET
Item No: 3171608



WOOL BLEND FIRESIDE RUG
Item No: 0244546



- ✓ The appliance comes with a fascia kit for mid-wall or floor mount. For mid-wall mount, install the fascia strip to hide the cavity cutout (not required for floor mount)
- ✓ The Warmbrite 280i combines the best of previous models with a deeper, wider glass panel for visibility, strong heat output, and low emissions—an excellent upgrade from an old open fireplace, helping reduce heating bills
- ✓ The 280i is the perfect inbuilt option for wall cavity and masonry fireplace installations. Contact your installer for advice when installing around combustible materials, for installation compliance you must always use the Scandia Zero Clearance Box and Triple Skin Zero Clearance Flue Kit.
- ✓ Installers need to double-check all installation requirements. If unsure, call for tech help on 1300 HEATER.

ELECTRIC FIRES

Available in-store now items are displayed as ■
 Customer Special Order items are displayed as ■



AURORA 74"
 Item no: 0411393 ■

Overall size:
 1880w x 150d x 429h



AURORA 50"
 Item no: 0411392 ■

Overall size:
 1270w x 150d x 429h



AURORA 36"
 Item no: 0411396 ■

Overall size:
 915w x 150d x 410h

AURORA

The Scandia Aurora reimagines the electric fireplace, bringing a striking visual centerpiece to any space with the touch of a button.

Designed for those who value both aesthetics and versatility, the Aurora offers a fully customisable experience with multiple flame effects, top light, and media lighting colour combinations to suit any mood or style.

Whether you're after a soft glow or a bold statement, the Aurora delivers a captivating display that goes beyond the ordinary. With its sleek design and seamless integration options, it's the perfect way to elevate your living space.

KEY BENEFITS

- ✓ We've got you covered
 All Aurora electric fireplace come with a 2 Year domestic warranty.
- ✓ The perfect fit
 The Aurora is available in 36", 50" and 74" models and can be fitted as a recess option or directly mounted onto a wall.
- ✓ Fully programmable
 Choose your flame, top light and media lighting colour combinations via remote, smart phone app or touch screen controls.

FEATURES

- ✓ Wi-Fi app control
- ✓ Google and Alexa smart home integration
- ✓ Recessed or wall mounting options
- ✓ Available in 3 sizes (36", 50" and 74")
- ✓ LCD slimline remote control
- ✓ Cool touch glass
- ✓ 2 Heat settings (750W and 1500W)
- ✓ 13 Flame and fuel bed colour options
- ✓ Flame effect mode with or without heating mode
- ✓ 4 Downlight colour options (off, Orange, Blue and Purple)
- ✓ Safety overheat protection
- ✓ 1-9 hours timer function
- ✓ All LED lighting technology
- ✓ LCD screen

Multiple flame colour options



Multiple media colour options



Control options



FREESTANDING WOOD FIRE INSTALLATION ACCESSORIES

Promotional items are displayed as ■
Customer Special Order items are displayed as ■



Black Mesh Flue Kit. Item no: 3180672

BLACK MESH 4M FLUE KIT

Designed and tested to suit all Scandia freestanding wood fires, the powder coated, black mesh decorative flue looks great on any of the traditional wood fire range.

ADDITIONAL BLACK MESH PARTS:

Black mesh 1m extension:
Item no: 3170782

Black mesh internal bend kit:
Rear bend kit. Item no: 3170798
Right bend kit. Item no: 3170795 ■
Left bend kit. Item no: 3170794 ■
Front bend kit - Item: 3170796 ■



Sleek Black Flue Kit. Item no: 3171234

SLEEK BLACK 4M FLUE KIT

Designed and tested to suit all Scandia freestanding wood fires, the powder coated, sleek black decorative flue looks great on both of the contemporary and traditional wood fire range.

ADDITIONAL SLEEK BLACK PARTS:

Sleek black 1m extension:
Item no: 3171268

Sleek black internal bend kit:
Rear bend kit. Item no: 3171253
Right bend kit. Item no: 3171251 ■
Left bend kit. Item no: 3171250 ■
Front bend kit - Item: 3171252 ■

WHAT'S INCLUDED IN THE SCANDIA 4M FLUE KIT?

- 4 x 6" 1m 304 SST Active Flue
- 1 x 1m 8" Decorative Casing
- 1 x 1m 8" Decorative Casing with heat shield
- 1m Triple Skin Drop Box - Powder coated
- 1 x 1m 8" Galvanised Casing
- 1 x 1m 10" Galvanised Casing
- SST Anti down draft Cowl & Cone
- 4 Ceramic Spacers
- Ceiling collar
- 2 x Mounting brackets



For more information about flues, scan the QR code to watch a short video or visit our website www.scandiastoves.com.au.

FREESTANDING WOOD FIRE INSTALLATION ACCESSORIES

Promotional items are displayed as ■
Customer Special Order items are displayed as ■



1m External Flue Extension.
Item no: 3170783

EXTERNAL FLUE EXTENSION - 1M

This triple skin kit is perfect for extending both our zero clearance and decorative flue kits in ceiling cavities, walls and above the roof lines in 1m increments.

ADDITIONAL PARTS:

45° External bend kit.
Item no: 3170799



8-10" Penetration Box.
Item no: 3170790 ■

8 - 10" PENETRATION BOX

The 8 - 10" Powder Coated Galvanised Penetration Box is ideal for use where through the floor penetration is required and it is the intent to use decorative mesh, sleek black flue on the second storey.

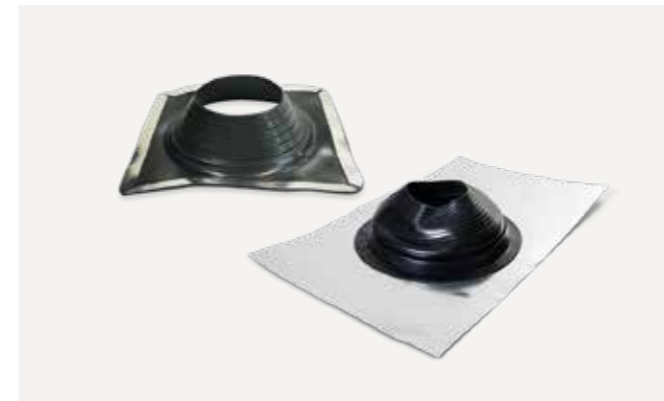

Roof flashing

ROOF FLASHING

Every roof penetration requires a roof flashing to be installed. Scandia's roof flashing range has been engineered for use with high temperature outlets such as flues and chimneys and is pre-cut to fit our standard flue kits.

Available options:

Tile roof flashing. Item no: 3171672
Iron roof flashing. Item no: 3171673

ADDITIONAL INSTALLATION ITEMS

Items not in stock can be ordered from the Special Orders desk – ask in store or visit the website for details.



INSTALLATION

It is a requirement that all Scandia solid fuel appliances are fitted by a qualified, licensed installer whose work complies with local council regulations, Australian standards and manufacturer's specifications. Failure to correctly install is extremely dangerous, will void any warranty claims and may compromise any future insurance claims.

WOOD FIRE FLUE INSTALLATION

SCANDIA 4M FLUE KIT - WHAT'S INCLUDED?

- 4 x 6" 1m 304 SST Active flue
- 1 x 1m 8" Decorative Casing
- 1 x 1m 8" Decorative Casing with heat shield
- 1m Triple Skin Drop Box - Powder-coated
- 1 x 1m 8" Galvanised Casing
- 1 x 1m 10" Galvanised Casing
- SST Anti down draft Cowl & Cone
- 4 Ceramic Spacers
- Ceiling collar
- 2 x Mounting brackets



STANDARD FREESTANDING WOOD FIRE INSTALLATION

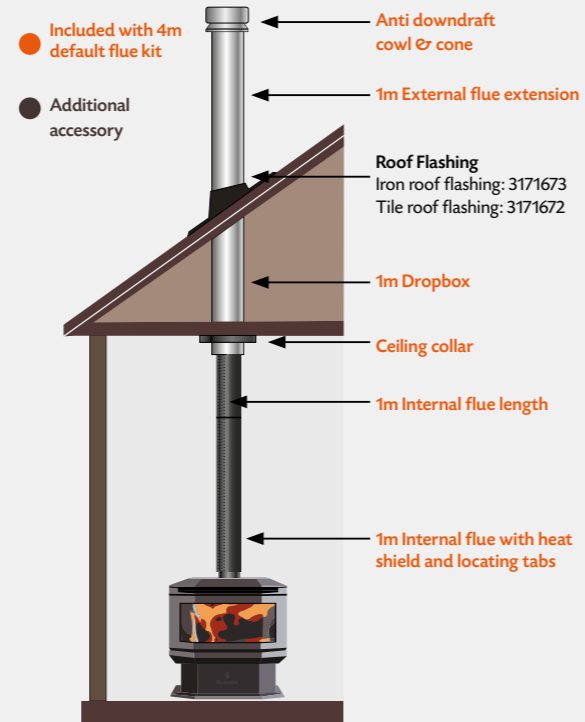

ARE ALL FLUE KITS THE SAME?

Not all flues are equal and an incorrectly installed or poor quality flue can significantly impact the performance of any wood heater. Scandia wood fire appliances are independently tested for emissions, efficiency and thermal clearances using the relevant Scandia flue kit. To ensure you get the best possible performance, we recommend all Scandia wood fire appliances be installed using the recommended Scandia Default Flue Kit and any required extensions.

FLEXI FLUE EXTENSION

The Scandia 6" Stainless Flexi Flue is ideal for use in difficult shaped situations such as you might find in a masonry chimney. Flexi flue can only be ordered in increments of 1 metre up to a maximum length of 5 metres.



Flexi flue extension. Item no: 3170791

NOTE: Always refer to the installation manual on our website for up to date specific detail on the appliance you are installing.

EXISTING MASONRY FIREPLACE INSTALLATION

● Included with 6" inbuilt 4m flue kit

● Additional accessory

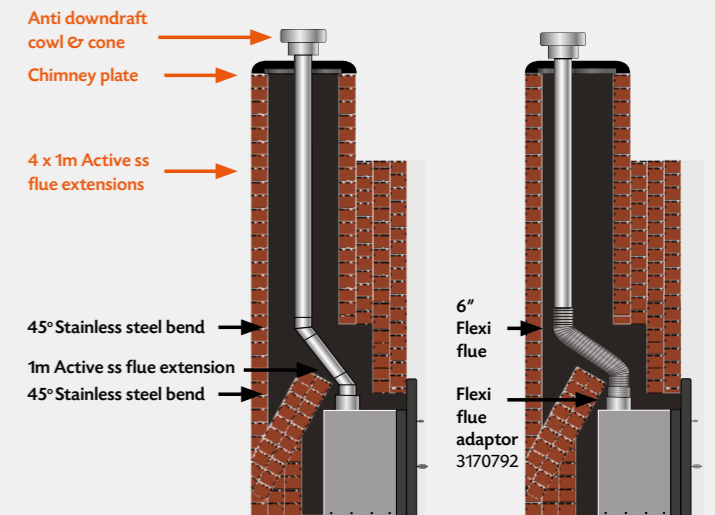

SECOND STORY INSTALLATION THROUGH SIDE WALL

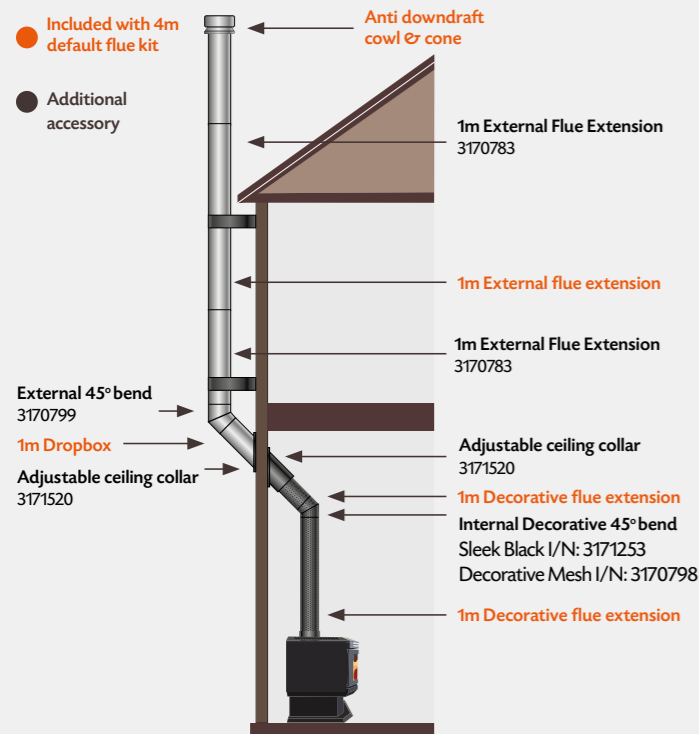

MULTI-STORY WOOD FIRE INSTALLATION

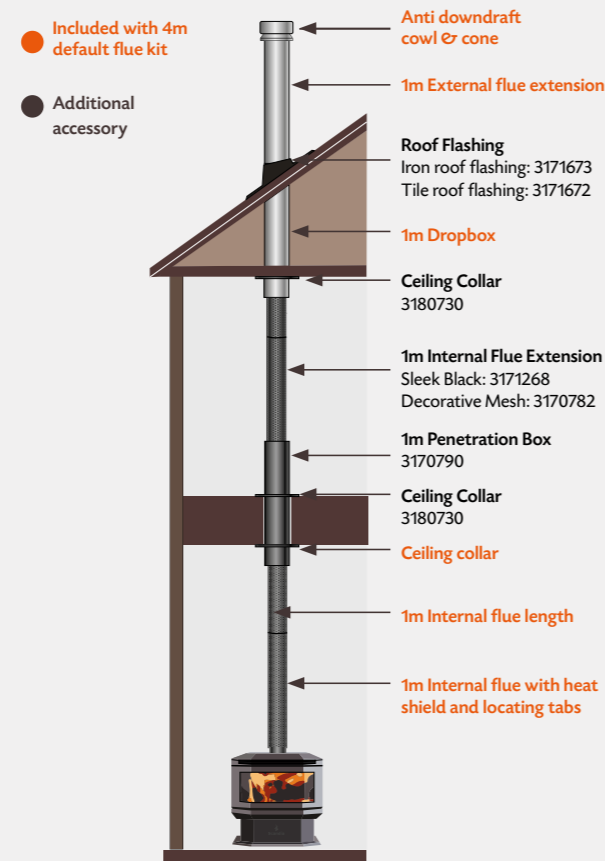

Scandia's inbuilt wood fire flue kit.

CONTENTS

- 4 x 6" (152mm) stainless steel flue 1 metre length.
- 1 x 6" (152mm) stainless steel anti down draft cowl.
- 1 x 6" - 10" (152mm - 254mm) stainless steel cover cone.
- 1 x 10" (254mm) chimney plate.

FEATURES

- 304 SST cowl & cone
- Zinc plated casings
- High temperature powder coat finishes
- Chimney cover plate

PURPOSE

Suitable for installing Warmbrite 280i Insert wood fires in masonry fireplace.

Additional flue lengths or components may be required.

NOTE: Always refer to the installation manual on our website for up to date specific detail on the appliance you are installing.

ZERO CLEARANCE INBUILT WOOD FIRE INSTALLATION

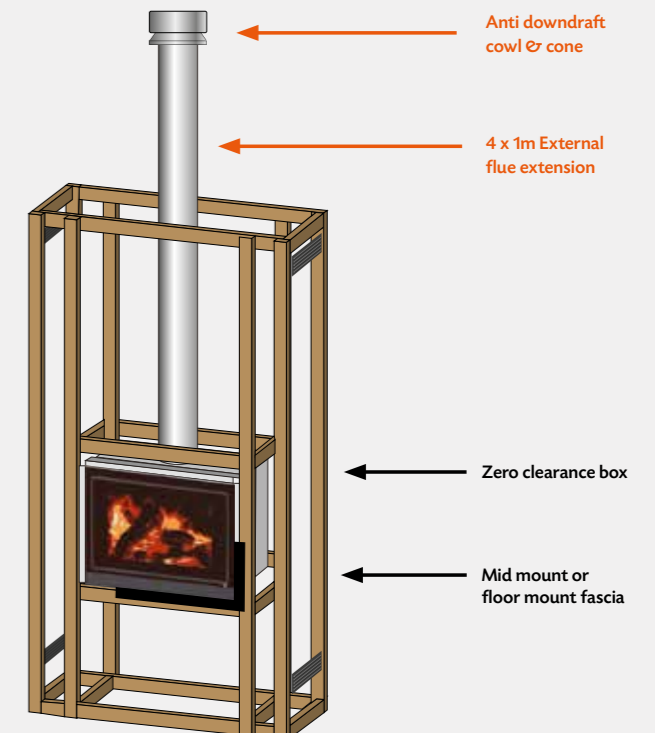

INBUILT INSTALLATION ACCESSORIES

FLEXI FLUE EXTENSION

The Scandia 6" Stainless Flexi Flue is ideal for use in difficult shaped situations such as you might find in a masonry chimney. Flexi flue can only be ordered in increments of 1 metre up to a maximum length of 5 metres.

ADDITIONAL PARTS:

Flexi flue adaptor:
Item no: 3170792
(Required to adapt 6" flexi flue to standard 6" flue.)



Flexi Flue Extension. Item no: 3170791 ■

6" INBUILT 4M FLUE KIT

Designed and tested to suit Scandia inbuilt wood fires, this flue kit is for use in an existing masonry chimney. Kit includes four 1m active flue extensions, chimney plate cover, cowl and cone.

Suits products 3171223, 3171221, 3171534, 3171533, 3172801



6" Inbuilt 4m Flue Kit. Item no: 3170671 ■

ZERO CLEARANCE BOX

When installed with the zero clearance solution, Scandia inbuilt wood fires can be installed into a timber stud wall, making them the ideal solution for contemporary homes that don't have an existing chimney or fireplace.

ZERO CLEARANCE BOX OPTIONS:

Warmbrite 280i:
Item no: 0299189



Zero Clearance Box. Item no: 0299189 ■

WARMBRITE ZERO CLEARANCE FLUE KIT

Designed and tested to accompany the zero clearance box, this flue kit allows the inbuilt wood fire range to be installed into a timber stud wall. Kit includes four triple skin 1m flue extensions, cowl and cone.

Suits products 3171258, 0249054, 3171221, 3171534, 3171533



Zero Clearance Flue Kit. Item no: 3171271 ■

Promotional items are displayed as ■
Customer Special Order items are displayed as ■



HEARTHHS

Promotional items are displayed as ■
Customer Special Order items are displayed as ■



Item no: 3171526

CERAMIC TILE HEARTH - CORNER INSTALL

This modern, black, ceramic tile hearth pad is made from durable, non-combustible materials, is easy to install and available in two sizes; suitable for all wood fire brands.

- Steel angle frame on all sides
- Available in two sizes (mm):
1250 x 1250 Item no: 3171526
1425 x 1425 Item no: 3171527 ■



Item no: 3171524

CERAMIC TILE HEARTH - STRAIGHT WALL

This modern, black, ceramic tile hearth pad is made from durable, non-combustible materials, is easy to install and available in three sizes; suitable for all wood fire brands.

- Steel angle frame on all sides
- Available in three sizes (mm):
1050 x 1050 Item no: 3171524
1050 x 1200 Item no: 3171522
1200 x 1200 Item no: 3171525 ■

CUSTOM HEARTH

Of course, you can always opt for a custom solution to floor protection and, if so, we'd recommend that you speak to a stone mason regarding tiles, concrete and other non-combustible hard surfaces.

TECHNICAL INFORMATION

PROFESSIONAL INSTALLATION

It is a requirement that all Scandia wood fire appliances are fitted by a qualified, licensed installer whose work complies with local council regulations, Australian standards and manufacturer's specifications. Failure to correctly install is extremely dangerous, will void any warranty claims and may compromise any future insurance claims.

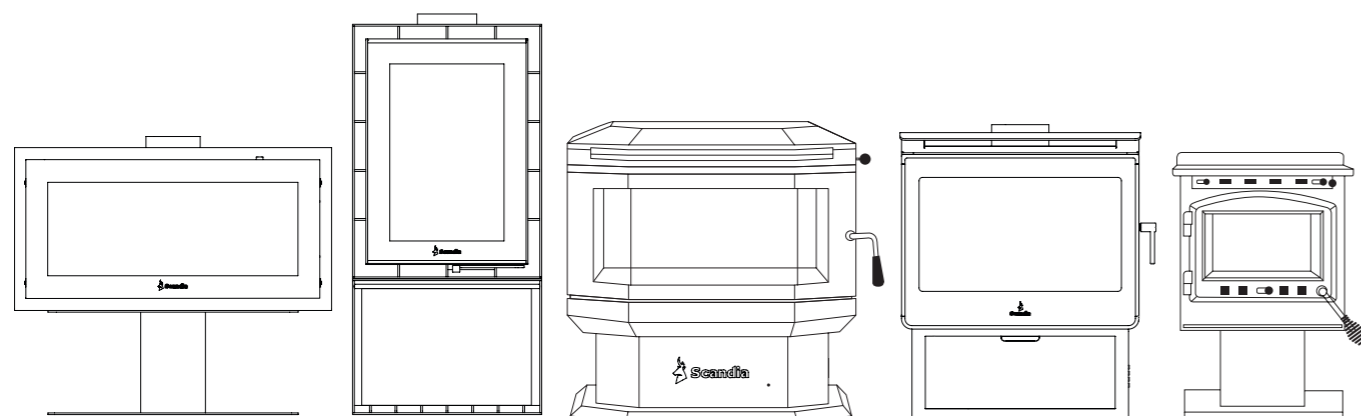

WOODFIRE COMPARISON CHART

	Firebox thickness	3 speed fan	Heating capacity	Emissions	Efficiency	Average kW Rating	Peak kW Rating	Firebox Warranty
FRAAM HORIZON	5mm	Yes	300m ²	0.7g/kg	61%	9.0kW	15.2kW	10 Years
FRAAM SHEER	5mm	Yes	210m ²	0.5g/kg	68%	7.3kW	13.4kW	10 Years
WARMBRITE 140	5mm	No	140m ²	1.5g/kg	63%	15.6kW	18kW	10 Years
WARMBRITE 200	6mm	Yes	200m ²	1.1g/kg	67%	7.9kW	12.1kW	10 Years
WARMBRITE 300	6mm	Yes	300m ²	1.3g/kg	62%	10.1kW	14.4kW	10 Years
WARMBRITE 280i	6mm	Yes	280m ²	1.1g/kg	61%	9.1kW	12.8kW	10 Years
AUSTRALIS M	6mm	Yes	250m ²	0.8g/kg	67%	6.4kW	10.5kW	15 Years
AUSTRALIS L	6mm	Yes	350m ²	0.7g/kg	68%	7.8kW	14.6kW	15 Years
HEAT & COOK	5mm	No	200m ²	N/A	N/A	N/A	N/A - No fan	10 Years
SUPREMACY 200	8mm	Yes	240m ²	1.1g/kg	67%	10.2kW	14.2kW	15 Years
SUPREMACY 300	8mm	Yes	350m ²	0.9g/kg	69%	13.9kW	18.2kW	15 Years
EDGE 50	5mm	No	200m ²	1.3g/kg	62%	6.4kW	9.4kW	10 Years

WOOD FIRE DIMENSIONS AND INSTALLATION CLEARANCES

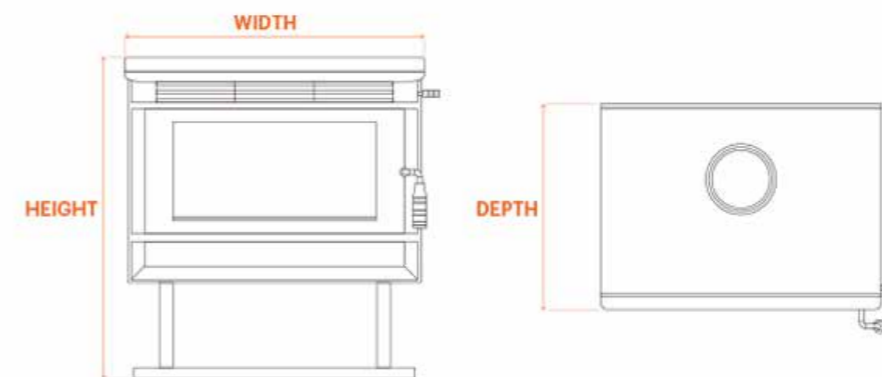

UNIT DIMENSIONS (MM)

	WIDTH	HEIGHT	DEPTH	WEIGHT
FRAAM HORIZON	950	800	505	208kg
FRAAM SHEER	518	1070	505	183kg
WARMBRITE 140	500	700	455	85 kg
WARMBRITE 200	595	690	505	125 kg
WARMBRITE 300	695	733	536	125 kg
AUSTRALIS M	630	780	468	132kg
AUSTRALIS L	694	835	500	156kg
HEAT & COOK	650	826	568	229 kg
SUPREMACY 200	656	720	566	186 kg
SUPREMACY 300	756	762	668	226 kg
EDGE 50	625	814	494	98kg

INTERNAL FIREBOX (MM)

	WIDTH	DEPTH	HEIGHT
FRAAM HORIZON	795	317	328
FRAAM SHEER	365	320	500
WARMBRITE 140	375	330	350
WARMBRITE 200	500	360	300
WARMBRITE 300	600	400	360
AUSTRALIS M	490	300	323
AUSTRALIS L	540	325	374
HEAT & COOK	430	333	380
OVEN SIZE (mm)	440	365	300
SUPREMACY 200	500	410	320
SUPREMACY 300	597	470	351
EDGE 50	482 (MAX)	334 (MAX)	312

FREESTANDING INSTALLATION CLEARANCES

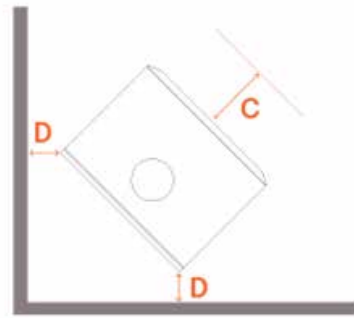
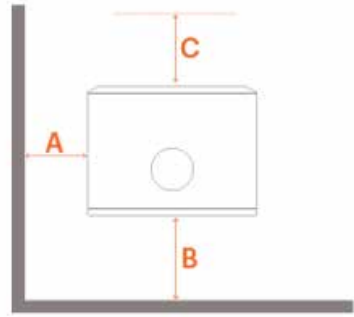

	A	B	C	D
FRAAM HORIZON	550	300	600	N/A
FRAAM SHEER	500	150	300	350
WARMBRITE 140	625	275	350	385
WARMBRITE 200	475	125 [^]	450	225
WARMBRITE 300	500	125 [^]	500	300
AUSTRALIS M	450	125	450	150
AUSTRALIS L	475	150	550	200
HEAT & COOK	400	170	255	200
SUPREMACY 200	350	150	255	75
SUPREMACY 300	400	250	255	75
EDGE 50	650	150	300	350

[^] When using the Scandia Sleek black / Graphite flue fitted with an additional heat shield. Refer to the installation manual on our website for up to date / specific detail on the wood fire you are installing.

INBUILT WOOD FIRE DIMENSIONS

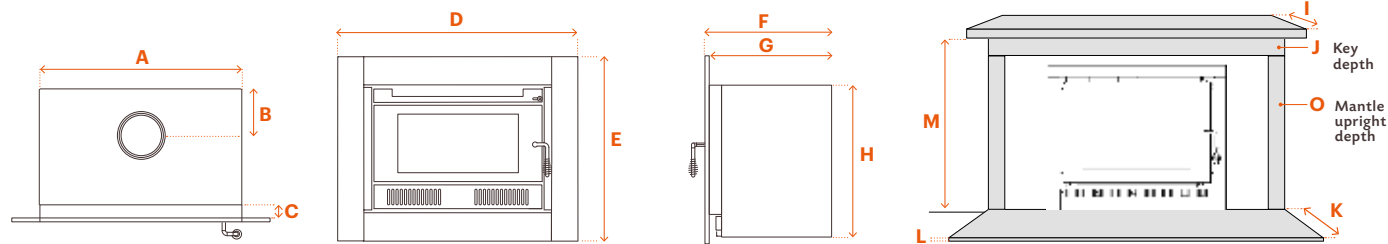

*firebox including front support brackets, excluding decorative fascia

	UNIT SIZE (mm)								
	A	B	C	D	E	F	G	H	FLUE Ø
WARMBRITE 280i	672	167	70	829	649	493	478	592	152

CLEARANCE TO COMBUSTIBLES (mm) FOR SCANDIA INBUILT WOOD FIRES

	CLEARANCES TO COMBUSTIBLE SURFACES (mm)						INTERNAL FIREBOX (mm)		
	I	J	K	L	M	O	HEIGHT	WIDTH	DEPTH
WARMBRITE 280i	250	45	550	25	1225	45	374	600	365

For specifications relating to installation requirements and zero clearance installations please refer to owner's manual. Brochure should be used as a guide only.

ALWAYS USE A QUALIFIED INSTALLER FOR YOUR SCANDIA WOOD HEATER.

Ensuring safety, efficiency, and compliance with local regulations, a qualified installer guarantees your wood heater is fitted correctly, allowing you to enjoy worry-free warmth.

SCAN HERE TO FIND YOUR LOCAL EXPERT!

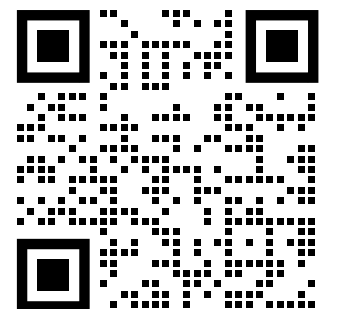

The Australian Home Heating Association

- ✓ Experts you can trust
- ✓ Local certified professionals
- ✓ Safe & compliant installation

@thesaltbushinn

WOOD STORAGE AND FIRETOOL SETS

Scandia's fireside accessories have been designed with the same ethos we use in the development of our wood fires; make them affordable, appealing, robust and practical.

When it comes to wood storage, Scandia provides some excellent choices for both indoor and outdoor use with stylish options to suit all environments, strong enough to hold plenty of Australian hardwood so that you've always got well seasoned firewood at-the-ready.

Scandia Firetool Sets are both practical and stylish, and will make the perfect compliment to any wood storage selection you make from within our range.

Pictured here is the Jindabyne Firetool Set and the Jindabyne Sling Wood Storage, both sold separately.



WOOD STORAGE

Promotional items are displayed as ■
Customer Special Order items are displayed as ■



Scandia wood storage and firetools are available throughout Bunnings stores as seasonal promotional items.



Jindabyne Sling firewood storage. Item: 0407966 ■



750 Round. Item: 0743327 ■

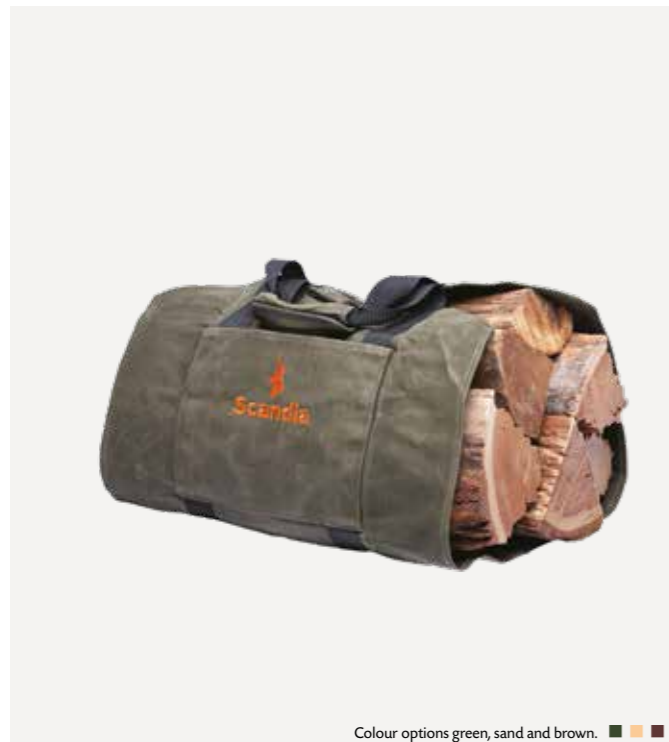

Colour options green, sand and brown. ■ ■ ■

Ironbark Sling Wood Caddy. Item: 0411399 ■



Curved Cantilever. Item: 0547459 ■

WOOD STORAGE

Promotional items are displayed as ■
Customer Special Order items are displayed as ■



1838 Fireside Large Oval Pail. Item: 0546214 ■



1837 Fireside Oval Pail. Item: 0546217 ■

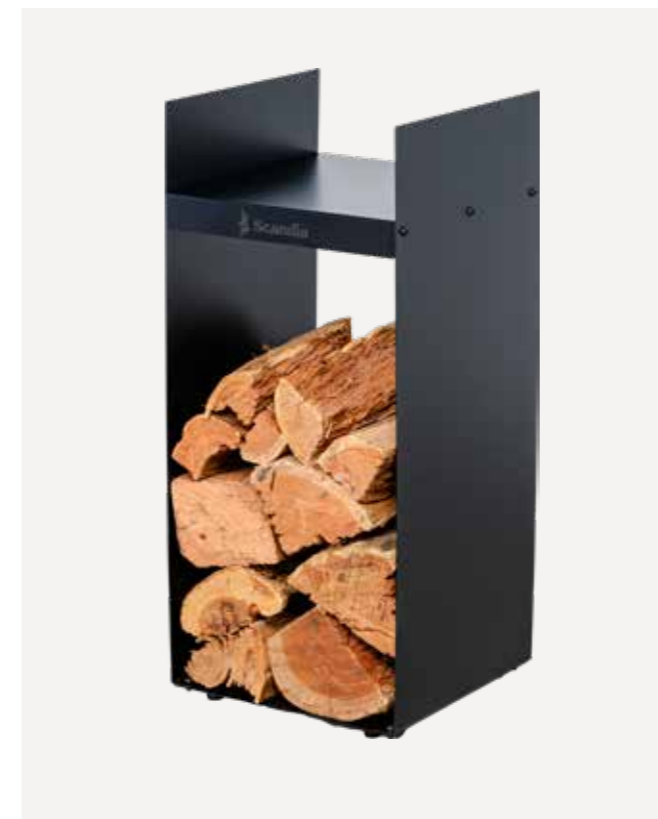

Stacker. Item: 0547462 ■

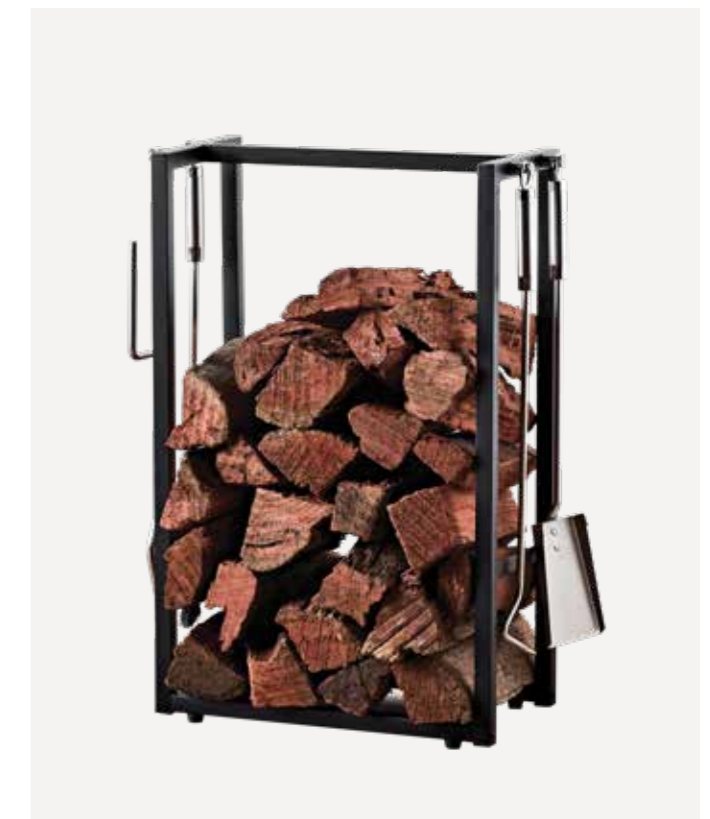

Alpine Firetool Set And Wood Storage. Item: 3171609 ■

WOOD STORAGE

Promotional items are displayed as ■
Available in-store now items are displayed as ■



Rectangular 1500. Item: 0547461 ■

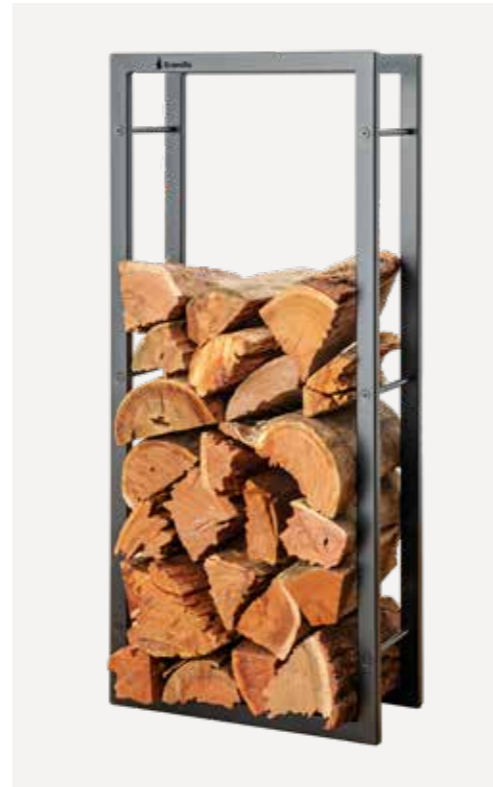

Rectangular 1000. Item: 3171657 ■



EarthWeave Essentials Heavy Duty Rectangle Log Basket. Large: 0731515 ■



EarthWeave Essentials Heavy Duty Rectangle Log Basket. Medium: 0731513 ■

WOOD STORAGE

Promotional items are displayed as ■
Available in-store now items are displayed as ■



Vienna Curve Wood Storage. Item: 0964038 ■



Atelier 450 Wood Storage. Item: 0964044 ■



Milan Fireside Storage. Basalt item: 0407960 Fawn item: 0964039 ■

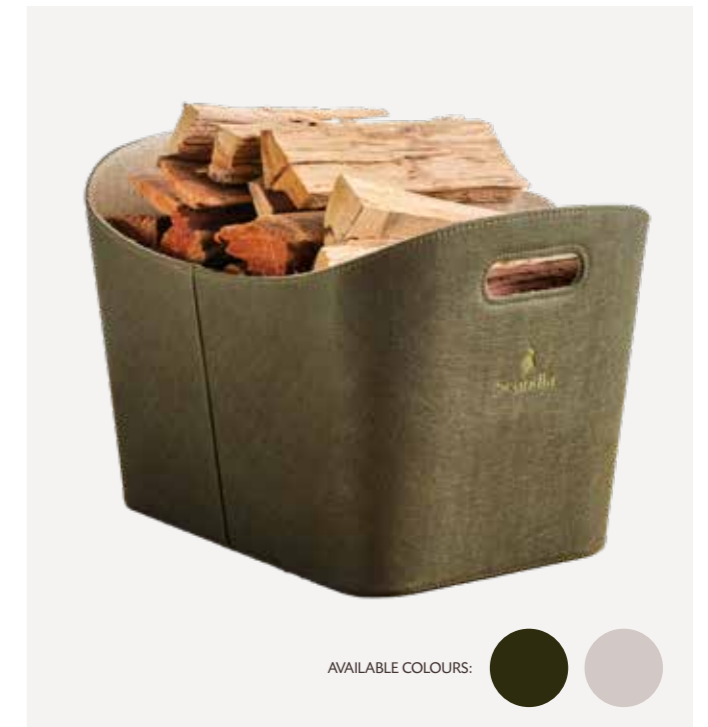

Milan Felt Fireside Storage. Moss item: 0964041. Paperbark item: 0964043 ■

FIRETOOL RANGE

Promotional items are displayed as ■
Available in-store now items are displayed as ■

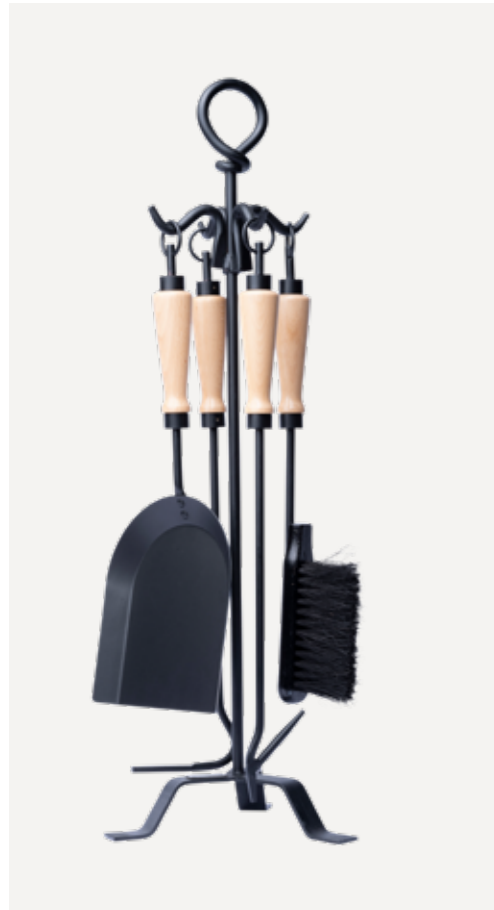

Nordic Ash Fire Tool Set Item: 0347837 ■

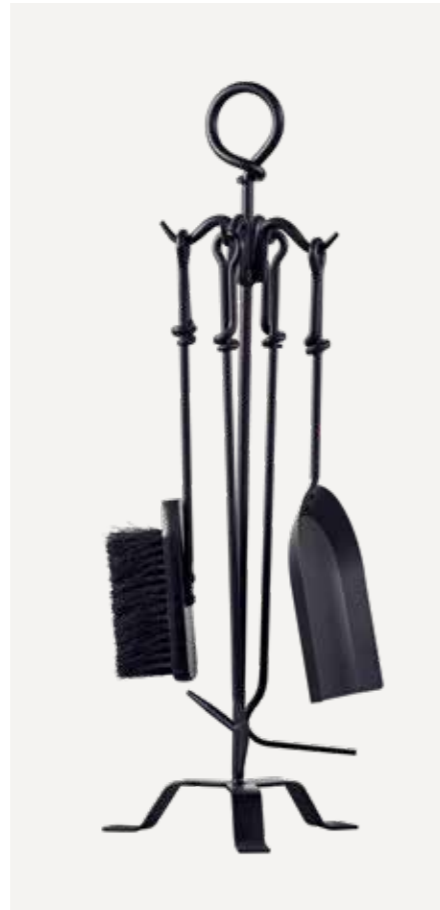

Classic Firetool Set. Item: 3180727 ■

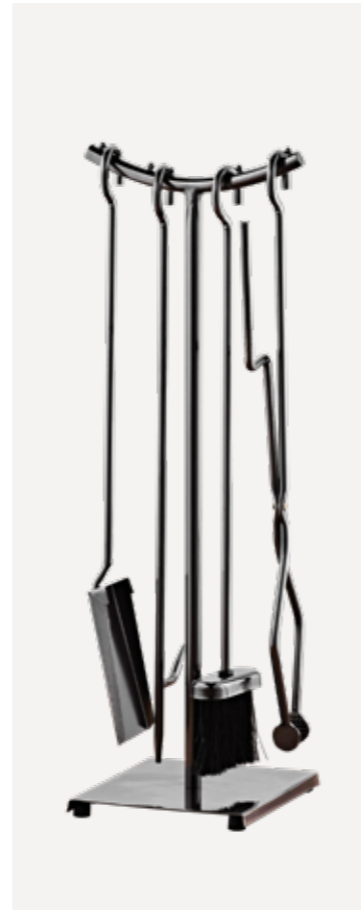

Gun Metal firetool set. Item: 3171608 ■



Jindabyne Firetool Set. Item: 0407961 ■

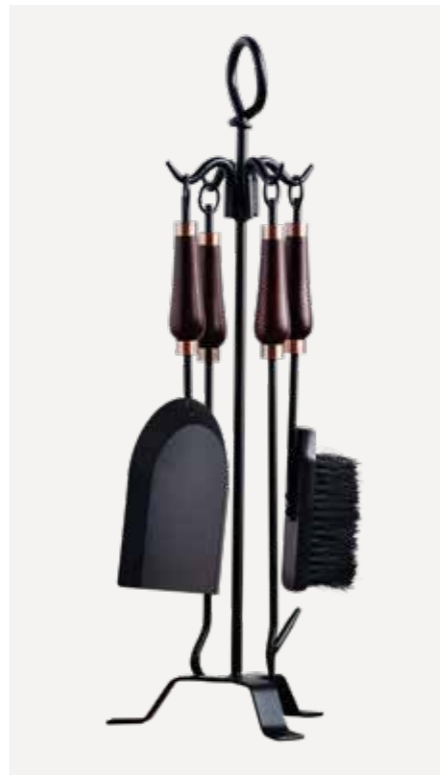

Deluxe Firetool Set. Item: 3180728 ■

HEATER GUARDS

Promotional items are displayed as ■
Customer Special Order items are displayed as ■



Item no: 3180726

SMALL SAFETY GUARD

This sturdy safety guard minimises the risk of coming into contact with what can be extremely hot surfaces. Suits most small to mid size wood fires.

- Heavy duty steel construction
- Dual opening door (685w x 600h)
- Rear stabilising bar
- Size: 1080w x 1055d x 800h



Item no: 3180725

LARGE SAFETY GUARD

This sturdy safety guard will minimise the risk of coming into contact with what can be extremely hot surfaces. Suits most large wood fires.

- Heavy duty steel construction
- Dual opening door (860w x 600h)
- Rear stabilising bar
- Size: 1275w x 1275d x 800h



Item no: 3171519

LARGE CORNER SAFETY GUARD

This sturdy safety guard will minimise the risk of coming into contact with what can be extremely hot surfaces. Designed to accommodate corner installations for most large wood fires.

- Heavy duty steel construction
- Dual opening door (860w x 600h)
- Rear wall secure points
- Size: 2050w x 720d x 800h

CLEANING SOLUTIONS AND ACCESSORIES

Scandia's cleaning solutions and accessories are designed with the same philosophy that drives our wood heaters—making them affordable, effective, and built to last.

Our range is tough on soot and grime but easy to use, ensuring your wood heater stays as inviting as the warmth it provides. Pictured here is the Nordic Flexible Ash Pan & Brush Set available in two stylish colours to suit any home!



CLEANING

Promotional items are displayed as ■
Available in-store now items are displayed as ■



Nordic Flexible Ash Pan and Brush Set. Item: 0735492 ■



Japandi Fireside Ash Set. Item: 0734464 ■



Scandi Fireside Ash Pan and Brush Set. Black Item: 0734465 ■
Lite Grey Item: 0964045 ■ Sage Green item: 0964040 ■

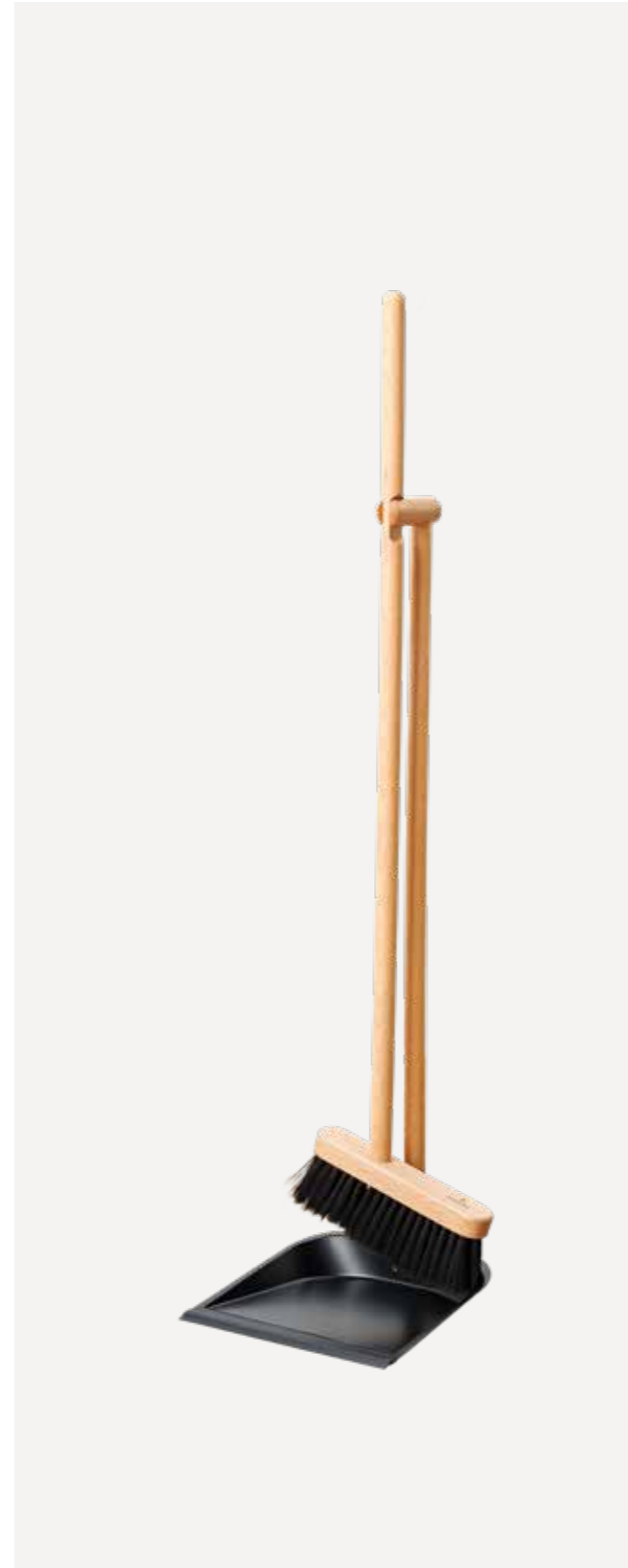

Scandi Stand Up Fireside Ash Pan and Brush Set. Item: 0734461 ■

ACCESSORIES

Promotional items are displayed as ■
Available in-store now items are displayed as ■



EcoBrick Paper Briquette Maker Item: 0731510 ■

ECOBRIK PAPER BRIQUETTE MAKER

Transform Paper Waste into Eco-Friendly Fuel!

The Paper Briquette Maker lets you turn old newspapers, cardboard, and paper scraps into compact, burnable briquettes for fireplaces, wood stoves, and fire pits. This simple, sustainable tool helps reduce waste while saving on heating costs. Just soak, press, dry and enjoy cozy warmth with a greener, budget-friendly alternative.

ACCESSORIES

Promotional items are displayed as ■
Available in-store now items are displayed as ■



Item no: 0411397 ■

ECO FAN SWING

With no power input required, the Eco Fan Swing runs on the heat generated from our radiant wood fires and oscillates at a 46-degree angle to gently and evenly disperse the warm air around the room.



Item no: 0411395 ■

ECO FAN

The thermo-powered Eco Fan can be positioned on the top panel of any radiant wood fire for the thermally powered motor to gently circulate warm air around any room.



Item no: 3171512 ■

FIREPLACE GLOVES

Heavy-duty, flame-resistant gloves protect your hands from heat when replenishing wood or tending your fire.



Item no: 0244546 ■

WOOL BLEND FIRESIDE RUG

Protect your floors from scuff, ash or stray embers with our wool blend fireproof rug.

- Wool blend fireproof hearth rug
- Protects floors & coverings from stray embers
- 1115mm wide x 570mm deep x 25mm thick



Item no: 0743683 ■

MOISTURE METER

An essential tool for measuring the readiness of seasoned firewood and building materials, the Moisture Meter assures a better, cleaner fire.

- 9 Wood density grades
- Portable & easy to use
- Battery included
- Dual-mode moisture detection

CLEANING

Promotional items are displayed as ■
Available in-store now items are displayed as ■

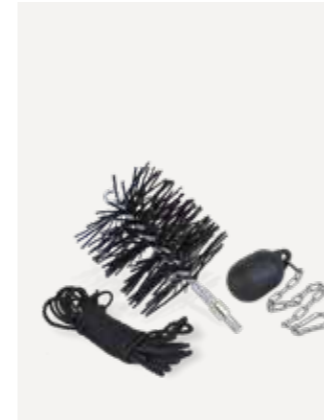

Item no: 3171521 ■

6" PULL THRU FLUE BRUSH KIT

Simply attach the snap-lock weighted ball and chain and brush to each end of the rope provided for a pull-thru flue cleaning solution.

- Weighted ball and chain
- 10m rope extension
- Snaplock connectors
- Heavy-duty poly brush

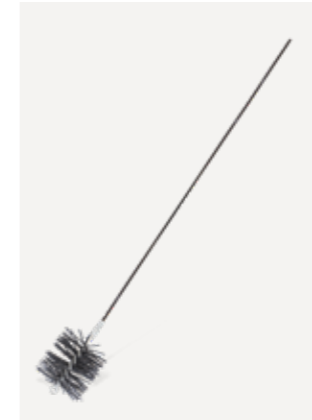

Item no: 3180729 ■

6" EXTENDABLE FLUE BRUSH

Clean your flue safely from ground level up to 5m with the Scandia flexible flue brush kit. Pull-through and rooftop cleaning options are also supported.

- Five 1m flexible extensions
- Threaded metal connectors
- Pull-through option fitted



ADDITIONAL ITEMS

Parts or accessories for installation or maintenance are available from Bunnings stores. Items not in stock can be ordered from the Bunnings Special Orders desk, including:

- Rope seals
- Cleaning products
- Firebricks
- Gasket adhesive & sealant
- Firebrick Cement



Item no: 3171514 ■

DRY GLASS CLEANER

Easily removes burnt soot and creosote. Suitable for wood fires or stove glass and ceramic cooktops without the need for liquid or cleaning agents.

- No rinsing required
- Non-scratch
- Stainless steel
- 2 pads per packet



Item no: 0104653 ■

SOOT-OFF FLUE CLEANER

For stainless steel flues, brick and masonry chimneys, our industrial-grade organic Soot-Off makes cleaning your chimney or flue quick and easy. Results in reduced smoke, cleaner glass and higher efficiency.

- Easy-use, simply burn sachet in the wood fire
- Industrial grade organic soot remover
- 3 x 50g Sachets per pack



Item no: 0411394 ■

CRE-ASSAULT FIREPLACE GLASS SUPER SPONGE

Wood fire glass cleaner made from sustainable and biodegradable 40mm high-density cellulose wood fibre material.

- Dry application
- Machine washable
- Non-scratch
- 1 sponge per packet



Item no: 3171529 ■

SCANDIA HIGH TEMP METALLIC BLACK PAINT

The perfect spray to retouch any scratches and knocks to your wood fire, flue or BBQ.

- Perfect colour match for your Scandia wood fire
- Sprays evenly
- 60-minute full dry application
- Can be heat cured for even longer-lasting results

I'VE MOVED:
FIND ME IN THE
PAINT SECTION!

FIREBRICKS AND FIREBOX LINERS

Customer Special Order items are displayed as



FIREBRICK – REPLACEMENT SETS

Scandia has replacement sets for your new or classic Scandia stove or wood fire. It's good to check your firebricks regularly and if a firebrick is cracked or damaged it is recommended that it be replaced or repaired before it quickly deteriorates.

- Heat reflective vermiculite firebrick sets.
- Suitable for most wood fires.



Firebricks are a vital component of your wood fire, reflecting the heat of the fire to contain the warmth within the wood fire so that it can circulate in a controlled manner.

Designed to withstand extreme temperatures, they protect the steel sides of the wood fire from excess temperatures, meaning they will be more durable with improved longevity.

Scandia's heat-reflective vermiculite firebricks have low thermal conductivity, meaning the heat is not conducted through the brick but rather reflected back into the firebox making it hotter and more efficient. Firebricks also protect the outer shell of the wood fire from direct contact with the heat source.

Some units also come with refractory firebricks which store the heat, not reflect it.

With constant exposure to extreme temperatures, the bricks will degrade gradually. Signs of degradation include large cracks and breakdown of the bricks which is a good indication that they are due for replacement.

Easy to replace, they are often held in with a retainer and then just positioned into place. So, it's important to inspect and maintain your firebricks at least once a season as they are a consumable that will require maintenance over time.

Scandia has a full range of firebrick sets as well as replacement sets for your new or vintage Scandia wood fire.

FIREBRICK REPLACEMENT SETS

Item no.	Description	Size (mm)	Qty
3171510	1" Split firebrick	230 x 115 x 25mm	10
3171704	WB 140 firebrick set	230 x 120 x 36mm	8
	(Contains 3 sizes)	230 x 120 x 38mm notch	1
		183 x 162 x 25mm	4
3171705	WB 200 firebrick set	200 x 98 x 28mm	9
	(Contains 3 sizes)	200 x 90 x 28mm	2
		218 x 144 x 25mm	4
3171706	WB 300 firebrick set	200 x 108 x 28mm	11
	(Contains 3 sizes)	200 x 55 x 28mm	2
		269 x 116 x 25mm	6



FAQ

WHAT ARE THE ADVANTAGES OF WOOD FIRE HEATING?

Other than the obvious soothing warmth that a wood fire provides, heating with wood is both sustainable and economical. Wood is a renewable non-fossil fuel, and with the current Australian Standard being one of the strictest in the world, the impact of a wood fire on the environment is significantly lower than that of other heat sources.

WHAT KINDS OF RUNNING COSTS DO I NEED TO CONSIDER?

The Australian Home Heating Association (AHHA) recommends that your wood fire's firebox and flue be inspected every 12 months. You can do this yourself, or you can call your local chimney sweep. The cost for replacements or repairs is based on the use of your unit.

So, if your unit is under pressure for long periods you may have to replace items more often.

CAN I USE AN EXISTING FLUE SYSTEM FOR MY NEW WOOD FIRE?

Unfortunately, no. It is recommended that all Scandia appliances be installed using the recommended Scandia flue kit and extensions.

HOW IMPORTANT IS KW OUTPUT?

Heat is rated in kilowatts (kW). So each wood fire is graded on the amount of kW it can produce. The amount of kW you might require depends on how large and well-insulated your room is.

A fan-forced convection wood fire does not rely on a large kW output. The aim is to utilise the circulated warm air again and again and not let it escape through the flue. Conversely, a radiant wood fire creates less energy (using less wood) but effectively transfers those kW from the wood fire to your home.

CAN I INSTALL MY WOOD FIRE MYSELF?

Unfortunately, no. Wood fires and fireplaces require a qualified professional to install them whose work conforms with local council regulations, Australian Standards & manufacturers' recommendations.

WHERE ARE SCANDIA WOOD FIRES MADE?

Scandia is an Australian-owned company and our wood fires are designed and developed in Australia and manufactured in our purpose-built factories in China using CNC laser technology and robotics to manufacture our products to an impeccable quality.

CHOOSING THE WOOD FIRE THAT'S BEST FOR YOU.

First, let's identify your needs: Is this going to be your primary source of heat? Or are you looking to change the aesthetics of your home? If it's a primary heat source, you'll need to consider layout, ceiling height, insulation type and windows. The output of heat is measured in building squares: 1 square being approx. 10m². So accurate measurements of your home will help you to determine the right wood fire for you. If your choice is based more on ambience, then a small to medium size option would suit your needs.

CHOOSING THE RIGHT FLUE...

There are two things to consider – style & safety. While the 'in-house' portion of your flue offers two options – Sleek Black or Mesh Black – the external portion of your flue and the height required will be mandated by national standards. Please check with your installer for assistance with this need.



THE DETAILS

CONSIDER THE ENVIRONMENT

When choosing the right unit for your home it is important to consider the environment in which it is intended to operate. A wood fire installed in a home with high ceilings, large glass windows or poor insulation may require a unit with a larger output. Clearance to combustible items should be the primary consideration when selecting the location for your wood fire. Proximity to combustible floors, furniture, window dressings, plaster walls, etc. must all be considered when determining where to position your wood fire.

FLUE PERFORMANCE

Flue performance can be influenced by many factors. Choosing the correct location for the unit in your home, and ensuring minimal bends for the flue will support the prolonged performance of your wood fire over time. Consult your installer to discuss current Australian standards.

VENTILATION IS IMPORTANT!

Wood fires require oxygen to function. The flue draws air from the room into the firebox through a primary air slide. If the room where the wood fire is installed experiences "negative pressure" or is well sealed and insulated the wood fire may not get enough air to operate at its optimal levels. During your site assessment, an installer may recommend installing a vent or another form of delivering air to your wood fire.

HOW BIG IS THE AREA YOU WANT TO HEAT?

It is important to select the wood fire that best suits the environment in which it will operate. If the wood fire is too large it may have increased levels of smoke and operate at less than optimum capacity. If the wood fire is too small it may not heat the required area and over fire the unit which can reduce the effective life span of the unit.

CHOOSING A FAN-FORCED CONVECTION WOOD FIRE

Scandia Fan-forced convection wood fires draw cool air in from the bottom of the room and circulate it between the outside of the firebox and the outer casing of the wood fire, gently warming it before expelling it back into the room.

CHOOSING A RADIANT WOOD FIRE

When choosing a radiant wood fire it is important to consider that it is the external surface of the wood fire that "radiates" heat to warm objects around the fire. The closer in proximity to the fire, the warmer the object. Radiant heaters are great for both indoors and outdoors are preferred by those who like to "feel" the fire whilst watching the flames.

WHY DO I NEED A HEARTH?

Where a wood fire is installed on a combustible surface a hearth is required. Hearths are designed to protect combustible materials from radiant heat and to protect floor coverings from falling embers.

INSTALLATION OF THE WOOD FIRE

Your wood fire must be installed by a licensed professional.

STRAIGHT WALL INSTALLATION



Details for straight wall hearth pad requirements are located in the owner's manual and are specific to each individual wood fire.

CORNER WALL INSTALLATION

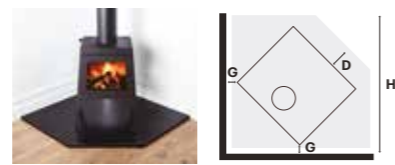

Corner installations have different clearance requirements and it is imperative that installation is in accordance with manufacturers specifications.

COMPARING SCANDIA APPLIANCES

	FREESTANDING	INBUILT	RADIANT HEATING	FAN ASSISTED CONVECTION HEATING	COOKING/WARMING
FRAAM HORIZON	●			●	
FRAAM SHEER	●			●	
SUPREMACY 300	●			●	
SUPREMACY 200	●			●	
WARMBRITE 140	●		●		●
WARMBRITE 200	●			●	
WARMBRITE 300	●			●	
AUSTRALIS M	●			●	
AUSTRALIS L	●			●	
EDGE 50	●		●		●
HEAT & COOK	●		●		●
WARMBRITE INBUILT 280i		●		●	

Note: When cooking and warming please remember to take care of your wood fires's surface by immediately cleaning spills with a cloth and warm water, making sure the surface is dry before resuming cooking.

YOUR WOOD FIRED HEATING CHECK LIST

THINGS TO CONSIDER

There are important factors to consider when making your choice for the perfect woodfire for your home. We've created a preliminary checklist to assist you in making the best selection.

	Is my wood fire the primary source of heating?
	How big is the area you want to heat?
	Is the house single storey or double storey?
	Radiant or Fan-forced Convection?
	Where is the unit going to be installed?
	Traditional or Contemporary?
	What are my installation requirements and who will install the unit?
	Do I need council approval?

PURCHASE CHECKLIST

STEP 1: CHOOSE YOUR APPLIANCE

Please tick the type of appliance that you would like for your home.

- WOOD FIRE ELECTRIC FIRE

Taking into consideration, clearance and installation guidelines, choose the appliance that best suits your home.

ITEM NO. (3171487)	APPLIANCE: (EDGE 50)	TICK

STEP 2: PURCHASE INSTALLATION ACCESSORIES

2.1 CHOOSING YOUR FLUE KIT (Refer to page 32-34)

Always install an appliance with a matching flue kit (decorative, sleek black). Please select your wood fire installation or appliance type in order to determine which flue kit you require.

- FREESTANDING
 INBUILT (MASONRY)
 INBUILT (ZERO CLEARANCE)

ITEM NO.	FLUE KIT:	ORDERED

2.2 CHOOSING YOUR HEARTH PAD (Refer to product specific page)

If you are installing your freestanding wood fire on a combustible surface you will require a hearth pad. Please tick your installation type:

- STRAIGHT INSTALLATION CORNER INSTALLATION

ITEM NO.	HEARTH PAD:	ORDERED

2.3 CHOOSING YOUR ROOF FLASHING (Refer to page 32-34)

Select which type of roof flashing you require:

- TILE ROOF IRON ROOF

ITEM NO.	3171672 - SCANDIA TILE ROOF FLASHING 3171673 - SCANDIA IRON ROOF FLASHING	ORDERED

2.4 CHOOSING YOUR HEATER GUARD (Refer to page 36)

Scandia provide heater guards to suite all wood fire installations. Please select your installation type before choosing your heater guard size.

- STRAIGHT INSTALLATION CORNER INSTALLATION

ITEM NO.	HEATER GUARD:	ORDERED

Please note: It is a requirement that all Scandia solid fuel appliances are fitted by a qualified, licensed installer whose work complies with local council regulations, Australian standards and manufacturer's specifications. Failure to correctly install is extremely dangerous, will void any warranty claims and may compromise any future insurance claims.

STEP 3: ADDITIONAL INSTALLATION PARTS

Nominate any additional parts you may require. (This could include flue extensions, 45° bends, penetration box etc.)

ITEM NO.	DESCRIPTION:	ORDER

STEP 4: CHOOSE YOUR WOOD FIRE ACCESSORIES

Scandia provide a complete range of tools and accessories to complement and enhance your wood fired experience.

4.1 CHOOSING YOUR WOOD STORAGE (Refer to page 42-44)

- FREESTANDING INDOOR
 WALL MOUNT OUTDOOR

ITEM NO.	WOOD STORAGE:	ORDERED

4.2 CHOOSING YOUR FIRE TOOL SET (Refer to page 45)

ITEM NO.	FIRE TOOL SET:	ORDERED

NOTES

HOT TIP

- Small Heater Guards are suitable for 1050 x 1050 and 1050 x 1200 Straight Wall Hearth Pads
- Use the large corner guard for the 1425x1425 corner hearth.
- Large Heater Guards suit 1200 X 1200 Hearth Pads

How It Works

It's as simple as 1,2,3! Follow the steps shown to purchase or order your product. If you need further advice, speak to a team member at the Special Orders Desk in-store.

1. Select The Product You Want

View the extensive range available in this brochure or online. Use the number shown below to order your product online or in-store.



2. Order Online or at the Special Orders Desk

After you have selected the product you want, take this brochure to the Special Orders Desk or order online at bunnings.com.au

3. Get It Home

We Will Deliver

Delivery to your home or site can be arranged online or in-store when purchasing your products.

Pick-Up In-Store

If you decide to pick-up in-store and need help to get it home, you can:

- borrow a courtesy trailer
- hire a vehicle

Check with your local Bunnings store for availability.

Ask us about Additional Services

Scandia Heating (Aust) Pty Ltd
 58 Access Way
 Carurm Downs VIC 3201
 Australia

1300 HEATER (432 837)
service@scandiaheating.com.au
www.scandiaheating.com.au

EST. 1953 | **OVER 70 YEARS OF WARMTH**
FOR SEVEN DECADES,
WE'VE BUILT THE HEATER.



Since starting our journey over 70 years ago, we've engineered thousands of wood heaters... We build the heaters, you bring the power of fire to life.

NOW, WE WANT TO SEE WHERE IT LIVES.



SHOW US YOUR HEATER.

Share a photo of your wood heater in its natural habitat. The coziest entries will be featured on our socials!

-  **SNAP IT:** Capture the atmosphere.
-  **TAG IT:** @scandia_australia, @scandiaaustralia
-  **SEND IT:** marketing@scandiagroup.com.au



Scandia

The power of fire

www.scandiaheating.com.au

1300 432 837



V 06/26

 [scandiaaustralia](https://www.facebook.com/scandiaaustralia)

 [scandia_australia](https://www.instagram.com/scandia_australia)

 [scandiaheating](https://www.pinterest.com/scandiaheating)

 [scandigroupptyltd4468](https://www.youtube.com/scandigroupptyltd4468)