

SECTOR[®]

PANEL FENCING



Sound



Simple



Fast



AVAILABLE IN FIVE STYLES AND TWO NEW COLOURS:

FRONTIER

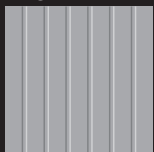

BORDERLINE



BREEZELINE



BLOCKADE

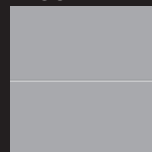

STYLELINE



*Flax matches Dulux flaxpod Powdercoat.

Two Pre-Primed Ready To Paint Options





New Zealand's most adaptable fencing system

***SECTOR Fencing is a simple,
modular, easy-to-build fencing
system, which can also be
customised to add a stylish look to
complement the features of any home.***



Anyone with basic handyman skills could construct an attractive and durable fence which will add value and privacy to your property. Simply install the posts, slide in your choice of panels and with a few finishing touches, you're done.



The system is totally flexible and adaptable. All panels are compatible and can be combined in whichever configuration you require to protect and complement your property.

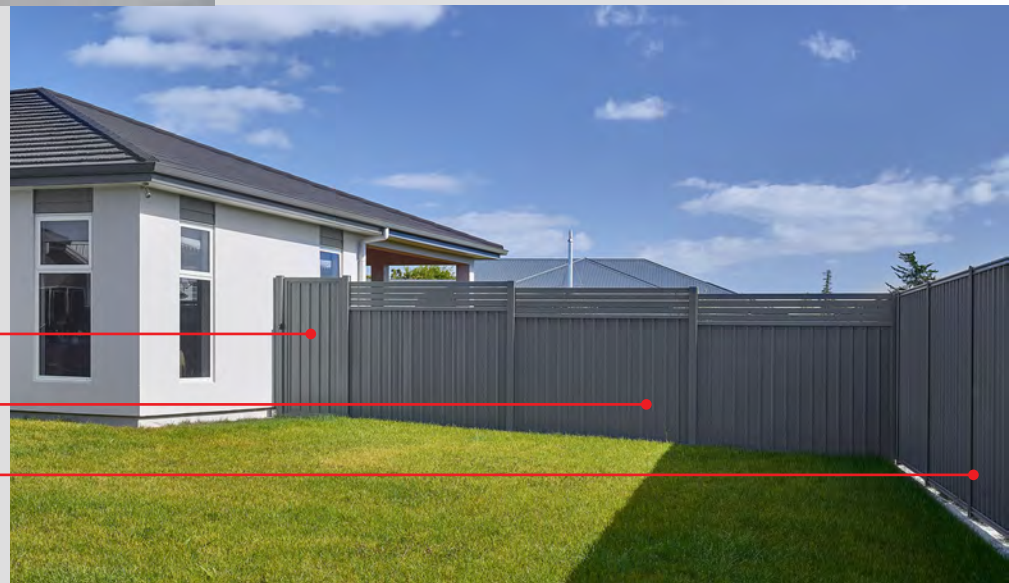

COLOURED STEEL GATE

BORDERLINE

FRONTIER

Why choose **SECTOR**?

Strong, versatile, easy to install and built to last. With great sound barrier qualities and a choice of options to add value to your investment.

Sound

The composite wall panels laminated with fibre cement board in the **Blockade** range have highly effective noise reduction properties. With a 20+ dB audible reduction in traffic and general neighbourhood noise, this fencing system is ideal if minimising roadside noise is a priority.

*Reduces noise by more than 20dB**

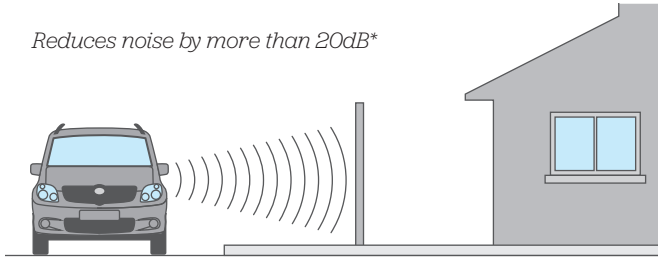

*Applies to Blockade only.



Simple

Featuring simple DIY installation methods, the entire SECTOR Fencing range is popular with homeowners wishing to install their own fence. Measure the length of fencing required and a simple calculation will allow you to order the correct number of panels and posts. Once the postholes have been dug and posts inserted, the standard length panels can be quickly slotted into place.

Of course, we are here to help with any questions you have, or if you need an accredited installer. Just call us on

0800 235 2473

Fast

For most residential properties, the entire fence can be installed within a day. Utilising the cleverly designed modular system and simple installation method, you too can have that designer 'wow' look overnight and make your neighbours jealous.

Stunning and adaptable

SECTOR Blockade panel sections are designed to be painted using standard exterior acrylic paint finishes or textured coatings, allowing you to match your fence to the colour of your home.

By including decorative slats, the **Styleline** panel system creates a stylish and customised look to complement the features of any home. Opt for slats with **Borderline** sheeting sections for a cost-effective solution, or use **Breezeline** to enclose and protect private areas. Any combination will add the finishing touch to your new boundary investment.

Made in New Zealand

Made in New Zealand from high quality components, the system offers a strong and durable boundary solution in any climate.

10
YEAR
WARRANTY

Satisfaction guaranteed!

If any component of the supplied fence fails – we will replace it!

Ensure your fence is built and secured to our supplied instructions as a minimum.

The Warranty does not cover damage or loss through act of God.





FRONTIER

Strong and durable coloured steel sections

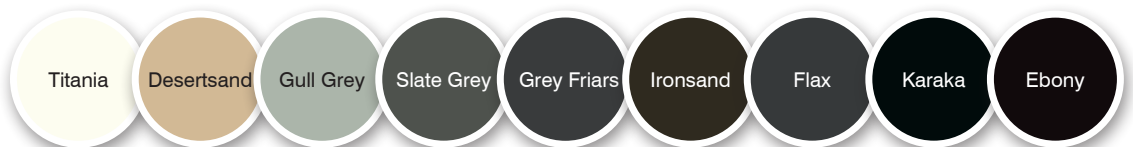
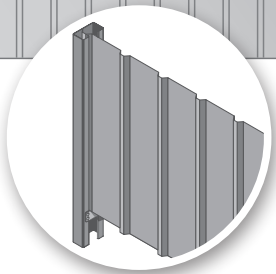
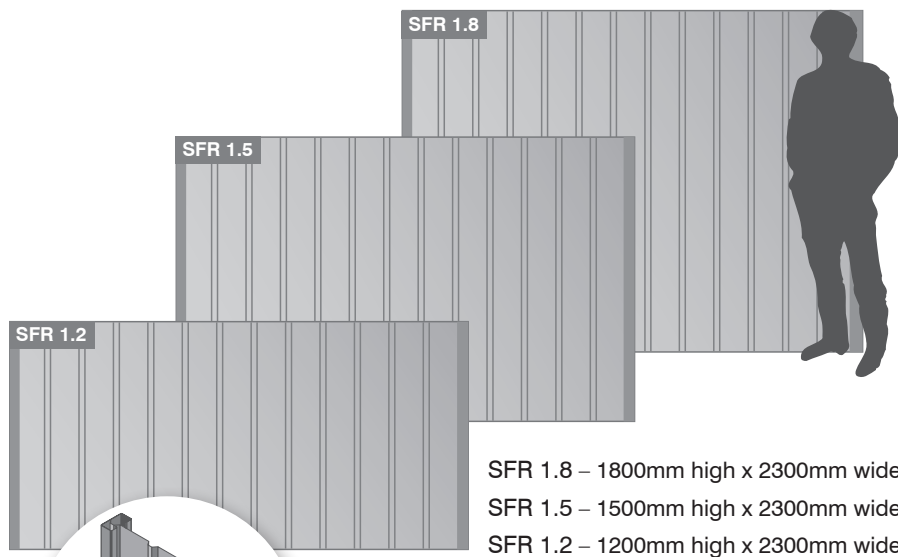

Colours: Post and insert colours can be combined. Colours must be specified on ordering.

Each FRONTIER panel includes:

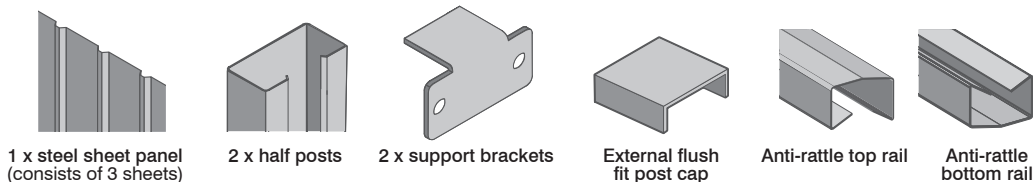

Assembly required – all fixings are supplied.



BORDERLINE

Durable coloured steel sections with rail trim

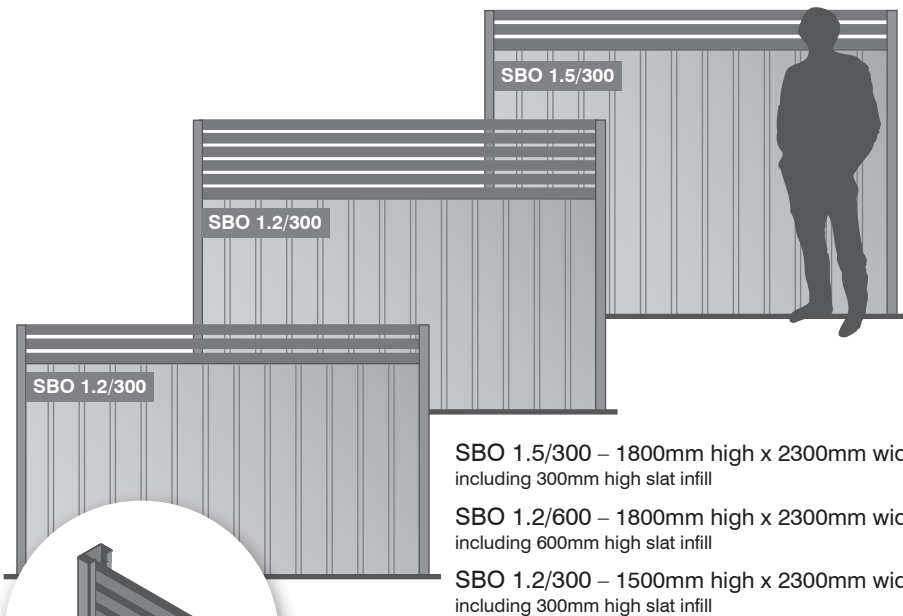

SBO 1.5/300 – 1800mm high x 2300mm wide including 300mm high slat infill

SBO 1.2/600 – 1800mm high x 2300mm wide including 600mm high slat infill

SBO 1.2/300 – 1500mm high x 2300mm wide including 300mm high slat infill

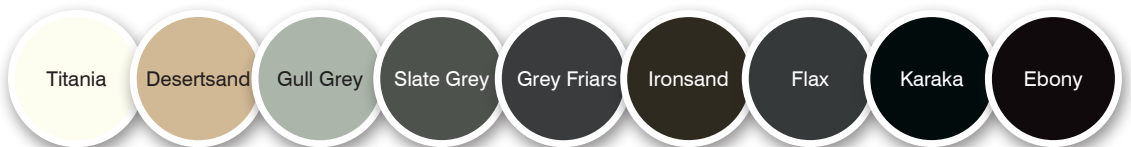

Colours: Post and insert colours can be combined. Colours must be specified on ordering.

Each BORDERLINE panel includes:

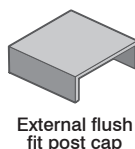
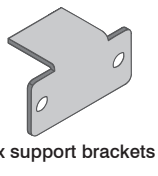
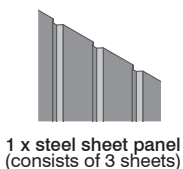

Assembly required – all fixings are supplied.



BREEZELINE

Secure with that open feeling

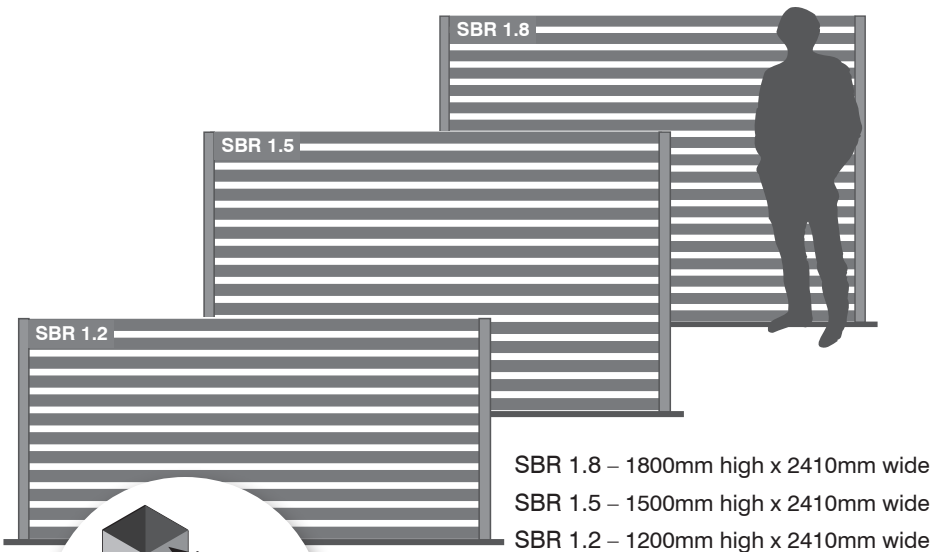

SLATS - 85mm x 25mm

In addition to the SBR 1.8, SBR 1.5 and SBR 1.2 panel kits, we can also supply Breezeline components individually:

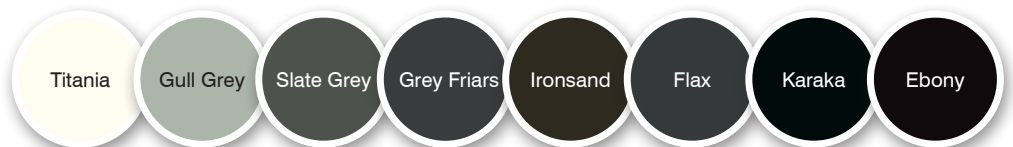
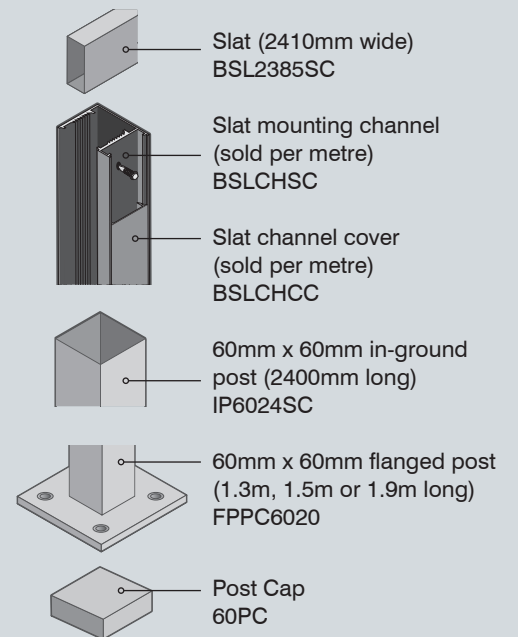

Colours: Post and insert colours can be combined. Colours must be specified on ordering.

Each BREEZELINE panel includes:



12, 15 or 18 slats

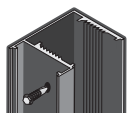

2 x Slat mounting channel

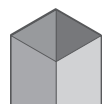

1 x 60mm x 60mm in-ground post

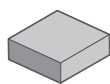

60mm x 60mm post cap

Optional extras:

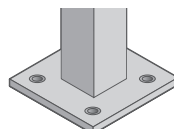

60mm x 60mm flanged post

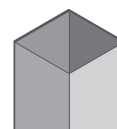

90mm x 90mm in-ground post

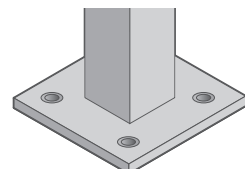

90mm x 90mm flanged post

Assembly required – all fixings are supplied.



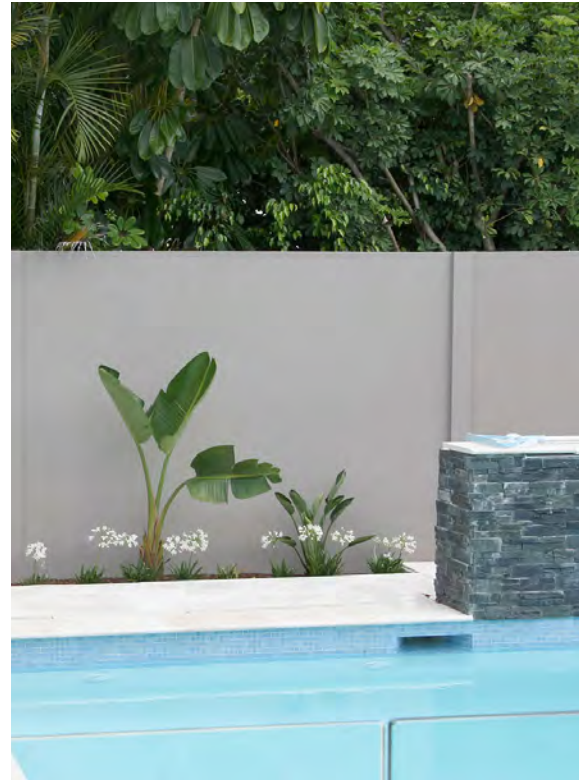
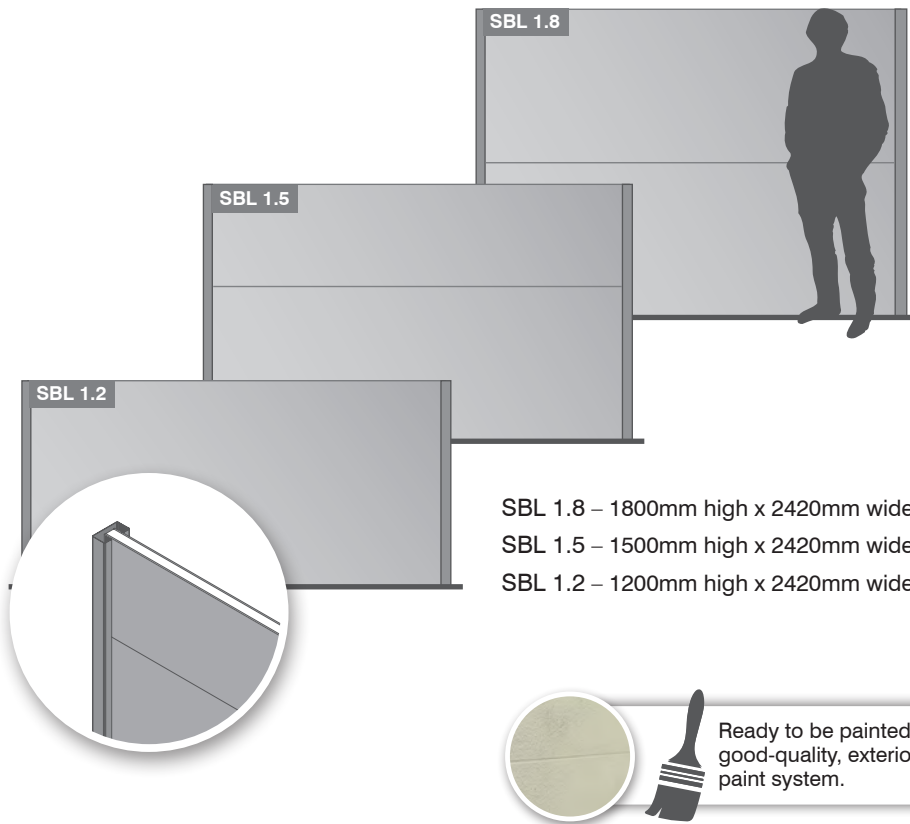

BLOCKADE

Brilliant acoustic sound blocking

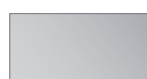

Each BLOCKADE panel includes:

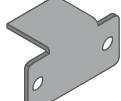
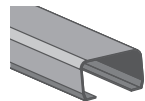
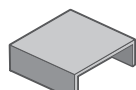
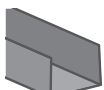
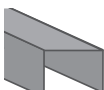
- 
1 or 2 composite panels
- 
2 x half posts
- 
2 x support brackets
- 
1 x joining profile (for 1.8 and 1.5 sizes)
- 
External flush fit post cap
- 
Capping channel bottom
- 
Capping channel top

Assembly required – all fixings are supplied.



STYLELINE

Privacy and sound blocking with some airflow

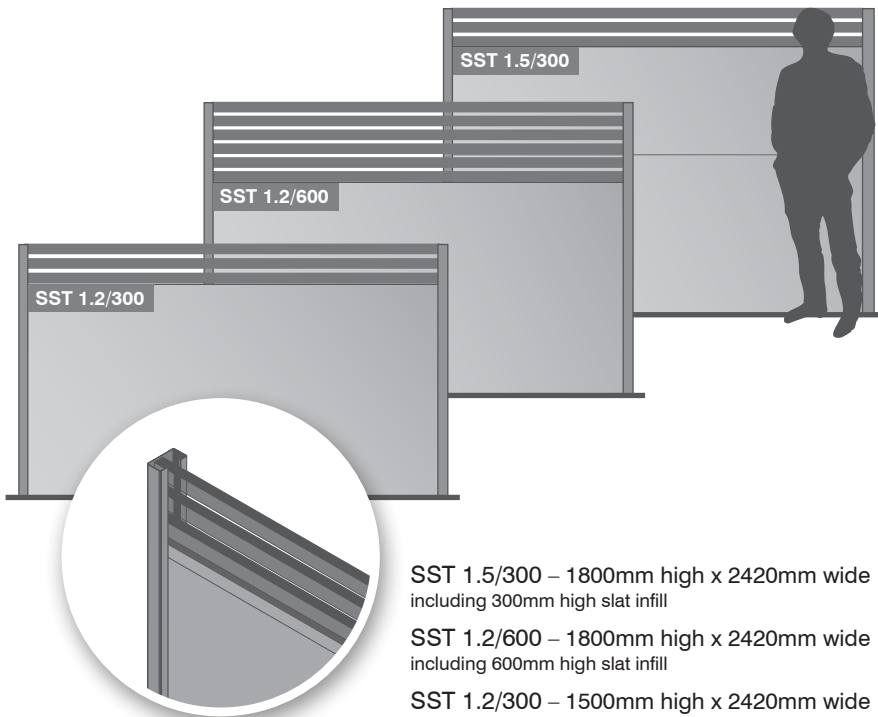

SST 1.5/300 – 1800mm high x 2420mm wide including 300mm high slat infill

SST 1.2/600 – 1800mm high x 2420mm wide including 600mm high slat infill

SST 1.2/300 – 1500mm high x 2420mm wide including 300mm high slat infill



Ready to be painted with any good-quality, exterior, self-priming paint system.

Each STYLELINE panel includes:

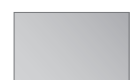

1 or 2 composite panels



3 or 6 aluminium slats



2 x half posts

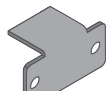

2 x support brackets

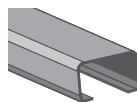

1 x joining profile (for 1.8 with 300mm infill)

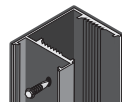

2 x Slat mounting channel

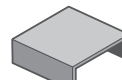

External flush fit post cap



Capping channel bottom

Assembly required – all fixings are supplied.



GATES

Sector gates come with high quality stainless steel hinges and a lockable latch, and are 900mm wide to fit a 925mm opening.

Gate posts, if required, should be ordered separately.

Custom gate sizes are available on request.

COLOURED STEEL GATE
Code: SSHG



GATE POST 90mm x 90mm
in-ground or flanged options
available (order separately)



Colours: Gate and post colours can be combined. Colours must be specified on ordering.

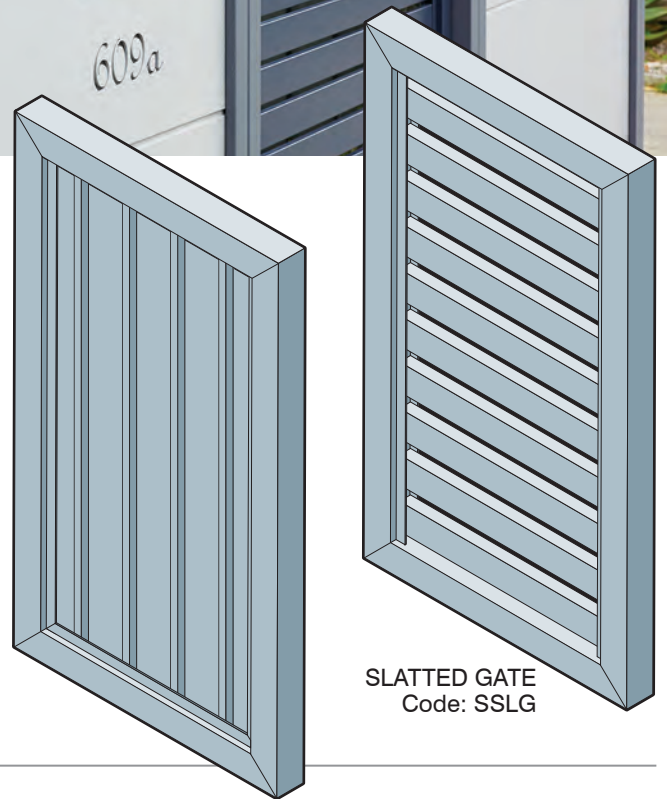

SLATTED GATE
Code: SSLG

ECO SLAT GATE KIT

Code: ECSG

Introducing our new, economical, cut-to-size, kitset slat gate (maximum size 1800mm high x 1000mm wide).

Supplied in kit form as two 1800mm high channels, 18 x 1000mm wide slats (85mm x 25mm), high quality stainless steel hinges and a lockable latch.

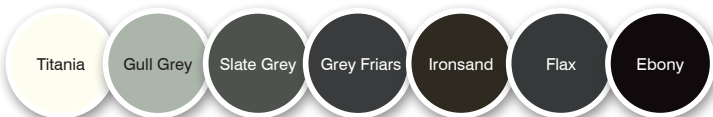

Colours: Gate kit and post colours can be combined. Colours must be specified on ordering.

You can cut down the channels and the slats to create your desired size. Then simply assemble your gate and the sliding plate covers will cover the screws to provide a professional finish.

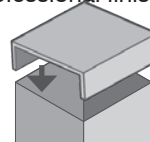

GATE POST - 90mm x 90mm
in-ground or flanged
+ flush fit post cap

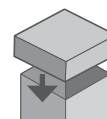

GATE POST - 60mm x 60mm
in-ground or flanged + post cap

Gate posts, if required, should be ordered separately.

Photo:
Double Eco Slat Gate Kits shown, cut down in height to 1500mm (15 slats)

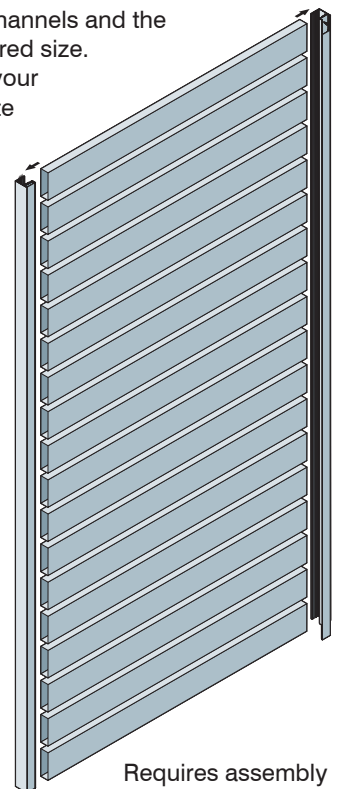

Requires assembly

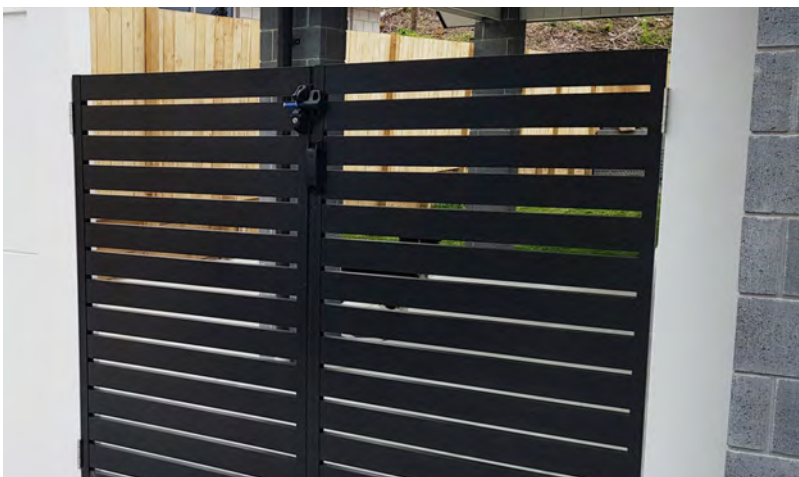

POST CONFIGURATIONS

Below are the different configurations for the sector posts.

Each panel comes with two 90mm x 45mm half posts or one 60mm x 60mm post (Breezeline), so you only need to order the additional elements in red to achieve your desired configurations.

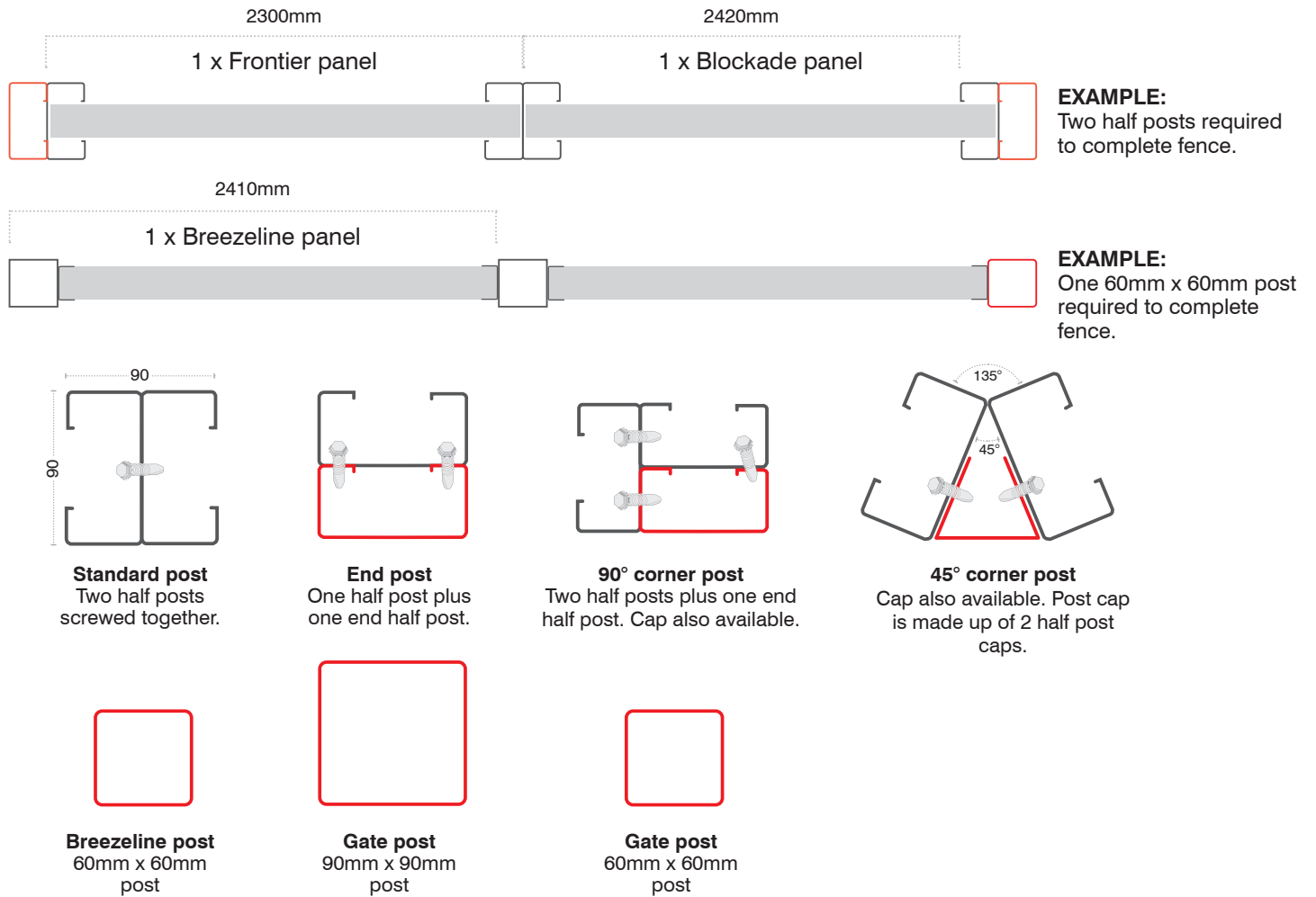

SECTOR FEATURES

Our 0.3mm high tensile sheet steel (0.95mm for posts and rails) is thicker than that of many of our competitors, and receives three generous coatings, on both sides, to ensure maximum protection from corrosion.

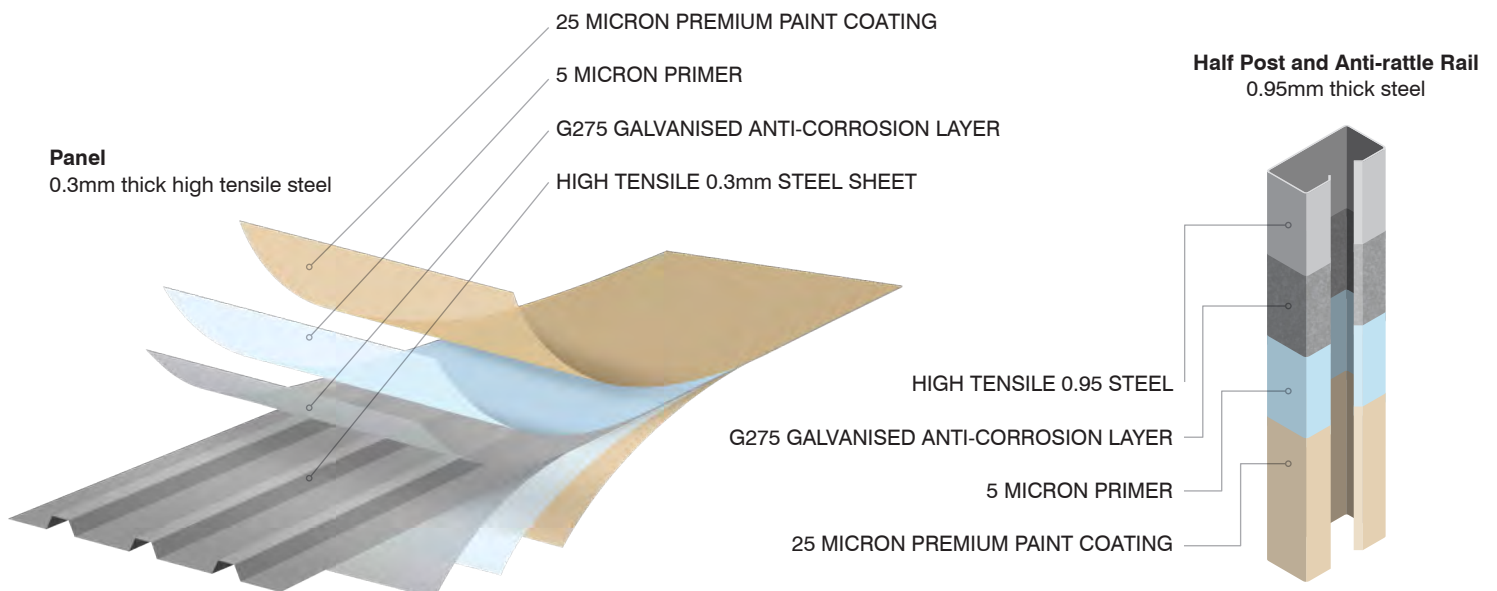

Ordering information

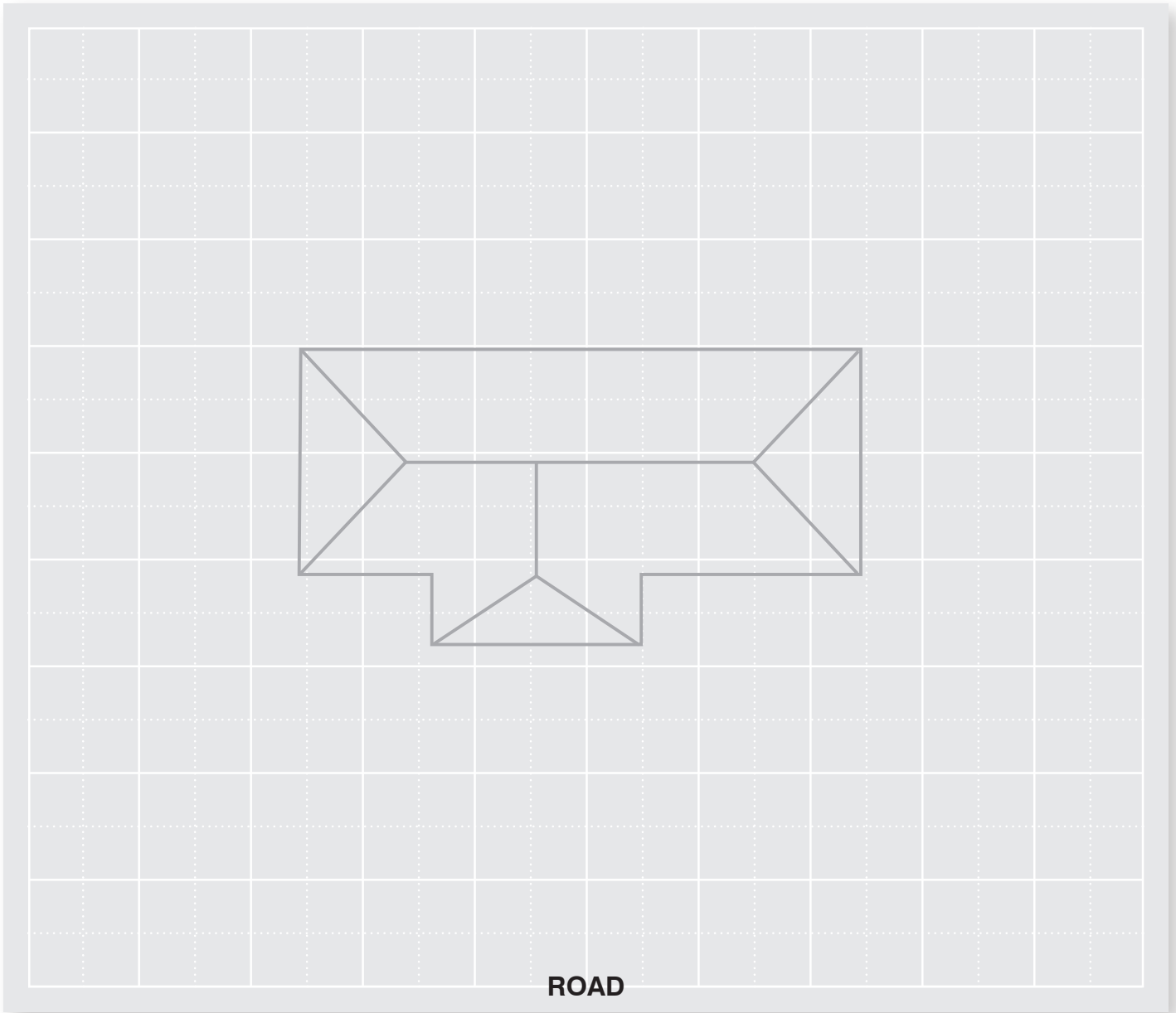

Sample sketch

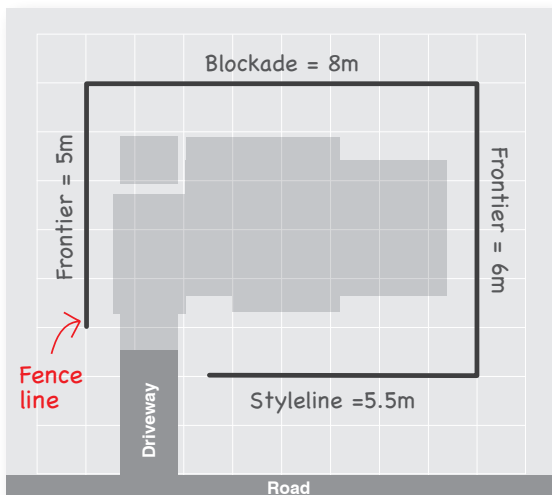

Notes

.....

.....

.....

.....

.....

.....

.....

.....

.....

.....

Continued over...



Order form



YOUR DETAILS

Name
 Address
 Phone Mobile
 Email
 Signature

RETAILER DETAILS

Retailer name
 Store signature

PANELS

Example

Code	Length (m)		Panel width (m)		Panels required (round up to nearest full panel)	Panel colour	Post colour (2 half posts per panel)
SFR 1.8	5	÷	2.3	=	3	Ebony	Gull Grey
SST 1.5/300	9	÷	2.42	=	4	-	Ironsand

Code	Length (m)		Panel width (m)		Panels required (round up to nearest full panel)	Panel colour	Post colour (2 half posts per panel)
		÷		=			
		÷		=			
		÷		=			
		÷		=			
		÷		=			
		÷		=			

GATES & ECO SLAT GATE KITS

Code	No. required	Colour

EXTRA POSTS & GATE POSTS

Post type	No. req.	No. of caps	Colour



PO Box 3030, Hawke's Bay Mail Centre,
 Napier, New Zealand 4142
 Tel: 0800 235 2473
 info@sectorfencing.co.nz
 www.sectorfencing.co.nz

