



S300 INSTALLATION GUIDE

General Installation

1. Remove roofing tiles or lift roof sheets to achieve an opening to fit the Roof Extenda bracket.
2. Bolt angle bracket with the threaded rod & backing plate to the selected rafter with 2 or 4 x M12 hex bolts. Secure the bracket to the top plate with 2-M10 coach screws through the two lower bottom holes.
3. Replace roof tiles or roof sheet, cutting a hole to allow the threaded rod to penetrate the roof.
4. Ensure you seal the centre hole in the top bracket for further weather proofing.



Care Instructions

Roof Extenda recommends painting mild steel brackets before installation. Brackets to be cleaned and inspected yearly and re-coated if required.

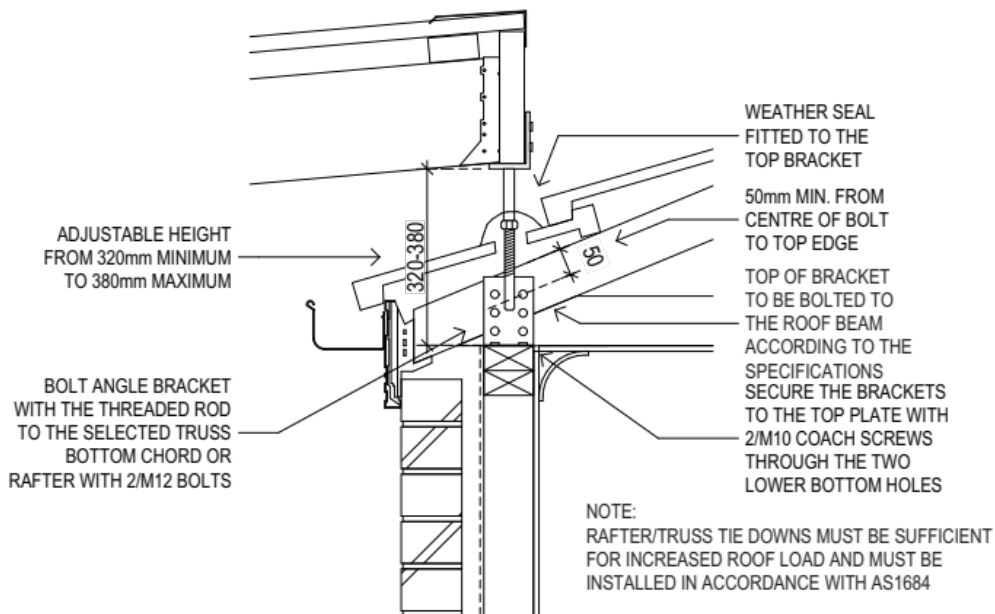

S300

Adjustable height from 320mm to 380mm maximum

Note

Local Council or Shire approval may be required prior to construction. Engineer's computations related to Roof Extenda products are available on the website. Roof Extenda accepts no responsibility for the type of construction undertaken. If located in a highly corrosive area, Roof Extenda recommends 316 marine grade stainless steel brackets.

FlashRite Weather Seal

If using a FlashRite weather seal it is fitted to the top bracket.

- 1 Cut cone to exact corresponding pipe diameter. We recommend a sharp pair of scissors to cut our pipe flashing for the correct pipe size. Ensure there are no accidental nicks in the polymer, as this will continue to split/tear over time.

Tip: Ensure the blades are sharp with no contamination e.g. glue or any accumulated dirt.

- 2 Lubricate the top bracket with water prior to attaching the weather seal.
- 3 Attach the weather seal to the top bracket then wind the top bracket down to the desired height and lock the hex nut tightly.
- 4 Form the weather seal to the profile of the roof and mark out the position of the weather seal.
- 5 Slide the weather seal up the bracket to apply neutral cure sealant inside the area marked, press the weather seal into position and finish with a bead of sealant to the edges of the weather seal to complete the fitting.
- 6 Realign weather seal onto roof and fix with Class 3 or Class 4 hex head self-drilling screws minimum of 16mm long with a rubber washer.

CUT CONE TO EXACT CORRESPONDING BRACKET PIPE DIAMETER

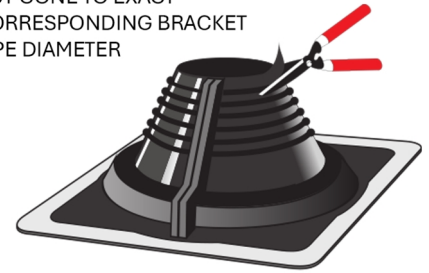

WHEN SLIDING FLASHING DOWN TOP BRACKET PIPE WITH WATER

FORM TO ROOF PROFILE

MARK OUT SEALANT PATHS

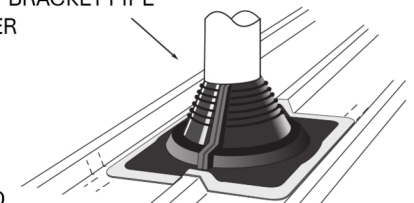

LIFT FLASHING UP TOP BRACKET PIPE

APPLY SEALANT ON MARKED PATH

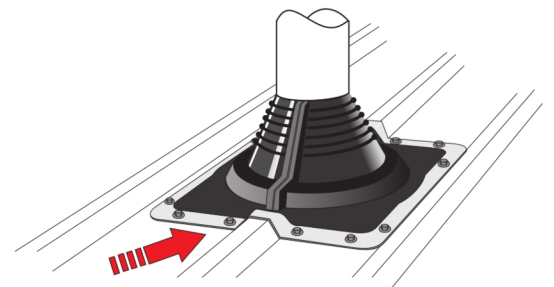
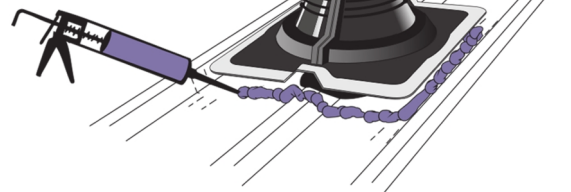

REALIGN FLASHING ONTO ROOF AND FIX WITH APPROPRIATE FASTENERS. START HERE.

If Retro-Fitting a Weather Seal:

SPLIT SHOULDERS WITH SCISSORS

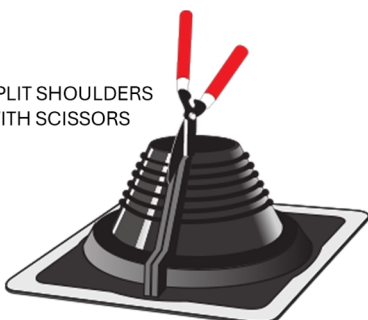

CRIMP FLASHING SHOULDERS WITH RETROFIT CLIPS. FACE JOINT DOWNSTREAM.

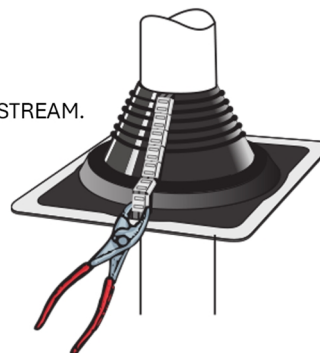

Flexatile

- 1** Ensure tiles are cleaned before installing the Flexatile flashing to ensure the butyl adhesive strips can have maximum effect when bonded to the tiles.
- 2** Cut the rubber cone at least 15mm smaller than the top bracket pipe's outside diameter with a sharp pair of scissors. Ensure there are no accidental nicks in the polymer, as this will continue to split/tear over time.

Tip: Ensure the blades are sharp with no contamination e.g. glue or any accumulated dirt.

- 3** Remove the middle lining from the underside of the flexatile.
- 4** Lubricate the top bracket with water and slide the flashing down the bracket.
- 5** Form an anti-capillary fold at top of base sheet.
- 6** Remove the protective backing from the underside of the flashing, that is covering the butyl adhesive strips.
- 7** Hand form the base all around the tile and apply pressure to the butyl adhesive side strip.

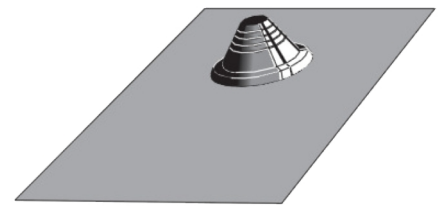

BASE SHEET CHOICE
a) ACRYFLASH
b) ALUMINIUM
c) RE-INFORCED POLYMER

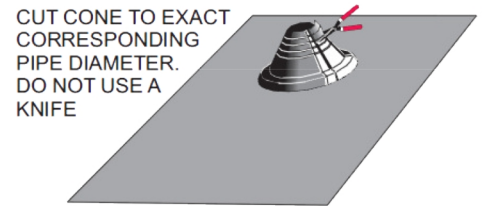

CUT CONE TO EXACT CORRESPONDING PIPE DIAMETER. DO NOT USE A KNIFE

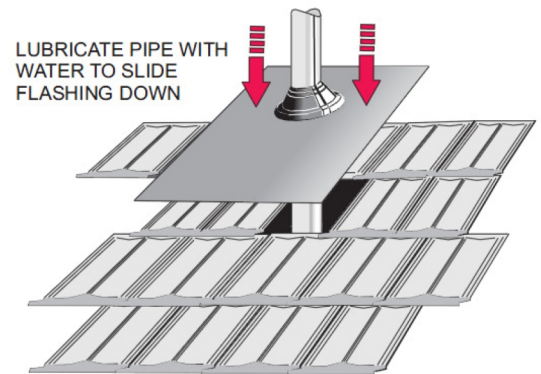

LUBRICATE PIPE WITH WATER TO SLIDE FLASHING DOWN

FORM AN ANTI-CAPILLARY FOLD AT THE TOP OF THE BASE SHEET

ENSURE ANTI CAPILLARY FOLD IS NOT DEFORMED AT TOP

DOUBLE SIDED FOAM TAPE IS AVAILABLE FOR BOTH SIDES

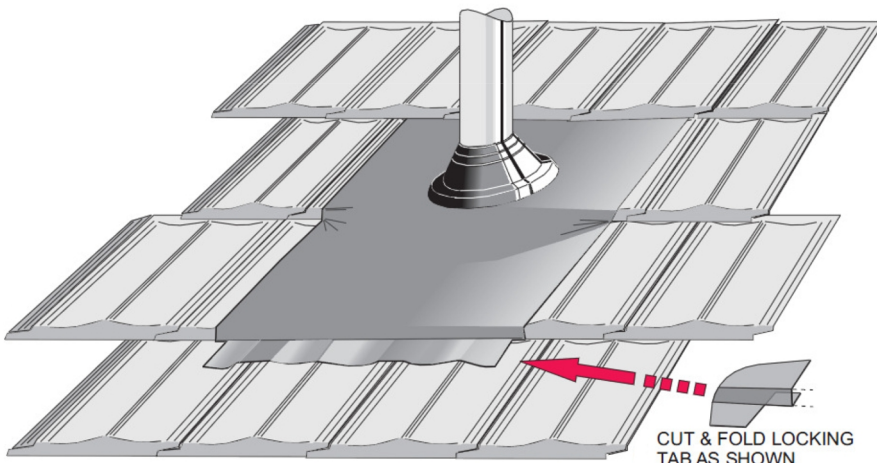
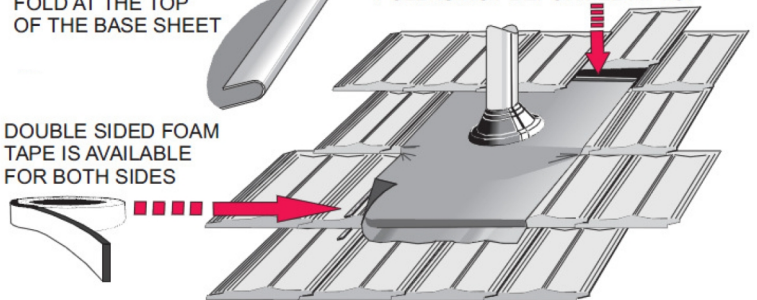

CUT & FOLD LOCKING TAB AS SHOWN