

ozito

CORDLESS STAPLE NAIL GUN

3.6V LI-ION

INSTRUCTION MANUAL SPECIFICATIONS

Input:	3.6V
Battery:	1.5Ah Li-Ion
Charging Time:	3 hours
Firing Rate:	30/min
Staple Size:	4-8mm T50 or JT21
Nail Size:	10mm C1 Brad
Magazine Capacity:	100 x JT21 Staples or 60 x T50 Staples or 100 x 10mm Nails
Weight:	0.94kg

ozito.com.au



STANDARD EQUIPMENT

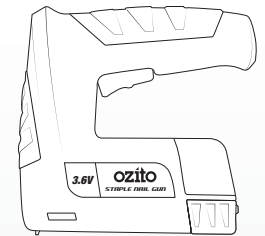

Cordless Staple Nail Gun

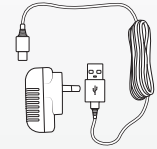

Charge Adaptor & USB Type C Cable

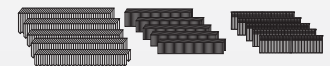

1000 x 8mm T50 Staples, 1000 x 8mm JT21 Staples & 500 x 10mm C1 Brad Nails

3 YEAR
REPLACEMENT
WARRANTY*

SNGK-036

WARRANTY

IN ORDER TO MAKE A CLAIM UNDER THIS WARRANTY YOU MUST RETURN THE PRODUCT TO YOUR NEAREST BUNNINGS WAREHOUSE WITH YOUR BUNNINGS REGISTER RECEIPT. PRIOR TO RETURNING YOUR PRODUCT FOR WARRANTY PLEASE TELEPHONE OUR CUSTOMER SERVICE HELPLINE:

Australia: 1800 069 486
New Zealand: 0508 069 486

TO ENSURE A SPEEDY RESPONSE PLEASE HAVE THE MODEL NUMBER AND DATE OF PURCHASE AVAILABLE. A CUSTOMER SERVICE REPRESENTATIVE WILL TAKE YOUR CALL AND ANSWER ANY QUESTIONS YOU MAY HAVE RELATING TO THE WARRANTY POLICY OR PROCEDURE.

The benefits provided under this warranty are in addition to other rights and remedies which are available to you at law.

Our goods come with guarantees that cannot be excluded at law. You are entitled to a replacement or refund for a major failure and for compensation for any other reasonably foreseeable loss or damage. You are also entitled to have the goods repaired or replaced if the goods fail to be of acceptable quality and the failure does not amount to a major failure.

Generally you will be responsible for all costs associated with a claim under this warranty, however, where you have suffered any additional direct loss as a result of a defective product you may be able to claim such expenses by contacting our customer service helpline above.

3 YEAR REPLACEMENT WARRANTY*

Your product is guaranteed for a period of **36 months from the original date of purchase**. If a product is defective it will be replaced in accordance with the terms of this warranty. Warranty excludes consumable parts, for example: valve adapters and accessories.

*This product is intended for DIY use only and replacement warranty covers domestic use.

WARNING

The following actions will result in the warranty being void.

- If the tool has been operated on a supply voltage other than that specified on the tool.
- If the tool shows signs of damage or defects caused by or resulting from abuse, accidents or alterations.
- Failure to perform maintenance as set out within the instruction manual.
- If the tool is disassembled or tampered with in any way.
- Professional, industrial or high frequency use.

KNOW YOUR PRODUCT

CORDLESS STAPLE NAIL GUN

1. Magazine Window
2. Trigger
3. Sure Grip Handle
4. Magazine Latch
5. Charging Socket
6. Fastener Selector
7. Safety Striker Guard
8. On/Off Switch
9. LED Charge Indicator

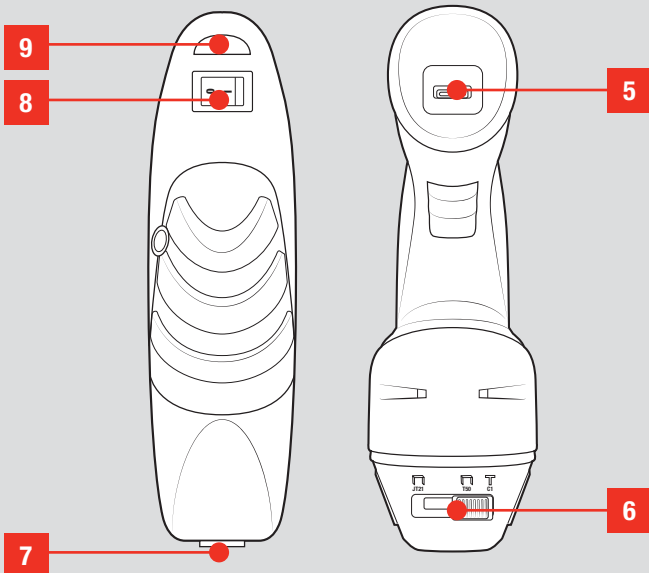
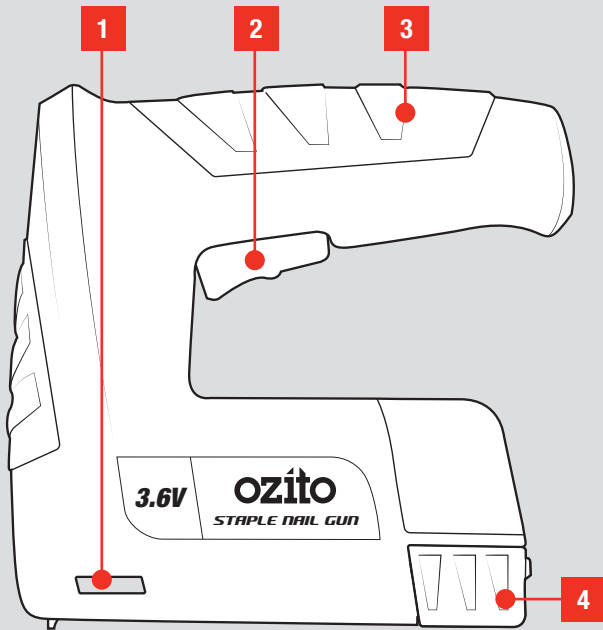

ONLINE MANUAL

Scan this QR Code with your mobile device to take you to the online manual.

3 YEAR REPLACEMENT WARRANTY*



SETUP & PREPARATION

1. BATTERY

WARNING! THE POWER SUPPLY FOR THIS CHARGER SHOULD BE PROTECTED BY A RESIDUAL CURRENT DEVICE (RATED AT 30MA OR LESS); THIS REDUCES THE RISK OF ELECTRIC SHOCK.

Charging

The charge indicator will illuminate red if the battery is low, indicating that the battery needs charging.

1. Plug the USB Type C cable into the charging socket and charge adaptor.

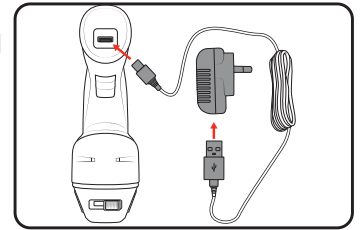

2. Plug the charging adaptor into a power point and switch it on.

Note: The charging indicator will remain red whilst charging.

3. Once fully charged, the indicator light will illuminate green.

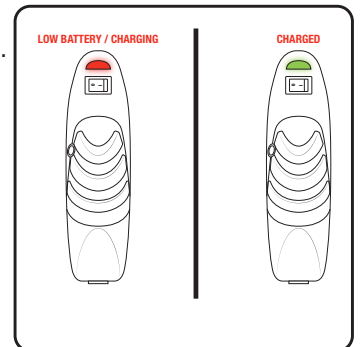

2. FASTENER SELECTION

Staples

Accessories to suit this staple gun can be purchased from Bunnings Warehouse.

This tool accepts staples with the measurements below:

4-8MM T50 STAPLES

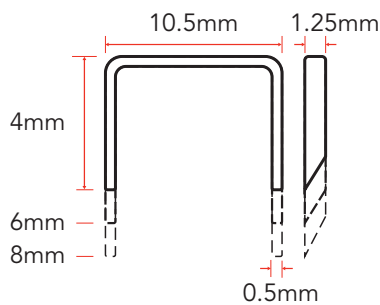

4-8MM JT21 STAPLES

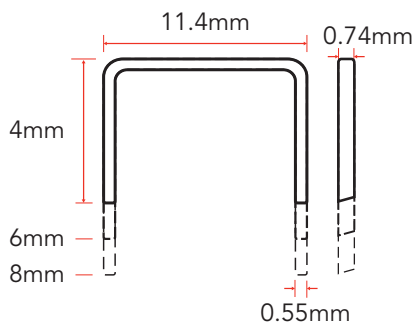

Nails

This tool accepts nails with the measurements below:

10MM C1 BRAD NAILS

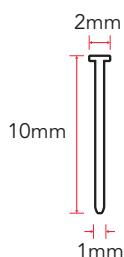

3. LOADING THE MAGAZINE



WARNING! ENSURE THE TOOL IS SWITCHED OFF BEFORE PERFORMING ANY OF THE FOLLOWING OPERATIONS.

Loading Fasteners

This tool only accepts T50 or JT21 staples or C1 Brad nails with the dimensions specified in this manual. Other types of staples, including paper staples, will jam the unit. For best results, load a full row of staples before use.

1. Squeeze the magazine latch and pull the slider out of the tool.

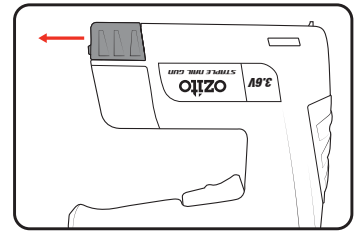

3. Insert a row of staples or nails into the magazine.

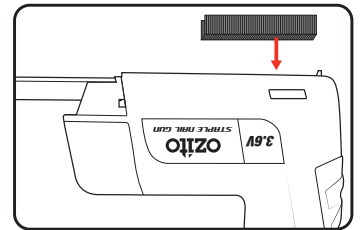

Note: For nails, be sure to align them to the side with the embossed nail icon so that the nail head is against the internal groove.

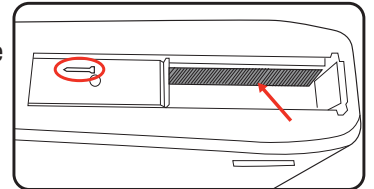

4. Push the magazine slider back into the unit until it clips into place.

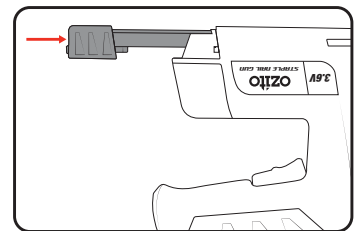

OPERATION

4. CONTROLS

Adjusting The Firing Mode

The mode selector needs to be adjusted to suit the different staple thicknesses.

WARNING! FAILURE TO SET THE CORRECT MODE WILL CAUSE THE TOOL TO JAM OR MISFIRE MULTIPLE FASTENERS AT A TIME.

Move the slider to the right for T50 staples or C1 brad nails.

Move the slide to the left for JT21 staples.

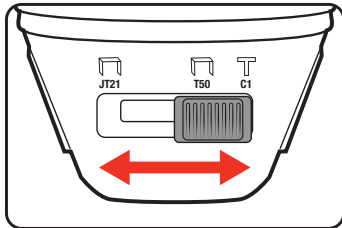

Firing A Staple or Nail

WARNING! ALWAYS USE BOTH HANDS WHEN USING THE TOOL.

The Safety Striker System is a two step process where a staple will only fire when the safety striker guard is pushed against the material to be fastened.

1. With one hand, push down on the back of the tool to press the safety striker guard down onto the work surface.

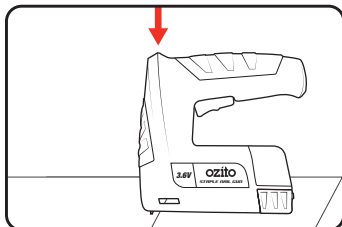

2. To fire the staple nail gun, squeeze the trigger with your other hand.

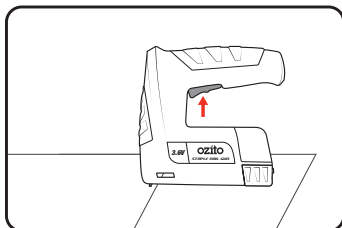

5. TROUBLESHOOTING

WARNING! ENSURE THE TOOL IS SWITCHED OFF BEFORE PERFORMING ANY OF THE FOLLOWING OPERATIONS.

Jammed Staple

1. Squeeze the magazine latch and pull the magazine slider out of the tool.

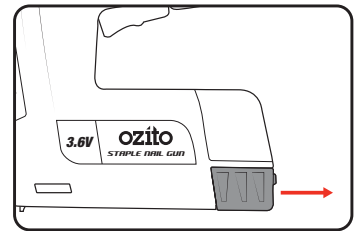

2. Using a pair of pliers, remove any jammed staples/nails.

3. With the magazine still open, tap the safety striker guard against a surface to dislodge any loose fasteners.

Short Battery Runtime

Ensure the battery is properly charged. It will take 4-5 charging cycles before the battery reaches optimum charge and run time.

MAINTENANCE

6. APPLIANCE CARE



WARNING! BEFORE CLEANING THE APPLIANCE OR CARRYING OUT ANY MAINTENANCE PROCEDURE, MAKE SURE THAT IT IS SWITCHED OFF AND DISCONNECTED FROM THE POWER SUPPLY TO PREVENT ACCIDENTAL STARTING.

When not in use, the tool should be stored in a dry, frost free location, keep out of children's reach.

If the housing of the tool requires cleaning, do not use solvents. Use of a cloth only is recommended. Never immerse any part of the tool into liquid.

Note: Ozito Industries will not be responsible for any damage or injuries caused by the repair of the tool by an unauthorised person or by mishandling of the tool.

DESCRIPTION OF SYMBOLS

V	Volts	Hz	Hertz
~	Alternating Current	A	Amperes
/min	Fasteners per minute	—	Direct Current
	Indoor Use Only		Double Insulated
	Regulatory Compliance Mark (RCM)		Transformer Energy Rating (MEPS)
	Wear eye protection		Warning
	Read Instruction Manual		

CARING FOR THE ENVIRONMENT



Power tools that are no longer usable should not be disposed of with household waste but in an environmentally friendly way. Please recycle where facilities exist. Check with your local council authority for recycling advice.



Recycling packaging reduces the need for landfill and raw materials. Reuse of recycled material decreases pollution in the environment. Please recycle packaging where facilities exist. Check with your local council authority for recycling advice.

SPARE PARTS

Spare parts can be ordered from the Special Orders Desk at your local Bunnings Warehouse.

For further information, or any parts not listed here, visit www.ozito.com.au or contact Ozito Customer Service:

Australia 1800 069 486

New Zealand 0508 069 486

E-mail: enquiries@ozito.com.au

ELECTRICAL SAFETY



WARNING! When using mains-powered tools, basic safety precautions, including the following, should always be followed to reduce risk of fire, electric shock, personal injury and material damage. Read the whole manual carefully and make sure you know how to switch the tool off in an emergency, before operating the tool.

Save these instructions and other documents supplied with this tool for future reference.

This tool has been designed for 230V and 240V only. Always check that the power supply corresponds to the voltage on the rating plate.

Note: The supply of 230V and 240V on Ozito tools are interchangeable for Australia and New Zealand.



This tool is double insulated; therefore no earth wire is required.

Note: Double insulation does not take the place of normal safety precautions when operating this tool. The insulation system is for added protection against injury resulting from a possible electrical insulation failure within the tool.

Using an Extension Lead

Always use an approved extension lead suitable for the power input of this tool. Before use, inspect the extension lead for signs of damage, wear and ageing. Replace the extension lead if damaged or defective.

When using an extension lead on a reel, always unwind the lead completely. Use of an extension lead not suitable for the power input of the tool or which is damaged or defective may result in a risk of fire and electric shock.

The power supply for this product should be protected by a residual current device (rated at 30mA or less). A residual current device reduces the risk of electric shock.

GENERAL POWER TOOL SAFETY WARNINGS



WARNING! Read all safety warnings and all instructions. Failure to follow the warnings and instructions may result in electric shock, fire and/or serious injury.

Save all warnings and instructions for future reference. The term "power tool" in the warnings refers to your mains-operated (corded) power tool or battery-operated (cordless) power tool.

1. Work area safety

- Keep work area clean and well lit.** Cluttered or dark areas invite accidents.
- Do not operate power tools in explosive atmospheres, such as in the presence of flammable liquids, gases or dust.** Power tools create sparks which may ignite the dust or fumes.
- Keep children and bystanders away while operating a power tool.** Distractions can cause you to lose control.

2. Electrical safety

- Power tool plugs must match the outlet. Never modify the plug in any way. Do not use any adapter plugs with earthed (grounded) power tools.** Unmodified plugs and matching outlets will reduce risk of electric shock.
- Avoid body contact with earthed or grounded surfaces, such as pipes, radiators, ranges and refrigerators.** There is an increased risk of electric shock if your body is earthed or grounded.
- Do not expose power tools to rain or wet conditions.** Water entering a power tool will increase the risk of electric shock.
- Do not abuse the cord. Never use the cord for carrying, pulling or unplugging the power tool. Keep cord away from heat, oil, sharp edges or moving parts.** Damaged or entangled cords increase the risk of electric shock.
- When operating a power tool outdoors, use an extension cord suitable for outdoor use.** Use of a cord suitable for outdoor use reduces the risk of electric shock.

3. Personal safety

- Stay alert, watch what you are doing and use common sense when operating a power tool. Do not use a power tool while you are tired or under the influence of drugs, alcohol or medication.** A moment of inattention while operating power tools may result in serious personal injury.
- Use personal protective equipment. Always wear eye protection.** Protective equipment such as dust mask, gloves, non-skid safety shoes, hard hat, or hearing protection used for appropriate conditions will reduce personal injuries.
- Prevent unintentional starting. Ensure the switch is in the off-position before connecting to power source and/or battery pack, picking up or carrying the tool.** Carrying power tools with your finger on the switch or energising power tools that have the switch on invites accidents.
- Remove any adjusting key or wrench before turning the power tool on.** A wrench or a key left attached to a rotating part of the power tool may result in personal injury.
- Do not overreach. Keep proper footing and balance at all times.** This enables better control of the power tool in unexpected situations.
- Dress properly. Do not wear loose clothing or jewellery. Keep your hair, clothing and gloves away from moving parts.** Loose clothes, jewellery or long hair can be caught in moving parts.
- If devices are provided for the connection of dust extraction and collection facilities, ensure these are connected and properly used.** Use of dust collection can reduce dust-related hazards.
- Do not let familiarity gained from frequent use of tools allow you to become complacent and ignore tool safety principles.** A careless action can cause severe injury within a fraction of a second.

4. Power tool use and care

- Do not force the power tool. Use the correct power tool for your application.** The correct power tool will do the job better and safer at the rate for which it was designed.
 - Do not use the power tool if the switch does not turn it on and off.** Any power tool that cannot be controlled with the switch is dangerous and must be repaired.
 - Disconnect the plug from the power source and/or the battery pack from the power tool before making any adjustments, changing accessories, or storing power tools.** Such preventive safety measures reduce the risk of starting the power tool accidentally.
 - Store idle power tools out of the reach of children and do not allow persons unfamiliar with the power tool or these instructions to operate the power tool.** Power tools are dangerous in the hands of untrained users.
 - Maintain power tools.** Check for misalignment or binding of moving parts, breakage of parts and any other condition that may affect the power tool's operation. If damaged, have the power tool repaired before use. Many accidents are caused by poorly maintained power tools.
 - Keep cutting tools sharp and clean.** Properly maintained cutting tools with sharp cutting edges are less likely to bind and are easier to control.
 - Use the power tool, accessories and tool bits etc. in accordance with these instructions, taking into account the working conditions and the work to be performed.** Use of the power tool for operations different from those intended could result in a hazardous situation.
 - Keep handles and grasping surfaces dry, clean and free from oil and grease.** Slippery handles and grasping surfaces do not allow for safe handling and control of the tool in unexpected situations.
- ## 5) Battery tool use and care
- Recharge only with the charger specified by the manufacturer.** A charger that is suitable for one type of battery pack may create a risk of fire when used with another battery pack.
 - Use power tools only with specifically designated battery packs.** Use of any other battery packs may create a risk of injury and fire.
 - When battery pack is not in use, keep it away from other metal objects, like paper clips, coins, keys, nails, screws or other small metal objects, that can make a connection from one terminal to another.** Shorting the battery terminals together may cause burns or a fire.
 - Under abusive conditions, liquid may be ejected from the battery; avoid contact.** If contact accidentally occurs, flush with water. If liquid contacts eyes, additionally seek medical help. Liquid ejected from the battery may cause irritation or burns.
 - Do not use a battery pack or tool that is damaged or modified.** Damaged or modified batteries may exhibit unpredictable behaviour resulting in fire, explosion or risk of injury.
 - Do not expose a battery pack or tool to fire or excessive temperature.** Exposure to fire or temperature above 130 °C may cause explosion.
 - Follow all charging instructions and do not charge the battery pack or tool outside the temperature range specified in the instructions.** Charging improperly or at temperatures outside the specified range may damage the battery and increase the risk of fire.
- ## 6) Service
- Have your power tool serviced by a qualified repair person using only identical replacement parts.** This will ensure that the safety of the power tool is maintained.
 - Never service damaged battery packs.** Service of battery packs should only be performed by the manufacturer or authorized service provider.

STAPLE NAIL GUN SAFETY WARNINGS



The appliance is not to be used by persons (including children) with reduced physical, sensory or mental capabilities, or lack of experience and knowledge, unless they have been given supervision or instruction.

Young children should be supervised to ensure that they do not play with the appliance.

- Always assume that the tool contains fasteners.** Careless handling of the stapler can result in unexpected firing of fasteners and personal injury.
- Do not point the tool towards yourself or anyone nearby.** Unexpected triggering will discharge the fastener causing an injury.
- Do not actuate the tool unless the tool is placed firmly against the workpiece.** If the tool is not in contact with the workpiece, the fastener may be deflected away from your target.

- Disconnect the tool from the power source when the fastener jams in the tool.** While removing a jammed fastener, the tacker may be accidentally activated if it is plugged in.
- Do not use this stapler for fastening electrical cables.** It is not designed for electric cable installation and may damage the insulation of electric cables thereby causing electric shock or fire hazards.
- Always use both hands to operate the tool.** Your secondary hand should be used to press the back of the tool firmly down onto the surface to be fastened.
- Do not place the workpiece on any part of the body.** The workpiece may split causing the fastener to ricochet.
- Do not use fasteners near edge of material.** Be aware that the fastener may follow the grain of the wood, causing it to protrude unexpectedly from the side of the work material or deflect