

STEIN

STYLO MIRROR CABINET

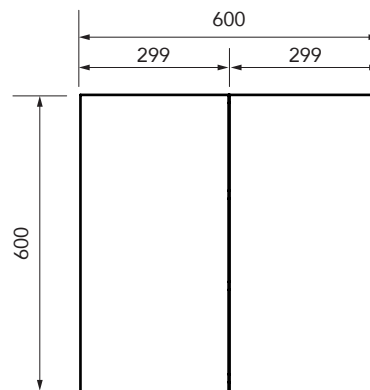
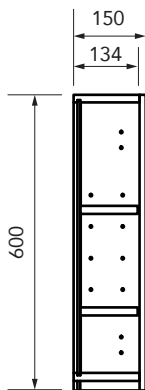
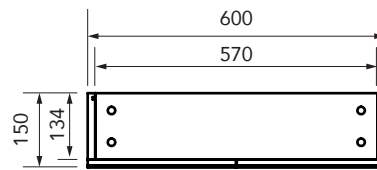
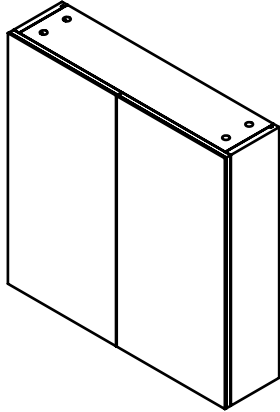

DESCRIPTION

CODE

Stylo Mirror Cabinet 600x600mm

0237821

Head Office: 3 Hynds Road, Greerton, Tauranga 3112

Email: info@stein.co.nz

Freephone: 0800 002 299 Phone: 07 928 9990

www.stein.nz

STEIN

STYLO MIRROR CABINET

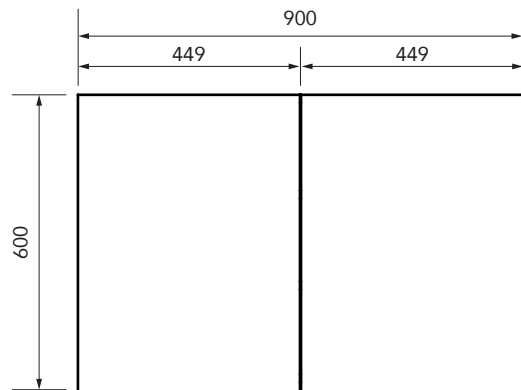
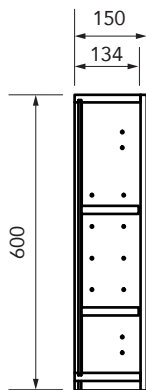
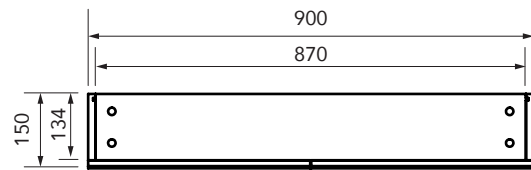
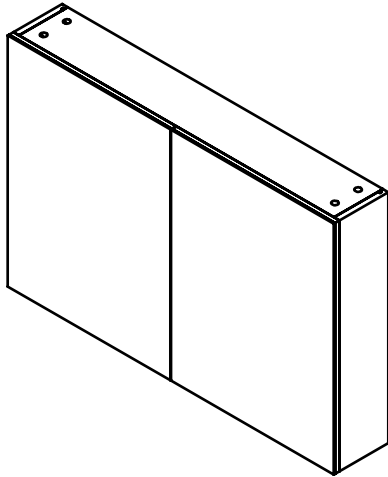

DESCRIPTION

CODE

Stylo Mirror Cabinet 900x600mm

0237829

Head Office: 3 Hynds Road, Greerton, Tauranga 3112

Email: info@stein.co.nz

Freephone: 0800 002 299 Phone: 07 928 9990

www.stein.nz

STEIN

STYLO MIRROR CABINET

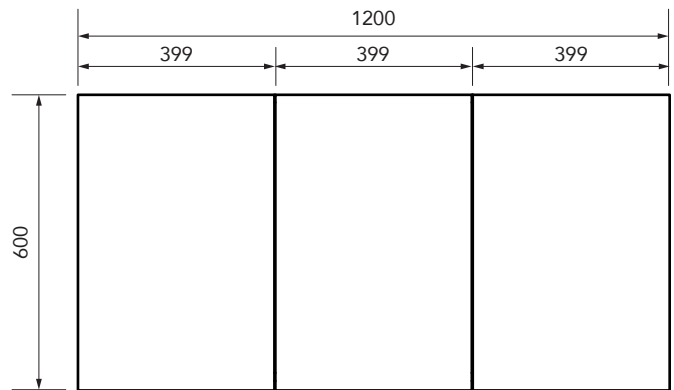
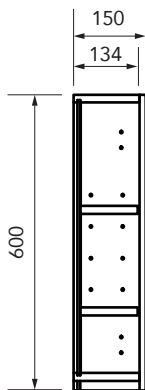
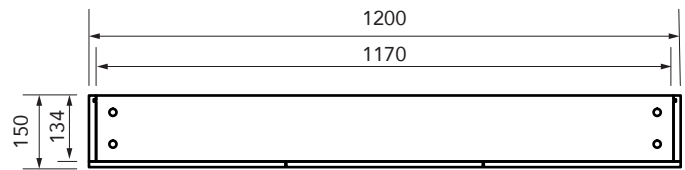
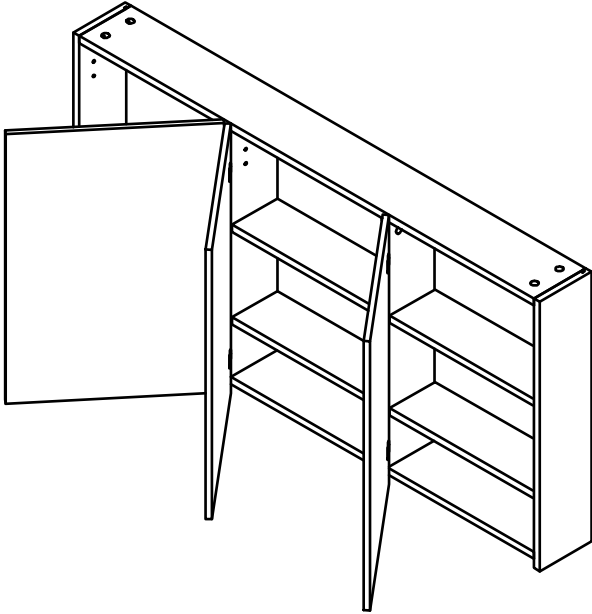

DESCRIPTION

CODE

Stylo Mirror Cabinet 1200x600mm

0237857

Head Office: 3 Hynds Road, Greerton, Tauranga 3112

Email: info@stein.co.nz

Freephone: 0800 002 299 Phone: 07 928 9990

www.stein.nz