

# ozito

## 3 IN 1 VACUUM BLOWER-MULCHER

### 2400W

### INSTRUCTION MANUAL

### SPECIFICATIONS

Voltage:	230-240V ~ 50Hz
Power:	2400W
No Load Speed:	10,000 - 15,000/min
Air Speed:	160 - 270km/h
Mulching Ratio:	10:1
Collection Bag:	40L
Weight:	3.4kg

ozito.com.au

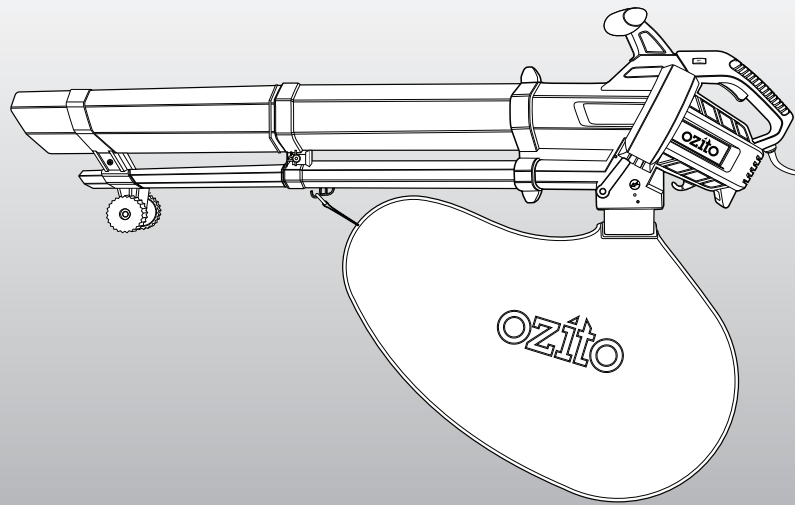

### WHAT'S IN THE BOX

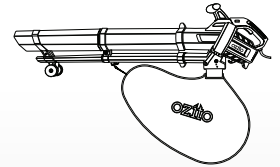

Blower Vac

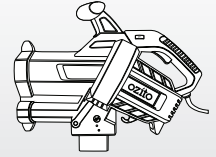

Housing & Handle

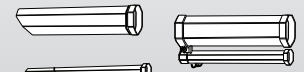

Blower Tubes

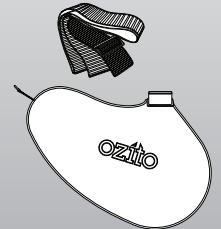

Collection Bag & Shoulder Strap

# 3 YEAR REPLACEMENT WARRANTY

BLV-2401

## WARRANTY

IN ORDER TO MAKE A CLAIM UNDER THIS WARRANTY YOU MUST RETURN THE PRODUCT TO YOUR NEAREST BUNNINGS WAREHOUSE WITH YOUR BUNNINGS REGISTER RECEIPT. PRIOR TO RETURNING YOUR PRODUCT FOR WARRANTY PLEASE TELEPHONE OUR CUSTOMER SERVICE HELPLINE:

**Australia 1800 069 486**

**New Zealand 0508 069 486**

TO ENSURE A SPEEDY RESPONSE PLEASE HAVE THE MODEL NUMBER AND DATE OF PURCHASE AVAILABLE. A CUSTOMER SERVICE REPRESENTATIVE WILL TAKE YOUR CALL AND ANSWER ANY QUESTIONS YOU MAY HAVE RELATING TO THE WARRANTY POLICY OR PROCEDURE.

The benefits provided under this warranty are in addition to other rights and remedies which are available to you at law.

Our goods come with guarantees that cannot be excluded at law. You are entitled to a replacement or refund for a major failure and for compensation for any other reasonably foreseeable loss or damage. You are also entitled to have the goods repaired or replaced if the goods fail to be of acceptable quality and the failure does not amount to a major failure.

Generally you will be responsible for all costs associated with a claim under this warranty, however, where you have suffered any additional direct loss as a result of a defective product you may be able to claim such expenses by contacting our customer service helpline above.

### 3 YEAR REPLACEMENT WARRANTY

Your product is guaranteed for a period of **36 months from the original date of purchase** and is intended for DIY (Do It Yourself) use only. If a product is defective it will be replaced in accordance with the terms of this warranty. Warranty excludes consumable parts, for example: Carbon brushes, blower tubes, collection bag and shoulder strap.

### WARNING

**The following actions will result in the warranty being void.**

- If the tool has been operated on a supply voltage other than that specified on the tool.
- If the tool shows signs of damage or defects caused by or resulting from abuse, accidents or alterations.
- Failure to perform maintenance as set out within the instruction manual.
- If the tool is disassembled or tampered with in any way.
- Professional, industrial or high frequency use.

# KNOW YOUR PRODUCT

## 3 IN 1 VACUUM BLOWER-MULCHER

- |                       |                       |
|-----------------------|-----------------------|
| 1 Nose Guide Wheels   | 6 Variable Speed Dial |
| 2 Lower Tubes         | 7 Main Handle         |
| 3 Upper Tube          | 8 Collection Bag      |
| 4 Secondary Handle    | 9 Mode Selector Lever |
| 5 Shoulder Strap Hook | 10 On/Off Trigger     |

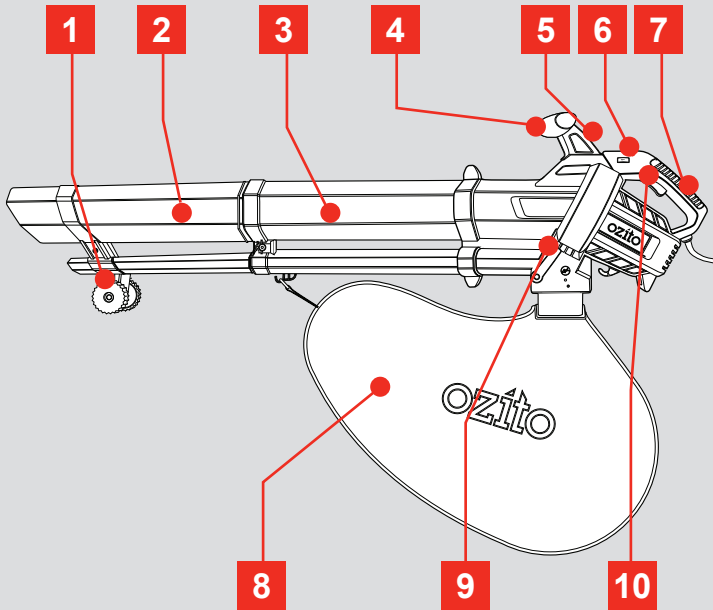

## ACCESSORIES:

- |                   |                                       |
|-------------------|---------------------------------------|
| 11 Shoulder Strap | 12 Assembly Screws x 3 (20,45 & 55mm) |
|-------------------|---------------------------------------|

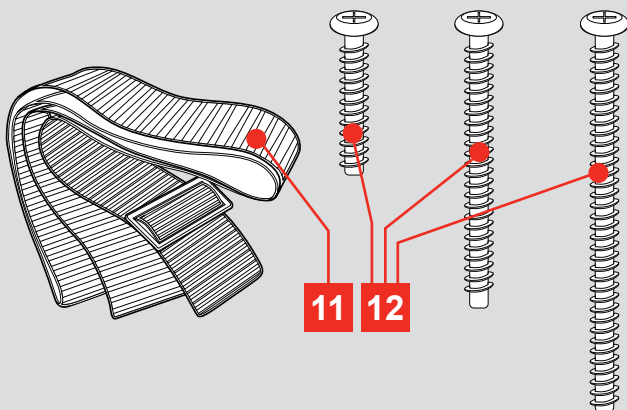

## ONLINE MANUAL

Scan this QR Code with your mobile device to take you to the online manual.



# SETUP & PREPARATION

## 1. ASSEMBLY

**WARNING!** ENSURE THE TOOL DISCONNECTED FROM THE POWER SUPPLY BEFORE PERFORMING ANY OF THE FOLLOWING OPERATIONS.

### Fitting the Secondary Handle

- 1 Insert the secondary handle so that it locks into place.

**NOTE:** If additional force is required, a rubber mallet may be used to gently tap the handle into place.

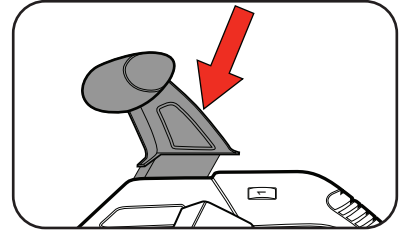

### Assembling the Tubes

- 1 Insert the small lower tube into the matching upper tube and push together until they are connected firmly.
- 2 Insert the large lower tube into the matching upper tube and push together until they are connected firmly.

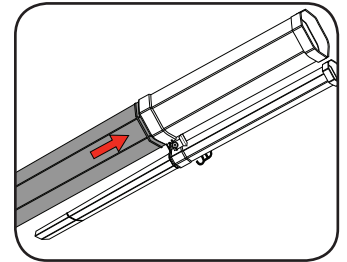
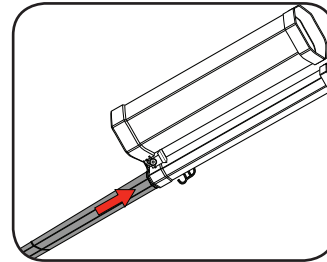

- 3 Secure the lower sections together with the supplied 45mm long assembly screw.
- 4 Slide the nose guide wheels over the lower tube and secure with the supplied 20mm long screw.

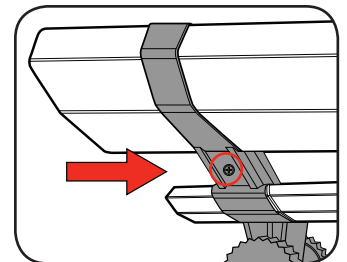
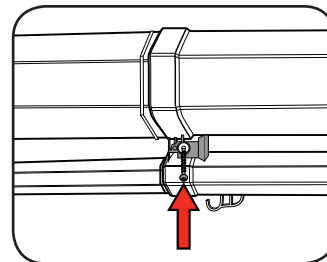

- 5 Slide the assembled tubes into the motor housing.
- 6 Secure the tubes with the supplied 55mm long screw

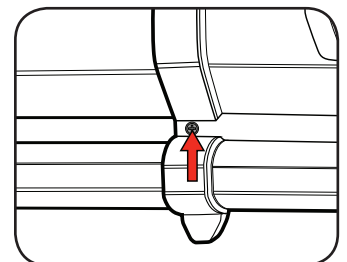
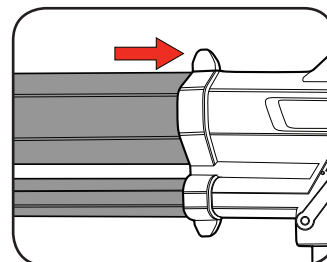

**3** YEAR REPLACEMENT WARRANTY

### Attaching the Collection Bag

- 1 Attach the plastic connector on the collection bag to the outlet in the housing.
- 2 Attach the clip on the collection bag to the hook underneath the upper tube.

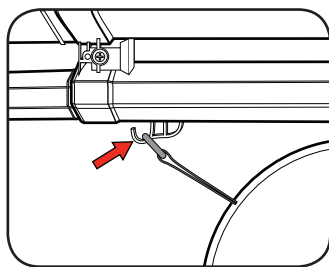
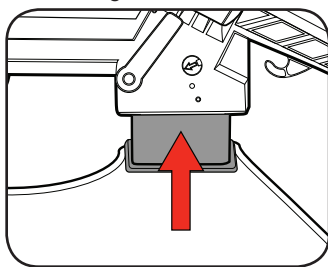

### Removing the Collection Bag

- 1 Simultaneously squeeze the two locating hooks on the plastic connector.
- 2 Pull the collection bag away from the housing.

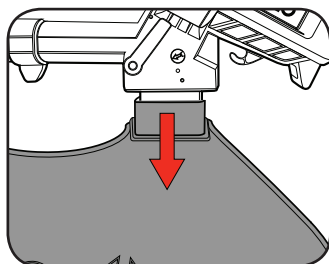
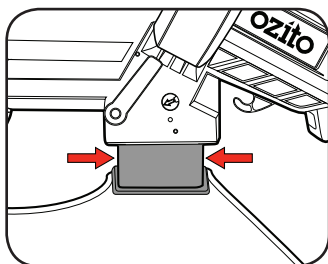

### Extension Cord Retainer

**NOTE:** To avoid the extension cord from detaching; always check that the cord is attached to the cord retainer before use.

- 1 Make a loop with the extension cord and push it through the square hole under the motor housing.
- 2 Place the end of the loop into the cord retainer.

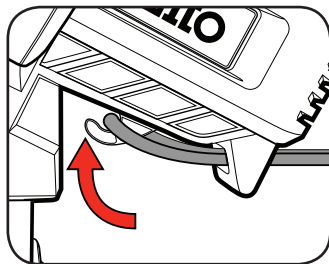
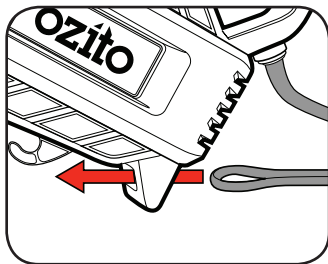

- 3 Connect the extension cord socket to the blower vac power cord.

### Fitting The Shoulder Strap

- 1 Undo the clip on the strap by pressing both sides inward.
- 2 Place the strap through the shoulder strap hook on the secondary handle.

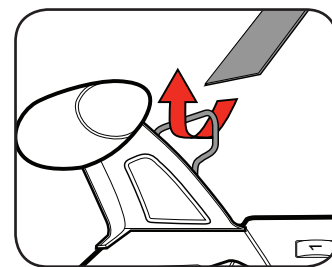
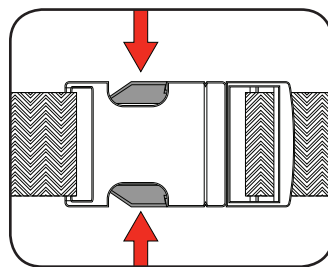

- 3 Close the clip on the strap to form a loop.

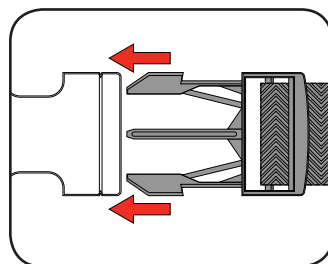

**NOTE:** To use the shoulder strap simply slide the strap over your shoulder so that some of the weight of the blower vac can be taken by your shoulder.

# OPERATION

## 2. CONTROLS

### On/Off Trigger

**WARNING!** THE POWER SUPPLY FOR THIS PRODUCT SHOULD BE PROTECTED BY A RESIDUAL CURRENT DEVICE RATED AT 30mA OR LESS.

1 To turn on squeeze the on/off trigger.

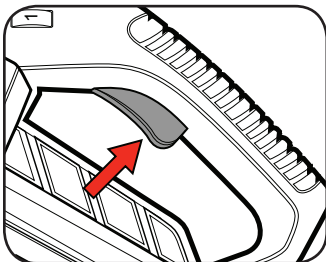

2 To turn off release the on/off trigger.

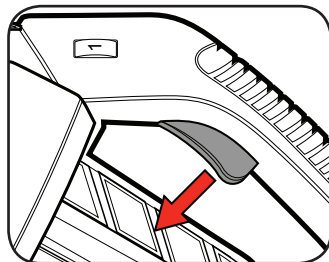

### Variable Speed Dial

1 To increase the air speed rotate the variable speed dial to a higher number.

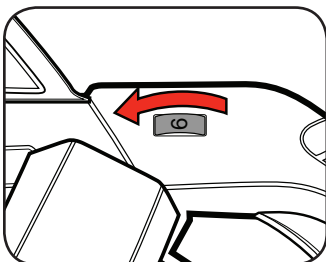

2 To lower the air speed rotate the variable speed dial to a lower number.

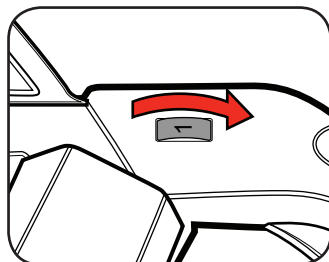

### Mode Selection Lever

1 To select the blower function move the lever down past the blower icon.

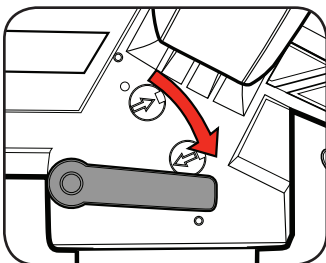

2 To select the vacuuming/mulching function move the lever up past the vacuuming icon.

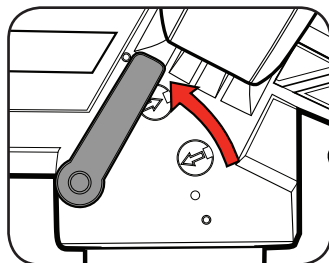

**IMPORTANT:** ALWAYS ENSURE THE COLLECTION BAG IS CORRECTLY ATTACHED AND BE AWARE OF WHAT IS BEING DRAWN UP INTO THE BLOWER VAC TUBE. THIS PRODUCT IS DESIGNED TO VACUUM GARDEN DEBRIS INCLUDING LEAVES, TWIGS AND GARDEN CUTTINGS.

## 3. USING THE BLOWER VAC

The 3 in 1 Vacuum Blower-Mulcher is ideal for blowing leaves, grass clippings and other debris from courtyards, driveways, decks and footpaths.

The mode selection lever allows a quick change from blowing to vacuum mode and is ideal for vacuuming leaves, grass clippings and other garden debris while shredding and reducing the volume collected for composting if desired. Always empty the collection bag after you have finished your job.

Hold firmly, squeeze the on/off trigger, point the vacuum tubes in front of you and move forward slowly resting the nose guide wheels on the ground. The nose guide wheels at the bottom end of the suction tube will help you to manoeuvre the suction tube on the ground.

**WARNING!** DO NOT ATTEMPT TO VACUUM STONES, GLASS OR OTHER SOLID OBJECTS, DOING SO COULD CAUSE MAJOR DAMAGE TO IMPELLOR AND COLLECTION BAG

**NOTE:** Be aware of other people and animals in the area where you are to be operating the machine.

**NOTE:** Avoid collisions with hard objects which could damage your machine.

**WARNING!** NEVER GATHER (BLOW) HOT, COMBUSTIBLE OR EXPLOSIVE MATERIAL INTO PILES.

**WARNING!** DO NOT OPERATE THE MACHINE WITH LONG LOOSE HAIR OR LOOSE FITTING JEWELLERY. TIE LONG LOOSE HAIR BACK AND REMOVE LOOSE FITTING JEWELLERY.

- Only use the machine in vacuum mode if the collection bag is undamaged and properly fitted.
- Do not pick up too many leaves in one go as this could clog the tube and the mulcher.
- To clear any blockages when poor suction occurs, follow the steps described in the section "Clearing Debris".
- Do not pick up hard or damp materials.

### Emptying The Collection Bag

For best results when vacuuming it is recommended to empty the collection bag after it becomes half full. Always empty the collection bag after you have finished your job.

**WARNING!** MAKE SURE THAT THE MACHINE IS SWITCHED OFF AND UNPLUGGED. WAIT UNTIL THE IMPELLOR HAS STOPPED BEFORE ATTEMPTING TO EMPTY OR REMOVE THE COLLECTION BAG.

1 Open the zip at the rear of the bag.

2 Be sure to close the zip prior to operating the blower vac.

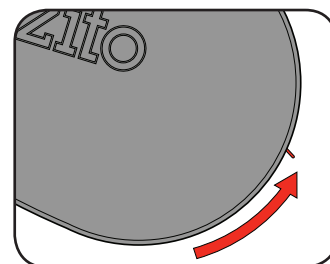
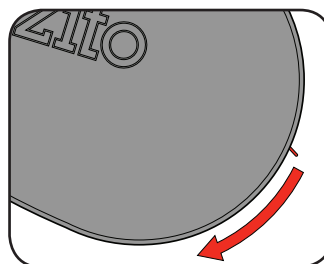

# MAINTENANCE



**WARNING!** ENSURE THE MACHINE IS DISCONNECTED FROM THE POWER SUPPLY BEFORE PERFORMING ANY OF THE FOLLOWING OPERATIONS.

## Clearing Debris

To access and clear any blockages when poor suction occurs, remove the vacuum tubes and collection bag.

1. Simultaneously squeeze the two locating hooks on the plastic connector and pull the collection bar away from the housing
2. Un-fasten the clip on the collection bag from the hook underneath the upper tube.

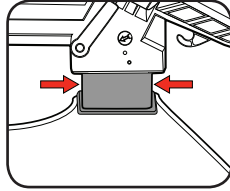

3. Remove the screw holding the tube assembly to the housing before pulling the assembled tubes from the motor housing.

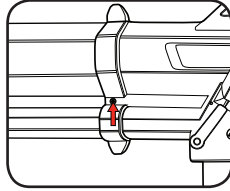

4. Remove any debris or build up within the suction/blower tubes the collection bag inlet, outlet and inlet in the motor housing.

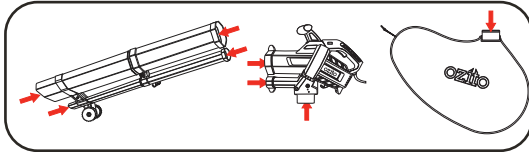

## Cleaning & Storage

- There are no user serviceable parts in the blower vac; if a fault is suspected or the supply cord requires replacement, return the blower vac to a power tool repairer.
- Keep air intake clean and air vents free from debris to avoid overheating the motor.
- If the enclosure of the blower vac requires cleaning do not use solvents but a moist soft cloth only. Never let any liquid get inside the blower vac; never immerse any part of the blower vac into liquid.
- After shaking out the catch bag, turn it inside out and thoroughly clean it in order to prevent mold and unpleasant odours from forming.
- Rub a bar of dry soap across the zipper teeth if the zipper becomes difficult to pull.
- If the blower vac vibrates abnormally, stop motor immediately. Abnormal vibration usually indicates a mechanical problem continued operation could lead to injury or damage.
- No lubrication is necessary as the motor is equipped with lifetime-lubrication bearings.
- Keep the ventilation vents of the blower vac clean at all times, if possible, prevent foreign matter from entering the vents.
- After each use, blow air through the blower vac housing to ensure it is free from all dust particles which may have built-up. Build up of dust particles may cause the blower vac to overheat and fail.
- When not in use, the blower vac should be stored in a dry, frost free location not within the reach of children.

*Note: Ozito Industries will not be responsible for any damage or injuries caused by the repair of the blower vac by an unauthorised person or by mishandling of the blower vac. This tool is designed for DIY use - use in commercial or industrial environments will void the warranty.*

# TROUBLESHOOTING

Problem	Cause	Remedy
Poor Suction	Collection bag full	Empty the collection bag
	Clogged air tubes	Remove any debris or built up within the upper and lower tubes.
	Clogged collection bag connector	Remove the collection bag, remove build up of debris from connector & outlet in the housing.

# DESCRIPTION OF SYMBOLS

	Double insulated	V	Voltage
	Regulator compliance mark	Hz	Hertz
n <sub>0</sub>	No load speed	W	Wattage
/min	Revolutions or reciprocation per minute		Warning
~	Alternating current		Read operator's manual
m <sup>3</sup>	Metres cubed		
	Wear eye protection		Remove plug from mains before cleaning or maintenance
	Do not use in wet weather		Disconnect the mains plug if the cord becomes damaged or entangled
	Keep by standers away		
	Keep hands out of the openings while the tool is running		
	Be aware of people around you and do not direct towards them		
	Sound power level		

# SPARE PARTS

Collection Bag (support not included) **BVBA-002**

Support, Collection Bag

**SPBLV2401-26**

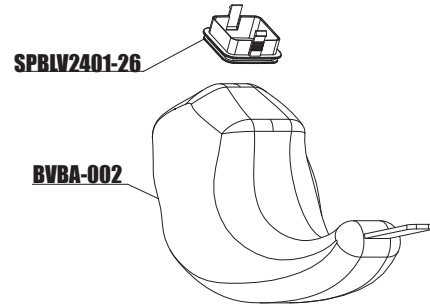

Spare parts can be ordered from the Special Orders Desk at your local Bunnings Warehouse.

For further information, or any parts not listed here, visit

[www.ozito.com.au](http://www.ozito.com.au) or contact Ozito Customer Service:

Australia 1800 069 486

New Zealand 0508 069 486

E-mail: [enquires@ozito.com.au](mailto:enquires@ozito.com.au)

# CARING FOR THE ENVIRONMENT



Power tools that are no longer usable should not be disposed of with household waste but in an environmentally friendly way. Please recycle where facilities exist. Check with your local council authority for recycling advice.



Recycling packaging reduces the need for landfill and raw materials. Reuse of recycled material decreases pollution in the environment. Please recycle packaging where facilities exist. Check with your local council authority for recycling advice.





# ELECTRICAL SAFETY



**WARNING!** When using mains-powered tools, basic safety precautions, including the following, should always be followed to reduce risk of fire, electric shock, personal injury and material damage.

Read the whole manual carefully and make sure you know how to switch the tool off in an emergency, before operating the tool.

Save these instructions and other documents supplied with this tool for future reference.

This tool has been designed for 230V and 240V only. Always check that the power supply corresponds to the voltage on the rating plate.

**Note:** The supply of 230V and 240V on Ozito tools are interchangeable for Australia and New Zealand.

**This tool is double insulated; therefore no earth wire is required.**



**Note:** Double insulation does not take the place of normal safety precautions when operating this tool. The insulation system is for added protection against injury resulting from a possible electrical insulation failure within the tool.

## Using an Extension Lead

Always use an approved extension lead suitable for the power input of this tool. Before use, inspect the extension lead for signs of damage, wear and ageing. Replace the extension lead if damaged or defective. When using an extension lead on a reel, always unwind the lead completely. Use of an extension lead not suitable for the power input of the tool or which is damaged or defective may result in a risk of fire and electric shock.

The power supply for this product should be protected by a residual current device (rated at 30mA or less). A residual current device reduces the risk of electric shock.



# GENERAL POWER TOOL SAFETY WARNINGS

**WARNING!** Read all safety warnings and all instructions. Failure to follow the warnings and instructions may result in electric shock, fire and/or serious injury.

Save all warnings and instructions for future reference. The term "power tool" in the warnings refers to your mains-operated (corded) power tool or battery-operated (cordless) power tool.

## 1. Work area safety

- Keep work area clean and well lit. Cluttered or dark areas invite accidents.
- Do not operate power tools in explosive atmospheres, such as in the presence of flammable liquids, gases or dust. Power tools create sparks which may ignite the dust or fumes.
- Keep children and bystanders away while operating a power tool. Distractions can cause you to lose control.

## 2. Electrical safety

- Power tool plugs must match the outlet. Never modify the plug in any way. Do not use any adapter plugs with earthed (grounded) power tools. Unmodified plugs and matching outlets will reduce risk of electric shock.
- Avoid body contact with earthed or grounded surfaces, such as pipes, radiators, ranges and refrigerators. There is an increased risk of electric shock if your body is earthed or grounded.
- Do not expose power tools to rain or wet conditions. Water entering a power tool will increase the risk of electric shock.
- Do not abuse the cord. Never use the cord for carrying, pulling or unplugging the power tool. Keep cord away from heat, oil, sharp edges or moving parts. Damaged or entangled cords increase the risk of electric shock.
- When operating a power tool outdoors, use an extension cord suitable for outdoor use. Use of a cord suitable for outdoor use reduces the risk of electric shock.
- If operating a power tool in a damp location is unavoidable, use a residual current device (RCD) protected supply. Use of an RCD reduces the risk of electric shock.

## 3. Personal safety

- Stay alert, watch what you are doing and use common sense when operating a power tool. Do not use a power tool while you are tired or under the influence of drugs, alcohol or medication. A moment of inattention while operating power tools may result in serious personal injury.
- Use personal protective equipment. Always wear eye protection. Protective equipment such as dust mask, non-skid safety shoes, hard hat, or hearing protection used for appropriate conditions will reduce personal injuries.
- Prevent unintentional starting. Ensure the switch is in the off-position before connecting to power source and/or battery pack, picking up or carrying the tool. Carrying power tools with your finger on the switch or energising power tools that have the switch on invites accidents.
- Remove any adjusting key or wrench before turning the power tool on. A wrench or a key left attached to a rotating part of the power tool may result in personal injury.

- Do not overreach. Keep proper footing and balance at all times. This enables better control of the power tool in unexpected situations.
  - Dress properly. Do not wear loose clothing or jewellery. Keep your hair, clothing and gloves away from moving parts. Loose clothes, jewellery or long hair can be caught in moving parts.
  - If devices are provided for the connection of dust extraction and collection facilities, ensure these are connected and properly used. Use of dust collection can reduce dust-related hazards.
  - Do not let familiarity gained from frequent use of tools allow you to become complacent and ignore tool safety principles. A careless action can cause severe injury within a fraction of a second.
- ## 4. Power tool use and care
- Do not force the power tool. Use the correct power tool for your application. The correct power tool will do the job better and safer at the rate for which it was designed.
  - Do not use the power tool if the switch does not turn it on and off. Any power tool that cannot be controlled with the switch is dangerous and must be repaired.
  - Disconnect the plug from the power source and/or the battery pack from the power tool before making any adjustments, changing accessories, or storing power tools. Such preventive safety measures reduce the risk of starting the power tool accidentally.
  - Store idle power tools out of the reach of children and do not allow persons unfamiliar with the power tool or these instructions to operate the power tool. Power tools are dangerous in the hands of untrained users.
  - Maintain power tools. Check for misalignment or binding of moving parts, breakage of parts and any other condition that may affect the power tool's operation. If damaged, have the power tool repaired before use. Many accidents are caused by poorly maintained power tools.
  - Keep cutting tools sharp and clean. Properly maintained cutting tools with sharp cutting edges are less likely to bind and are easier to control.
  - Use the power tool, accessories and tool bits etc. in accordance with these instructions, taking into account the working conditions and the work to be performed. Use of the power tool for operations different from those intended could result in a hazardous situation.
  - Keep handles and grasping surfaces dry, clean and free from oil and grease. Slippery handles and grasping surfaces do not allow for safe handling and control of the tool in unexpected situations.
- ## 5. Service
- Have your power tool serviced by a qualified repair person using only identical replacement parts. This will ensure that the safety of the power tool is maintained.
  - If the supply cord is damaged, it must be replaced by the manufacturer, its service agent or similarly qualified persons in order to avoid a hazard.



# ELECTRIC BLOWER VAC SAFETY WARNINGS

Always wear adequate protective clothing when operating the tool to avoid injuries to face, eyes, hand, feet, head or hearing. Use safety glasses or a face shield, high boots or sturdy shoes, long trousers, work gloves, a hard hat and ear defenders.

Do not start the tool when it is upside down or when it is not in the operating position.

Switch the motor off and remove the plug when the tool is not being used, left unattended, being cleaned, being moved from one place to another or when the extension cord is entangled or damaged.

Do not operate the tool near people, especially children or pets. Turn it off if they get too close. Maintain a safe distance of at least 5m from other people when using the tool.

Never direct the blower direction nozzle towards bystanders or pets. Never blow debris in the direction of bystanders or pets. The operator is responsible for accidents or hazards occurring to other people or their property.

Do not handle the plug or the tool with wet hands and do not use the tool in the rain.

Use only outdoor rated extension leads that are so marked. Keep the extension cord away from heat, oil and sharp edges.

Ensure that the extension lead is secured in a manner that prevents it from disconnecting from the plug whilst in use.

Keep all the air intakes and the blower tube free of dust, lint, hair and other material that may cause a reduction in air flow.

Keep a balanced and stable stance while using the tool. Do not switch on the tool in enclosed or poorly ventilated spaces or in the presence of inflammable and/or explosive substances such as liquids, gasses and powders.

Do not get distracted and always concentrate on what you are doing. Use common sense. Never operate the tool when you are tired, sick or under the influence of alcohol or other drugs.

Do not operate this appliance with long loose hair or loose fitting jewellery. Tie long loose hair back and remove loose fitting jewellery.

Only operate the tool during broad daylight or with adequate artificial light.

This appliance is not intended for use by persons (including children) with reduced physical, sensory or mental capabilities, or lack of experience and knowledge, unless they have been given supervision or instruction concerning use of the appliance by a person responsible for their safety.

Young children should be supervised to ensure that they do not play with the appliance.

Only use the tool according to the instructions given in this manual.

Check regularly that the screws are tight.

Do not allow the blower vac to pick up any burning or smouldering materials like ashes, cigarette butts etc.

Do not attempt to pick up breakable objects like glass, plastics, china etc.

Do not use in vacuum operation without the collection bag fitted.

Do not use in the rain or leave outdoors while raining.

## 1) Training

- Read the instructions carefully. Be familiar with the controls and the proper use of the appliance.

- Never allow children, persons with reduced physical, sensory or mental capabilities or lack of experience and knowledge or people unfamiliar with these instructions to use the machine, local regulations may restrict the age of the operator
- Never allow people unfamiliar with these instructions to use the appliance. Local regulations may restrict the age of the operator.
- Never operate the appliance while people, especially children, or pets are nearby.
- The operator or user is responsible for accidents or hazards occurring to other people or their property.

## 2) Preparation

- While operating the appliance, always wear substantial footwear and long trousers.
- Do not wear loose clothing or jewellery that can be drawn into the air inlet. Keep long hair away from the air inlets.
- Wear protective goggles while operating
- To prevent dust irritation the wearing of a face mask is recommended
- Before using, check the supply and extension cord for signs of damage and aging.
- Do not use the appliance if the cord is damaged or worn.
- Never operate the appliance with defective guards or shields, or without safety devices, for example debris collector in place.
- Only use a weather proof extension cord fitted with a coupler according to IEC 60320-2-3.

## 3) Operation

- Always direct the cord to the rear away from the appliance.
- If a cord becomes damaged during use, disconnect the supply cord from the mains immediately. DO NOT TOUCH THE CORD BEFORE DISCONNECTING THE SUPPLY.
- Do not carry the appliance by the cord.
- Disconnect the appliance from the mains supply
  - whenever you leave the machine;
  - before clearing a blockage;
  - before checking, cleaning or working on the appliance;
  - if the appliance starts to vibrate abnormally.
- Operate the appliance only in daylight or in good artificial light.
- Do not overreach and keep your balance at all times.
- Always be sure of your footing on slopes.
- Walk, never run.
- Keep all cooling air inlets clear of debris.
- Never blow debris in the direction of bystanders.

## 4) Maintenance and storage

- Keep all nuts, bolts and screws tight to be sure the appliance is in safe working condition.
- Check the debris collector frequently for wear or deterioration.
- Replace worn or damaged parts.
- Use only genuine replacement parts and accessories
- Store the appliance only in a dry place.