

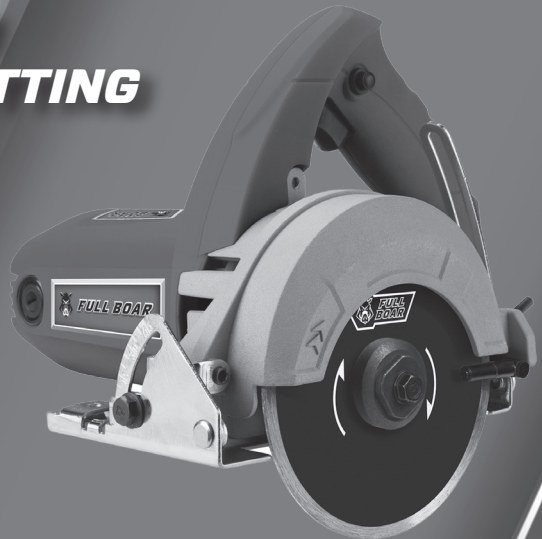



# 125MM TILE CUTTER

- 950W MOTOR
- VARIABLE CUTTING DEPTHS
- BEVEL CUTS



## INSTRUCTION MANUAL

 **WARNING:** Read all safety warnings and all instructions. Failure to follow the warnings and instructions may result in electric shock, fire and/or serious injury. Save all warnings and instructions for future reference.

# SPECIFICATIONS - MODEL NO. FBWDTC-17125

<b>Mains voltage:</b>	220-240V ~ 50Hz
<b>Input power:</b>	950W
<b>No load speed:</b>	≤12,000 min <sup>-1</sup>
<b>Blade:</b>	Ø125 x Ø20 mm
<b>Threaded spindle:</b>	M6
<b>Bevel cuts:</b>	0 – 45°
<b>Cutting depth max.:</b>	37 mm
<b>IP rating:</b>	IPX0
<b>Weight (tool only):</b>	2.9 kg

## KNOW YOUR PRODUCT

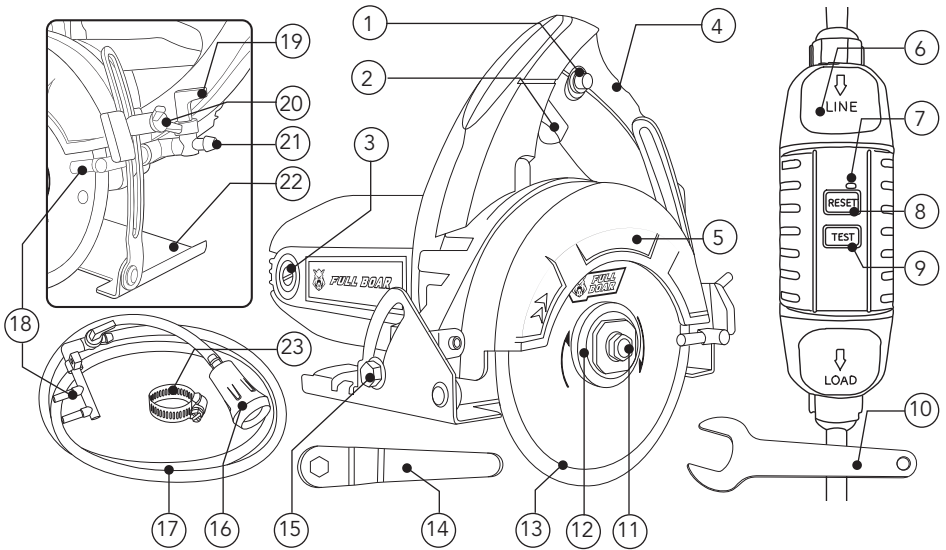

- |                                  |                         |                            |
|----------------------------------|-------------------------|----------------------------|
| 1. Lock-off button               | 9. RCD Test             | 17. Water tube             |
| 2. On/off trigger                | 10. Spanner             | 18. Wet cutting attachment |
| 3. Carbon brush cover            | 11. Blade bolt          | 19. Water valve            |
| 4. Handle                        | 12. Outer flange        | 20. Wing nut               |
| 5. Safety guard                  | 13. Blade               | 21. Water inlet            |
| 6. Residual-Current Device (RCD) | 14. Wrench              | 22. Base plate             |
| 7. LED                           | 15. Bevel bolt          | 23. Hose clamp             |
| 8. RCD Reset                     | 16. Water tap connector |                            |

## TABLE OF CONTENTS

SPECIFICATIONS.....	Page 02
KNOW YOUR PRODUCT.....	Page 02
INTRODUCTION.....	Page 04
SAFETY INSTRUCTIONS.....	Page 04
SET-UP & PREPARATION.....	Page 09
OPERATION.....	Page 12
MAINTENANCE.....	Page 14
DESCRIPTION OF SYMBOLS.....	Page 15
CONTENTS.....	Page 15
WARRANTY.....	Page 16

## INTRODUCTION

Congratulations on purchasing a Full Boar 125mm Tile Cutter. The Full Boar Tile Cutter FBWDTC-17125 is designed for cutting tiles, pavers, bricks and concrete with the use of water. It should never be used for the cutting of wood or metal.

1 x Continuous rim diamond blade supplied for wet cutting only. Read and understand the Owner's Manual before operating the Tile Cutter. Failure to do so could result in personal injury or equipment damage.

## SAFETY INSTRUCTIONS



**WARNING!** When using mains-powered equipment, basic safety precautions, including the following, should always be followed to reduce risk of fire, electric shock, personal injury and material damage.

Read and understand the manual prior to operating this tool.

Save these instructions and other documents supplied with this tool for future reference.

The manufacturer cannot accept any liability for damage or accidents which arise due to a failure to follow these instructions and the safety information.

## ELECTRICAL SAFETY

The electric motor has been designed for 220V and 240V only. Always check that the power supply corresponds to the voltage on the rating plate.

**Note:** The supply of 220V and 240V is interchangeable for Australia and New Zealand.



This tool is double insulated, therefore no earth wire is required.

If the supply cord of this power tool is damaged, it must be replaced by a specially prepared cord available through the service organization.

**Note:** Double insulation does not take the place of normal safety precautions when operating this tool. The insulation system is for added protection against injury resulting from a possible electrical insulation failure within the tool.

### Using an Extension Lead

Always use an approved heavy duty extension lead suitable for the power input of this tool. Before use, inspect the extension lead for signs of damage, wear and ageing. Replace the extension lead if damaged or defective. When using an extension lead on a reel, always unwind the lead completely. Use of an extension lead not suitable for the power input of the tool or which is damaged or defective may result in a risk of fire and electric shock.

# GENERAL POWER TOOL SAFETY WARNINGS



**WARNING!** Read all safety warnings and instructions. Failure to follow all instructions listed below may result in electric shock, fire and/or serious injury. The term "Power Tool" in all of the warnings listed below refers to your mains operated (corded) power tool or battery operated (cordless) power tool.

## SAVE THESE INSTRUCTIONS

### 1. Work area safety

- a. **Keep work area clean and well lit.** Cluttered or dark areas invite accidents.
- b. **Do not operate power tools in explosive atmospheres, such as in the presence of flammable liquids, gases or dust.** Power tools create sparks which may ignite the dust or fumes.
- c. **Keep children and bystanders away while operating a power tool.** Distractions can cause you to lose control.

### 2. Electrical safety

- a. **Power tool plugs must match the outlet. Never modify the plug in any way. Do not use any adapter plugs with earthed (grounded) power tools.** Unmodified plugs and matching outlets will reduce risk of electric shock.
- b. **Avoid body contact with earthed or grounded surfaces, such as pipes, radiators, ranges and refrigerators.** There is an increased risk of electric shock if your body is earthed or grounded.
- c. **Do not expose power tools to rain or wet conditions.** Water entering a power tool will increase the risk of electric shock.
- d. **Do not abuse the cord. Never use the cord for carrying, pulling or unplugging the power tool. Keep cord away from heat, oil, sharp edges or moving parts.** Damaged or entangled cords increase the risk of electric shock.
- e. **When operating a power tool outdoors, use an extension cord suitable for outdoor use.** Use of a cord suitable for outdoor use reduces the risk of electric shock.
- f. **If operating a power tool in a damp location is unavoidable, use a residual current device (RCD) protected supply.** Use of an RCD reduces the risk of electric shock.

### 3. Personal safety

- a. **Stay alert, watch what you are doing and use common sense when operating a power tool. Do not use a power tool while you are tired or under the influence of drugs, alcohol or medication.** A moment of inattention while operating power tools may result in serious personal injury.
- b. **Use personal protective equipment. Always wear eye protection.** Protective equipment such as dust mask, non-skid safety shoes, hard hat, or hearing protection used for appropriate conditions will reduce personal injuries.
- c. **Prevent unintentional starting. Ensure the switch is in the off-position before connecting to power source and/or battery pack, picking up or carrying the tool.** Carrying power tools with your finger on the switch or energising power tools that have the switch on invites accidents.

## GENERAL POWER TOOL SAFETY WARNINGS (cont.)

- d. **Remove any adjusting key or wrench before turning the power tool on.** A wrench or a key left attached to a rotating part of the power tool may result in personal injury.
- e. **Do not overreach. Keep proper footing and balance at all times.** This enables better control of the power tool in unexpected situations.
- f. **Dress properly. Do not wear loose clothing or jewellery. Keep your hair, clothing and gloves away from moving parts.** Loose clothes, jewellery or long hair can be caught in moving parts.
- g. **If devices are provided for the connection of dust extraction and collection facilities, ensure these are connected and properly used.** Use of dust collection can reduce dust-related hazards.
- h. **Do not let familiarity gained from frequent use of tools allow you to become complacent and ignore tool safety principles.** A careless action can cause severe injury within a fraction of a second.

### 4. Power tool use and care

- a. **Do not force the power tool. Use the correct power tool for your application.** The correct power tool will do the job better and safer at the rate for which it was designed.
- b. **Do not use the power tool if the switch does not turn it on and off.** Any power tool that cannot be controlled with the switch is dangerous and must be repaired.
- c. **Disconnect the plug from the power source and/or the battery pack from the power tool before making any adjustments, changing accessories, or storing power tools.** Such preventive safety measures reduce the risk of starting the power tool accidentally.
- d. **Store idle power tools out of the reach of children and do not allow persons unfamiliar with the power tool or these instructions to operate the power tool.** Power tools are dangerous in the hands of untrained users.
- e. **Maintain power tools. Check for misalignment or binding of moving parts, breakage of parts and any other condition that may affect the power tool's operation. If damaged, have the power tool repaired before use.** Many accidents are caused by poorly maintained power tools.
- f. **Keep cutting tools sharp and clean.** Properly maintained cutting tools with sharp cutting edges are less likely to bind and are easier to control.
- g. **Use the power tool, accessories and tool bits etc. in accordance with these instructions, taking into account the working conditions and the work to be performed.** Use of the power tool for operations different from those intended could result in a hazardous situation.
- h. **Keep handles and grasping surfaces dry, clean and free from oil and grease.** Slippery handles and grasping surfaces do not allow for safe handling and control of the tool in unexpected situations.

### 5. Service

- a. **Have your power tool serviced by a qualified repair person using only identical replacement parts.** This will ensure that the safety of the power tool is maintained.
- b. **If the supply cord is damaged,** it must be replaced by an electrician or a power tool repairer in order to avoid a hazard.

## TILE CUTTER SAFETY WARNINGS

- a) **The guard provided with the tool must be securely attached to the power tool and positioned for maximum safety, so the least amount of wheel is exposed towards the operator. Position yourself and bystanders away from the plane of the rotating wheel.**  
The guard helps to protect operator from broken wheel fragments and accidental contact with wheel.
- b) **Use only bonded reinforced or diamond cut-off wheels for your power tool.** Just because an accessory can be attached to your power tool, it does not assure safe operation.
- c) **The rated speed of the accessory must be at least equal to the maximum speed marked on the power tool.** Accessories running faster than their rated speed can break and fly apart.
- d) **Wheels must be used only for recommended applications. For example: do not grind with the side of cut-off wheel.** Abrasive cut-off wheels are intended for peripheral grinding, side forces applied to these wheels may cause them to shatter.
- e) **Always use undamaged wheel flanges that are of correct diameter for your selected wheel.** Proper wheel flanges support the wheel thus reducing the possibility of wheel breakage.
- f) **Do not use worn down reinforced wheels from larger power tools.** Wheels intended for a larger power tool are not suitable for the higher speed of a smaller tool and may burst.  
NOTE The above warning does not apply for tools only designated to be used with diamond wheels.
- g) **The outside diameter and the thickness of your accessory must be within the capacity rating of your power tool. Incorrectly sized accessories cannot be adequately guarded or controlled.**
- h) **The arbour size of wheels and flanges must properly fit the spindle of the power tool.**  
Wheels and flanges with arbour holes that do not match the mounting hardware of the power tool will run out of balance, vibrate excessively and may cause loss of control.
- i) **Do not use damaged wheels. Before each use, inspect the wheels for chips and cracks. If power tool or wheel is dropped, inspect for damage or install an undamaged wheel. After inspecting and installing the wheel, position yourself and bystanders away from the plane of the rotating wheel and run the power tool at maximum no load speed for one minute. Damaged wheels will normally break apart during this test time.**
- j) **Wear personal protective equipment. Depending on application, use face shield, safety goggles or safety glasses. As appropriate, wear dust mask, hearing protectors, gloves and shop apron capable of stopping small abrasive or workpiece fragments.** The eye protection must be capable of stopping flying debris generated by various operations. The dust mask or respirator must be capable of filtering particle generated by your operation. Prolonged exposure to high intensity noise may cause hearing loss.
- k) **Keep bystanders a safe distance away from work area. Anyone entering the work area must wear personal protective equipment.** Fragments of workpiece or of a broken wheel may fly away and cause injury beyond immediate area of operation.
- l) **Hold the power tool by insulated gripping surfaces only, when performing an operation where the cutting accessory may contact hidden wiring or its own cord.** Cutting accessory contacting a "live" wire may make exposed metal parts of the power tool "live" and could give the operator an electric shock.
- m) **Position the cord clear of the spinning accessory.** If you lose control, the cord may be cut or snagged and your hand or arm may be pulled into the spinning wheel.
- n) **Never lay the power tool down until the accessory has come to a complete stop.** The spinning wheel may grab the surface and pull the power tool out of your control.
- o) **Do not run the power tool while carrying it at your side.** Accidental contact with the spinning accessory could snag your clothing, pulling the accessory into your body.

## TILE CUTTER SAFETY WARNINGS (cont.)

- p) **Regularly clean the power tool's air vents.** The motor's fan will draw the dust inside the housing and excessive accumulation of powdered metal may cause electrical hazards.
- q) **Do not operate the power tool near flammable materials.** Sparks could ignite these materials.

### **Kickback and related warnings**

Kickback is a sudden reaction to a pinched or snagged rotating wheel. Pinching or snagging causes rapid stalling of the rotating wheel which in turn causes the uncontrolled power tool to be forced in the direction opposite of the wheel's rotation at the point of the binding. For example, if an abrasive wheel is snagged or pinched by the workpiece, the edge of the wheel that is entering into the pinch point can dig into the surface of the material causing the wheel to climb out or kick out. The wheel may either jump toward or away from the operator, depending on direction of the wheel's movement at the point of pinching. Abrasive wheels may also break under these conditions.

Kickback is the result of power tool misuse and/or incorrect operating procedures or conditions and can be avoided by taking proper precautions as given below.

- a) **Maintain a firm grip on the power tool and position your body and arm to allow you to resist kickback forces. Always use auxiliary handle, if provided, for maximum control over kickback or torque reaction during start-up.** The operator can control torque reactions or kickback forces, if proper precautions are taken.
- b) **Never place your hand near the rotating accessory.** Accessory may kickback over your hand.
- c) **Do not position your body in line with the rotating wheel.** Kickback will propel the tool in direction opposite to the wheel's movement at the point of snagging.
- d) **Use special care when working corners, sharp edges etc. Avoid bouncing and snagging the accessory.** Corners, sharp edges or bouncing have a tendency to snag the rotating accessory and cause loss of control or kickback.
- e) **Do not attach a saw chain, woodcarving blade, segmented diamond wheel with a peripheral gap greater than 10 mm or toothed saw blade.** Such blades create frequent kickback and loss of control.
- f) **Do not "jam" the wheel or apply excessive pressure. Do not attempt to make an excessive depth of cut.** Overstressing the wheel increases the loading and susceptibility to twisting or binding of the wheel in the cut and the possibility of kickback or wheel breakage.
- g) **When wheel is binding or when interrupting a cut for any reason, switch off the power tool and hold the power tool motionless until the wheel comes to a complete stop. Never attempt to remove the wheel from the cut while the wheel is in motion otherwise kickback may occur.** Investigate and take corrective action to eliminate the cause of wheel binding.
- h) **Do not restart the cutting operation in the workpiece. Let the wheel reach full speed and carefully re-enter the cut.** The wheel may bind, walk up or kickback if the power tool is restarted in the workpiece.
- i) **Support panels or any oversized workpiece to minimize the risk of wheel pinching and kickback.** Large workpieces tend to sag under their own weight. Supports must be placed under the workpiece near the line of cut and near the edge of the workpiece on both sides of the wheel.
- j) **Use extra caution when making a "pocket cut" into existing walls or other blind areas.** The protruding wheel may cut gas or water pipes, electrical wiring or objects that can cause kickback.



## SET-UP & PREPARATION



**WARNING!** Ensure the tool is switched off and disconnected from the power supply and completely stopped before performing any of the following operations.

### Fitting & removing the blade (13)



**WARNING!** When mounting and replacing blade (13), it's recommended to wear protective gloves.

**WARNING!** Make sure that directional arrow on the blade (13) coincides with the rotational direction of the safety guard (5).

**WARNING!** Only use a blade with diameter and bore size as specified in this manual. Failure to comply can result to serious injury and damage to the tool.

1. Using the supplied spanner (10), hold the outer flange (12) while loosening the blade bolt (11) with supplied wrench (14), turning clockwise (left-hand thread) (fig. 1).
2. Remove blade bolt (11), outer flange (12) and blade (13) if installed.

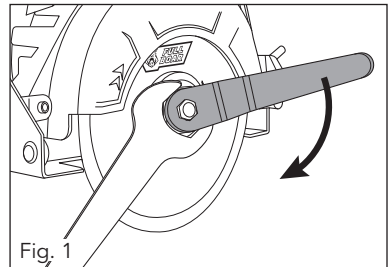

3. With the mounting flange sitting on the spindle, place the blade (13) onto the mounting flange securely in the proper direction of rotation (fig. 2).
4. Fit the outer flange (12) and blade bolt (11). Hold the outer flange (12) with the spanner (10) and firmly tighten the blade bolt (11) anti-clockwise with wrench (14).

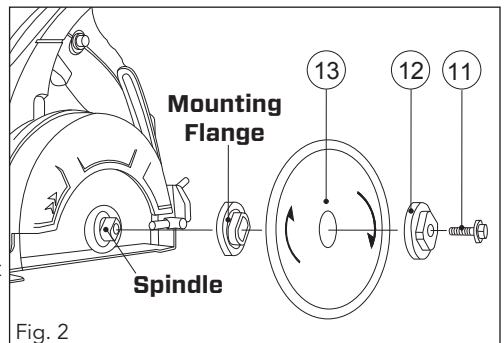

**WARNING!** Do not use a abrasive cut-off or bonded reinforced wheel.



**IMPORTANT!** The included continuous rim diamond blade is designed for wet cutting only.

## SET-UP & PREPARATION (cont.)

### Installing the wet cutting attachment

1. Loosen the wing nut (20) and move the base plate (22) down.
2. Attach the wet cutting attachment (18) to the tool using a screwdriver (not provided) (fig. 3).

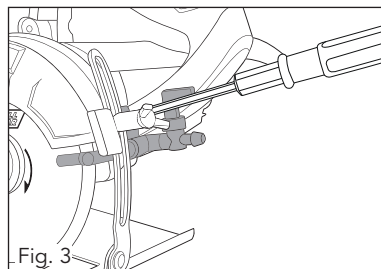

3. Push fit to install the water tube (17) to the water inlet (21) (fig. 4).

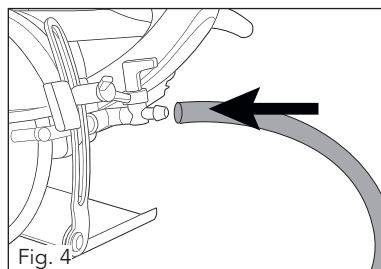

**WARNING!** Make sure that the included continuous rim diamond blade is cooled with water during the complete cutting process.

4. Attach the water tap connector (16) to a garden hose (not included); connected to tap for water mains pressure. Push in fully and secure with provided hose clamp (23) (fig. 5).

Adjust the amount of water flow by simply adjusting the water valve (19) and the tap.

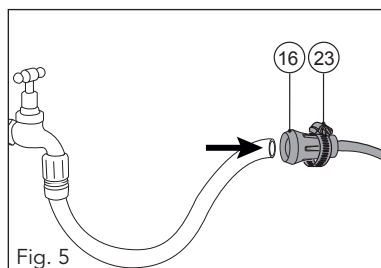

**IMPORTANT!** The included continuous rim diamond blade is designed for wet cutting only.

## SET-UP & PREPARATION (cont.)

### Depth of cut adjustment

1. To adjust the blade (13) to the desired cutting depth, loosen the wing nut (20) and move the base plate (22) up or down (fig. 6).

**Note:** For best results, make sure to adjust the depth of cut so that the blade protrudes 4-5 mm beyond the thickness of the material.

2. At the desired depth of cut, secure the base plate (22) by firmly tightening the wing nut (20).

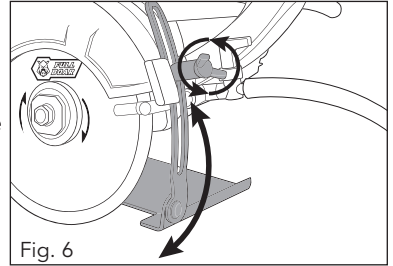

### Bevel angle adjustment

1. To adjust the blade (13) to the desired cutting angle, loosen the bevel bolt (15) with the supplied wrench (14) and tilt the base plate (22) to the desired angle as shown on the bevel scale (fig. 7).

**Note:** The angle of bevel is infinitely adjustable between 0° and 45°.

2. At the desired bevel angle, secure the base plate (22) by firmly tightening the bevel bolt (15).

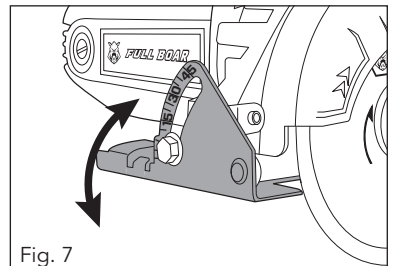

## OPERATION

### On/off trigger (2)

Always firmly hold the tool by handle (4) during operations. The tile cutter is fitted with a lock-off button (1) to avoid accidental start up.

1. First press and hold the lock-off button (1), then squeeze the On/off trigger (2) to start the tool. Hold the trigger in this position for continuous use (fig. 8).

**Note:** Once the tool has started, you can release the lock-off button (1).

2. To stop the tool, simply release the on/off trigger (2).

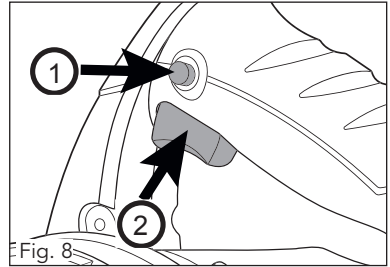

**WARNING!** Always allow the blade (13) to reach full speed before performing any cutting operations.

### Electric shock protection

The power cord of the tile cutter includes a Residual Current Device (RCD) (6), which protects the user against electric shock by interrupting the circuit when a leakage current of 10 mA or greater is detected.



**WARNING!** Do not use the tool if the RCD (6) does not function properly. For the RCD to work, the tool must be connected to an earthed power supply.

1. If the On/Off trigger (2) does not switch on the tool, press the RESET (8) on the RCD (6).
2. The LED (7) on the RCD (6) should light up confirming power is connected to the tool (fig. 9).
3. You can test the RCD (6) by pressing the TEST (9) whilst the tool is running. The power circuit should be broken and the tile cutter will stop operation.

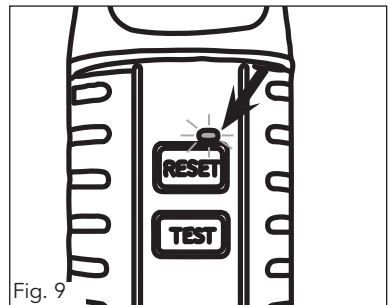

**WARNING!** If in the test mode the RCD (6) does not break the circuit, DO NOT USE THE TOOL. Never use the RCD as a mains switch.

## OPERATION (cont.)

### Cutting tips

- It's best to cut the material in single pass to prevent chipping.
- Make sure the workpiece is securely clamped to a work bench to prevent the workpiece from moving during the cut.
- Set the base plate on the workpiece to be cut without the blade (13) making any contact (fig. 10).

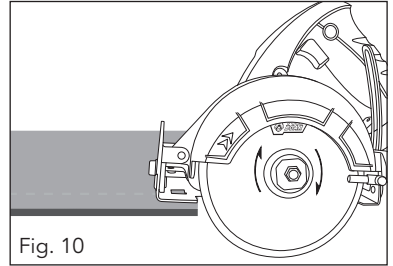

- Allow the blade (13) to reach steady speed before beginning the cut.
- Move the tool forward over the workpiece surface, keeping it flat and advancing smoothly until the cutting is completed.
- Keep your cutting line straight and your speed of advance uniform.
- Be sure to move the tool forward in a straight line and gently. Forcing and exerting excessive pressure or allowing the blade (13) to bend, pinch or twist in the cut can cause overheating of the motor and dangerous kickback of the tool.



**WARNING!** The tool should only be used on horizontal surfaces when wet cutting.



**WARNING!** Never touch the blade (13) while operating.

## MAINTENANCE



**WARNING!** Before cleaning your tile cutter or carrying out any maintenance procedure, make sure that the motor is off and the tile cutter disconnected from the power supply to prevent accidental starting.

### Cleaning

- Keep all safety devices, air vents and the motor housing free of dirt and dust as far as possible. Wipe the equipment with a clean cloth or blow it with compressed air at low pressure.
- We recommend that you clean the device immediately each time you have finished using it.
- Clean the equipment regularly with a moist cloth. Do not use cleaning agents or solvents; these could attack the plastic parts of the equipment.

### Carbon brushes

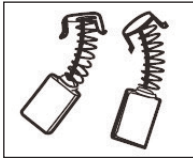

When the carbon brushes wear out, the tool will spark and/or stop. Discontinue use as soon as this happens. They should be replaced prior to recommencing use of the tool. Carbon brushes are a wearing component of the tool, therefore not covered under warranty. Continuing to use the tool when the carbon brushes need to be replaced may cause permanent damage to the tool. Carbon brushes will wear out after many uses but when the carbon brushes need to be replaced, take the tool to an electrician or a power tool repairer for a quick and low cost replacement. Always replace both carbon brushes at the same time.

**Note:** Ozito Industries will not be responsible for any damage or injuries caused by the repair of the tool by an unauthorised person or by mishandling of the tool.

### Spare Parts

Limited spare parts are available subject to availability. Please contact your local Bunnings Special Orders Desk to order the required spare parts.

## CARING FOR THE ENVIRONMENT











Power tools that are no longer usable should not be disposed of with household waste but in an environmentally friendly way. Please recycle where facilities exist. Check with your local council authority for recycling advice.



Recycling packaging reduces the need for landfill and raw materials. Reuse of recycled material decreases pollution in the environment. Please recycle packaging where facilities exist. Check with your local council authority for recycling advice.

## DESCRIPTION OF SYMBOLS

<b>V</b>	Volts.	<b>Hz</b>	Hertz.
~	Alternating current.	<b>W</b>	Watts.
<b>min<sup>-1</sup></b>	Revolutions or reciprocation per minute.	<b>n<sub>0</sub></b>	No load speed.
<b>mm</b>	Millimetres.	∅	Diameter.
	Double insulated.		Regulator compliance mark.
	Warning!		Wear ear, eye and breathing protection.
 	Read instruction manual. Failure to do so could result in personal injury or equipment damage.		
	Danger! Keep hands and fingers clear of cutting blade.		Wear safety gloves.

## CONTENTS

- 1 x 125mm Tile cutter
- 1 x Wet cutting continuous rim diamond blade ∅125 x ∅20mm
- 1 x Wet cutting attachment
- 1 x Hose clamp
- 1 x Spanner
- 1 x Wrench
- 1 x RCD (fitted)
- 1 x Instruction manual

**Note:** The manufacturer's liability shall be deemed void if the tool is modified in any way and the manufacturer shall therefore accept no liability for any damages arising as a result of modifications.

Distributed by:  
Ozito Industries Pty Ltd

### AUSTRALIA (Head Office)

1-23 Letcon Drive, Bangholme Victoria, Australia, 3175  
Telephone: 1800 069 486

# WARRANTY

**YOUR WARRANTY FORM SHOULD BE RETAINED BY YOU AT ALL TIMES. IN ORDER TO MAKE A CLAIM UNDER THIS WARRANTY YOU MUST RETURN THE PRODUCT TO YOUR NEAREST BUNNINGS WAREHOUSE (see [www.bunnings.com.au](http://www.bunnings.com.au) or [www.bunnings.co.nz](http://www.bunnings.co.nz) for store locations) WITH YOUR BUNNINGS REGISTER RECEIPT. PRIOR TO RETURNING YOUR PRODUCT FOR WARRANTY PLEASE TELEPHONE OUR CUSTOMER SERVICE HELPLINE:**

**Australia 1800 069 486  
New Zealand 0508 069 486**

TO ENSURE A SPEEDY RESPONSE PLEASE HAVE THE MODEL NUMBER AND DATE OF PURCHASE AVAILABLE. A CUSTOMER SERVICE REPRESENTATIVE WILL TAKE YOUR CALL AND ANSWER ANY QUESTIONS YOU MAY HAVE RELATING TO THE WARRANTY POLICY OR PROCEDURE.

## 1 YEAR WARRANTY

Your product is guaranteed for a period of **12 months from the original date of purchase**. If a product is defective it will be repaired in accordance with the terms of this warranty. Warranty excludes consumable parts, for example: wheels, bearings.

The benefits provided under this warranty are in addition to other rights and remedies which are available to you under law. The warranty covers manufacturer defects in materials, workmanship and finish under normal use.

Our goods come with guarantees that cannot be excluded under Australian Consumer law & Consumer Guarantees Act 1993 (NZ). You are entitled to a replacement or refund for a major failure and to compensation for other reasonably foreseeable loss or damage. You are also entitled to have the goods repaired and replaced if the goods fail to be of acceptable quality and the failure does not amount to a major failure.

## WARRANTY EXCLUSIONS

**The following actions will result in the warranty being void.**

- If the tool has been operated on a supply voltage other than that specified on the tool.
- If the tool shows signs of damage or defects caused by or resulting from abuse, accidents or alterations.
- Failure to perform maintenance as set out within the instruction manual.
- If the tool is disassembled or tampered with in any way.
- The warranty excludes damage resulting from product misuse or product neglect.

**This warranty is given by Ozito Industries Pty Ltd.**

**ABN: 17 050 731 756**

**Ph.1800 069 486**

Australia/New Zealand (Head Office)  
1-23 Letcon Drive, Bangholme, Victoria, Australia 3175