

## ROLLER BLIND INSTALLATION INSTRUCTIONS

### HOW TO INSTALL

1

Decide how the blind is to be fitted.

A: Top of frame

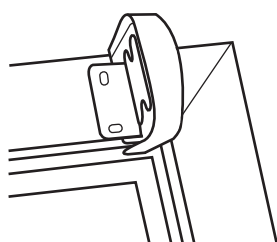

B: Inside frame

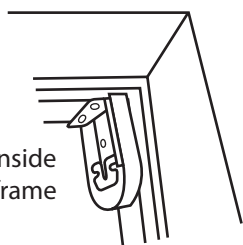

C: Outside frame

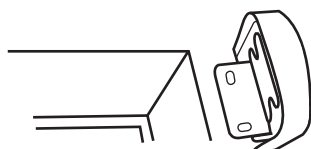

2

Choose which side you would like the chain operation (controller unit), and place the end unit in the opposite end.

Controller Unit

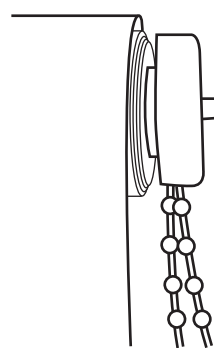

End Unit

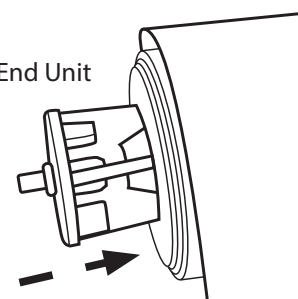

3

To mark out where to install your blind, attach bracket A to the controller unit and bracket B to the end unit.

Bracket A

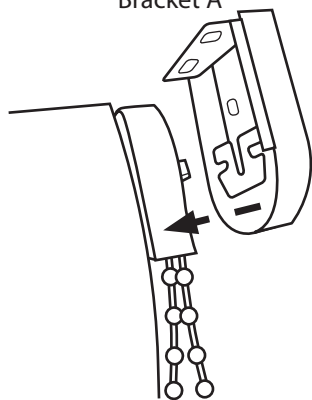

Bracket B

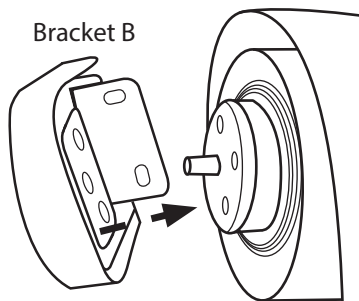

4

Hold the blind up against the window where the brackets meet the window frame/wall, using a pencil mark the screw holes (you may wish to use a spirit level).

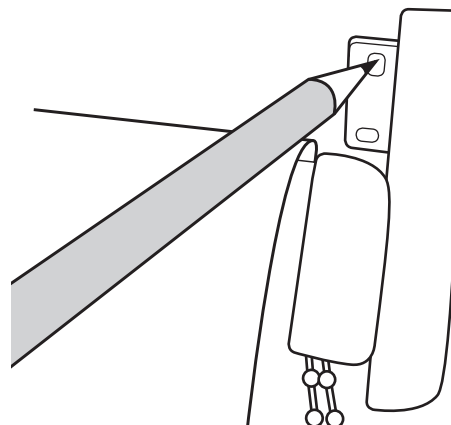

5

Pre drill screw holes and fix the brackets with a screw driver. Do not over tighten the screws.

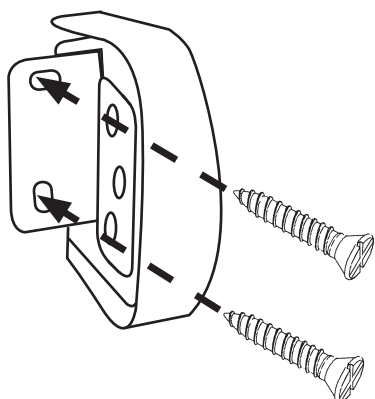

6

Now slot both ends of the blind into the brackets.

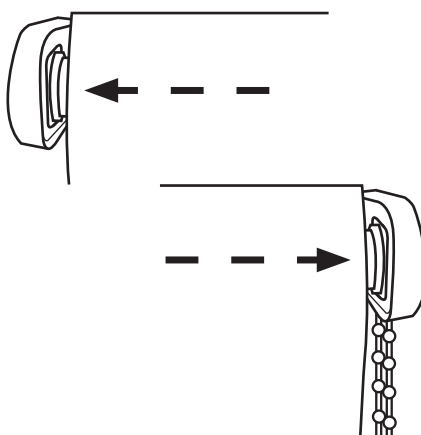

7

Attach the safety chain device to the window frame or wall. Ensure the ball chain is taut at all times to reduce the risk of strangulation on children.

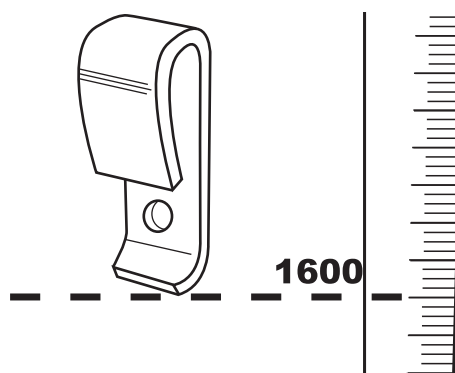



A cord guide may be installed lower than 1600mm above floor level if the cord is sufficiently secured or tensioned to prevent a loop of 220mm or longer from being formed.

If a cord guide is installed lower than 1600mm above floor level it must be designed to prevent a child from being able to remove the cord; and

If a cleat is used to secure the cord it must be at least 1600mm above the floor level because a child is capable of unwinding a cord from a cleat.

## HOW TO OPERATE YOUR BLIND

1

To raise and lower the blind use the ball chain.

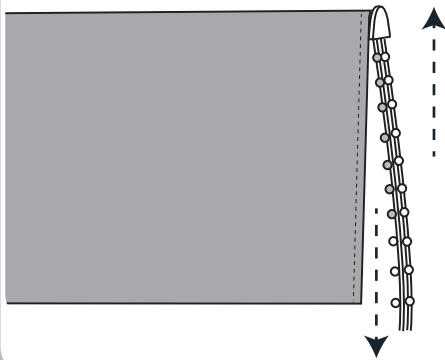

## HOW TO CARE FOR YOUR BLIND

1

Gently vacuum with a appropriate attachment.

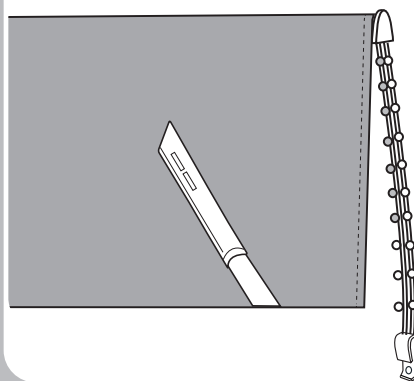

2

Spot clean with a damp sponge if necessary

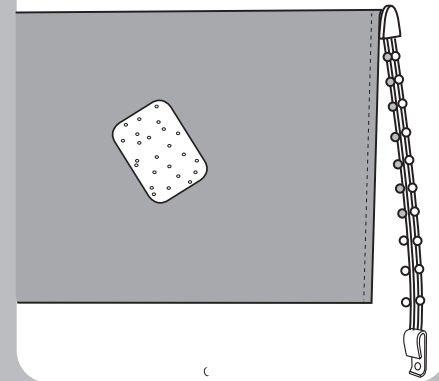

## ACCESSORIES ENCLOSED

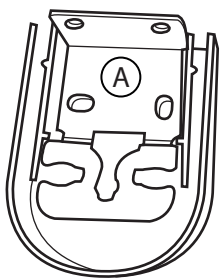

A

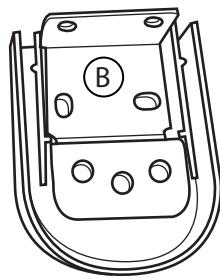

B

Brackets x2

End Unit

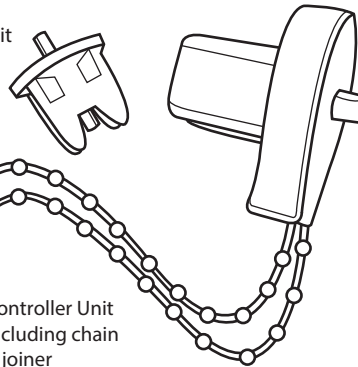

Controller Unit  
including chain  
& joiner

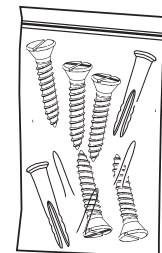

Fixing Screws and  
Masonry Plugs

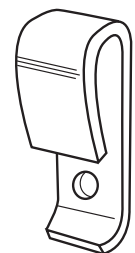

Safety Chain  
Device



**WARNING**



**WARNING: CURTAIN AND BLIND CORDS HAVE CAUSED THE DEATH OF YOUNG CHILDREN AND MUST BE INSTALLED SO THAT THEY ARE NOT A STRANGULATION HAZARD. FOLLOW THE INSTALLATION INSTRUCTIONS.**



**WARNING**

Youngs children have died by wrapping loose curtain and blind cords around their necks. Secure cords or chains with cord guides or keep them out of reach by winding them around a cleat. Move cots and furniture away from window covering cords or chains.



**WARNING**

The tension device reduces the hazards of strangulation or entanglement by limiting access to the cord or bead chain. Anchor the device with the cord or bead chain to the wall or floor, so young children cannot pull the cord or bead chain around their necks. Always keep cords out of the reach of young children.

