



150MM ORBITAL AIR SANDER

- **BUILT-IN VACUUM**
- **10,000 MAX RPM**
- **ADJUSTABLE SPEED CONTROL**



INSTRUCTION MANUAL



WARNING: Read all safety warnings and all instructions. Failure to follow the warnings and instructions may result in electrical shock, fire and/or serious injury. Save all warnings and instructions for future reference.

SPECIFICATIONS - MODEL NO. FBAS-150

Max RPM:	10,000
Pad Size:	150mm
Pad Weight:	130 grams
Air Inlet:	1/4 Nitto Style Male Connector
Operating Pressure:	6.2 bar (90 psi)
Maximum Pressure:	10.3 bar (150 psi)
Weight:	1.0 kg
Air Consumption:	140 litres/min at 90 psi

KNOW YOUR PRODUCT

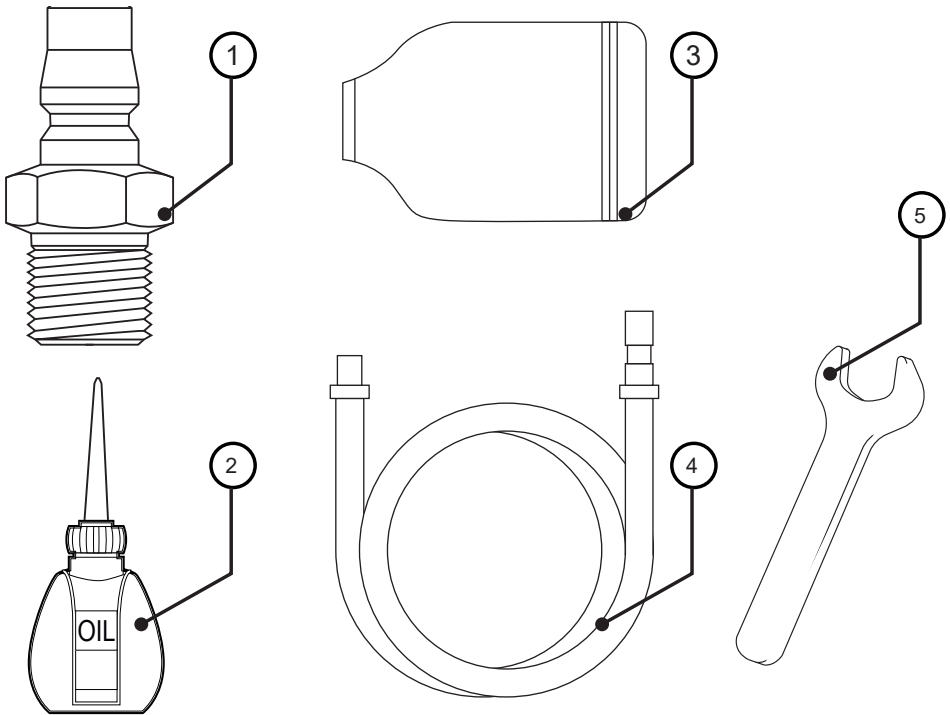

1. 1/4 Nitto Style Male Connector
2. Oil Bottle
3. Vacuum Bag

4. Vacuum Hose
5. 24mm Wrench

KNOW YOUR PRODUCT

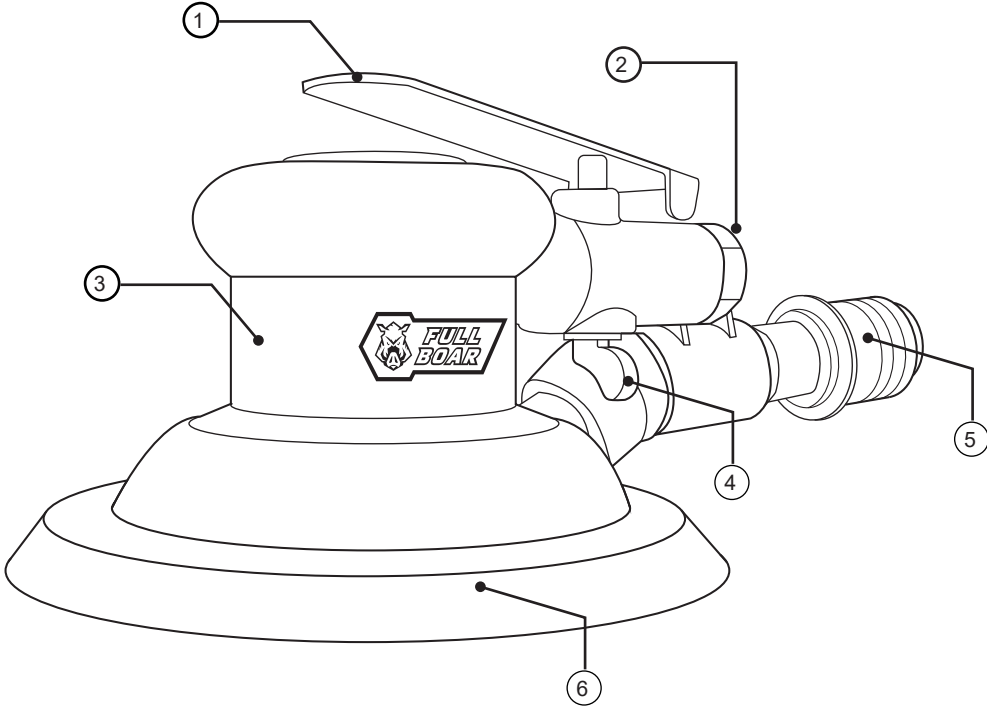

- 1. Palm Throttle Lever
- 2. Air Inlet
- 3. Grip
- 4. Adjustable Speed Control

- 5. Vacuum Attachment
- 6. Sanding Pad

TABLE OF CONTENTS

SPECIFICATIONS.....	Page 02
KNOW YOUR PRODUCT.....	Page 02
INTRODUCTION.....	Page 05
SAFETY INSTRUCTIONS.....	Page 06
SET UP AND PREPARATION.....	Page 10
OPERATION.....	Page 12
MAINTENANCE.....	Page 13
TROUBLE SHOOTING	Page 14
DESCRIPTION OF SYMBOLS.....	Page 15
CONTENTS.....	Page 16
WARRANTY.....	Page 17

INTRODUCTION

The Full Boar 150mm Orbital Air Sander is perfect for sanding or finishing curved and flat surfaces such as timber, metal, and fibreglass. Suitable for use with 6 inch hook and loop sanding pads, this tools random orbital pattern produces a superior surface finish.

Read and understand the Owner's Manual before operating the Air Sander. Failure to do so could result in personal injury or equipment damage.

LUBRICATION

An automatic in-line filter, a pressure regulator and automatic oiler is recommended as it increases the products service life. The in-line oiler should be checked regularly and filled with air tool oil.

It is most important that the product be properly lubricated by keeping the air line lubricator filled and correctly adjusted. Without proper lubrication the product will not work properly and parts will wear prematurely.

Use correct lubricant in the air line lubricator. The lubricator should be of low air flow or changing air flow type, and should be kept filled to the correct level. Use only recommended lubricants, specially made for pneumatic applications. Substitutes may harm the rubber compounds in the product's O-rings and other rubber parts.

GENERAL AIR TOOL SAFETY WARNINGS



WARNING! Read all safety warnings and all instructions. Failure to follow the warnings and instructions may result in electric shock, fire and/or serious injury.

Save all warnings and instructions for future reference.

1. Work area safety

- a. **Keep work area clean and well lit.** Cluttered or dark areas invite accidents.
- b. **Do not operate power tools in explosive atmospheres, such as in the presence of flammable liquids, gases or dust.** Power tools create sparks which may ignite the dust or fumes.
- c. **Keep children and bystanders away while operating a power tool.** Distractions can cause you to lose control.
- d. **Dress properly. Do not wear loose clothing or jewellery. Keep your hair, clothing and gloves away from moving parts.** Loose clothes, jewellery or long hair can be caught in moving parts.
- e. **Check the maximum pressure rating of any tools or accessories that you intend using with the compressor.** The output pressure of the air from the compressor must be regulated so that it never exceeds the rated pressure of the tool or accessory.
- f. **Always wear high safety goggles or glasses when using the air tools.** Never point the air tool towards any part of your body or towards another person.
- g. **Drain the moisture from the tank daily.** It will help prevent corrosion.
- h. Use safety equipment including safety goggles and ear protection, the tool operator and all persons in the working area must wear safety goggles and ear protection.
- i. Air tools should not be used in a potentially explosive environment.
- j. **The tool must be used only for its prescribed purpose.** Any use other than those mentioned in this Manual will be considered a case of misuse. The user and not the manufacturer shall be liable for any damage or injury resulting from such cases of misuse.



WARNING! In the event that an air line is cut or broken, the air supply must be turned off at the compressor. A broken air line which is not supported is extremely dangerous and can whip around very quickly, both with the capability of striking people, and blowing foreign particles into the air.

Do not attempt to catch the air line but immediately keep bystanders well clear and turn off the air supply to the hose, turn off the compressor at the On / Off button, and then remove the hose from the compressor.

GENERAL AIR TOOL SAFETY WARNINGS (cont.)

- Please read and observe these operating instructions before using the tool. Basic safety measures should always be strictly followed to protect against damage to the equipment and personal injury to the user or other people working in the vicinity of operation.
- This appliance is not intended for use by persons (including children) with reduced physical, sensory or mental capabilities, or lack of experience and knowledge, unless they have been given the supervision or instruction concerning use of the appliance by a person responsible for their safety.
- **Children should be supervised to ensure that they do not play with the appliance.**



WARNING! Do not over reach. Keep proper footing and balance at all times.



WARNING! Do not attempt to modify this tool or install accessories not recommended for use with this tool. Any such in a hazardous condition leading to possible serious personal injury.



WARNING! Do not climb rigging or scaffolding while carrying a tool that is connected to an air hose. Doing so could result in serious personal injury..

ORBITAL AIR SANDER SAFETY WARNINGS



WARNING! Disconnect the tool from the air supply before inspecting the air tool. Failure to do so could result in serious personal injury.

- **Read and understand instruction manual before using.**
- **Always wear impact-resistant eye protection during the operation of the air tool.**
- **Do not use this product if it is not completely assembled or if any parts appear to be missing or damaged.** Use of a product that is not properly and completely assembled could result in serious personal injury.
- Do not carry tool with finger on the trigger.
- **Disconnect the tool from the air supply before performing maintenance,** leaving work area, moving tool to another location, making any adjustments, during non-operation or handing tool to another person. Failure to do so could result in serious personal injury.
- **Clean and inspect the tool daily.** Carefully check for proper operation of trigger and safety mechanism.
- **DO NOT use the tool unless the trigger is functional,** or if the tool is leaking air or needs any other repair.
- **Be aware that the failure of the work piece,** or accessories, or even of the air tool itself, can generate high-velocity projectiles.
- Air under pressure can cause severe injury.
- **Whipping hoses can cause severe injury.** Always check for damaged or loose hoses and fittings.
- DO NOT exceed the maximum pressure stated on the tool.
- Never carry an air tool by the hose.
- Quick connector couplings shall be used for connection to the compressed air system and non-sealable air inlet connector must be fitted at the tool in such a way that no compressed air remains in the tool after disconnection.
- Air tools shall only be connected to an air supply where the maximum allowable pressure of the tool cannot be exceeded by more than 10%; in the case of higher pressure, a pressure reducing valve which includes a downstream safety valve shall be built into the compressed air supply.
- Check prior to each operation that the safety and triggering mechanism is functioning properly and that all nuts and bolts are tight.
- Do not carry out any alterations to the air tool.
- **Avoid weakening or damaging the tool, for example by:**
 - punching or engraving;
 - modification not authorized by the manufacturer;
 - guiding against templates made of hard material such as steel;
 - dropping or pushing across the floor;
 - applying excessive force of any kind..

ORBITAL AIR SANDER SAFETY WARNINGS

- **Do not connect tool** to pressure that potentially exceeds 150 psi (10.3 bar).
- **Only use clean**, dry and regulated compressed air at 6.2 bar (90psi)
- Only technically skilled operators should use the air tool.
- Do not overreach. Only use in a safe working place. Keep proper footing and balance at all times.
- Keep bystanders away (when working in an area where there is a likelihood of through traffic of people). Clearly mark off your operating area.
- Only wear gloves that provide adequate feel and safe control of triggers and any adjusting devices.
- The tool must be disconnected from the air supply and rested on a flat surface when not in use.
- Always wear impact-resistant eye protection with side shields during operation of the tool.
- Appropriate hearing protection shall be worn.
- The risks to others shall be assessed by the operator.
- Ensure the tool is correctly lubricated during use. Only use the correct lubricant as specified in this manual.
- Slips, trips and falls are major causes of workplace injury. Be aware of slippery surfaces caused by use of the tool and also of trip hazards caused by the airline hose.
- Proceed with additional care in unfamiliar surroundings. Hidden hazards may exist, such as electricity or other utility lines.
- This tool is not intended for use in potentially explosive atmospheres and is not insulated from coming into contact with electric power.
- Never use oxygen or combustible gases for operating pneumatic tools as this could create a fire and explosion hazard.
- Do not discard the manual and safety instructions.
- **Keep away from rotating end of tool.** Do not wear jewellery or loose clothing. Secure long hair. Scalping can occur if hair is not kept away from tool and accessories. Choking can occur if neckwear is not kept away from tool.
- Gloves can become entangled with the rotating pad, causing severed or broken fingers.
- Rotating discs can easily entangle rubber-coated or metal-reinforced gloves.
- Do not wear loose-fitting gloves or gloves with cut or frayed fingers.
- Hold the tool correctly; be ready to counteract normal or sudden movements and have both hands available.
- Release the trigger in the case of an interruption to the air supply.
- Potentially explosive atmospheres can be caused by dust and fumes resulting from sanding or grinding. Always use dust extraction or suppression systems which are suitable for the material being processed.
- Grinding wheels and cutting-off tools shall not be used.

ORBITAL AIR SANDER SAFETY WARNINGS

- Check the maximum operating speed of the backing pad is higher than the rated speed of the sander.
- Dust and fumes generated when using sanders can cause ill health. All integral features or accessories for the collection, extraction or suppression of airborne dust or fumes should be correctly used and maintained in accordance with these instructions.
- Use respiratory protection in accordance with the local health and safety regulations. Always assess the material being processed and take appropriate measures to minimize and/or remove expose.

SET UP & PREPARATION



WARNING! Ensure the tool is in the off position before connecting to the air supply.

Connecting air supply

1. Wrap Teflon tape (not supplied) around the Nitto Style Fitting approximately 4 to 5 times to ensure a leak free seal.

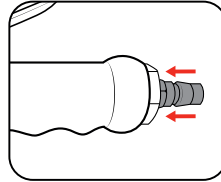
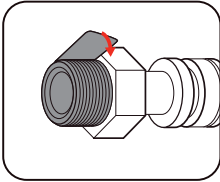

2. Screw in Nitto Style Fitting to the air inlet of the Air Sander.

3. Fasten the Nitto Style Fitting using a 14mm spanner (not supplied).

Add air tool lubricate into the air tool once daily with minimal use, or twice a day with heavy use. Only a few drops of oil at a time is necessary. Too much oil will only collect inside the tool and will be noticeable in the exhaust cycle. Warning! use only air tool oil to lubricate the tool.

Before connecting the tool, check the air compressor gauge to be sure it is functioning within the proper range 6.2 bar (90 psi).

Note: The tool and air hose must have a quick-connect hose coupling that allows all pressure to be removed from the tool when the coupling is disconnected.

1. Pull back the sleeve on female quick connector hose coupling, insert male end and release sleeve on quick connector.

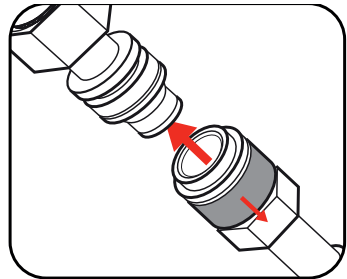

Note: For best performance use 3/8" I/D supply air hose.



WARNING! Always use a coupling that discharges all the compressed air in the tool at the time the fitting or hose coupling is disconnected. Using a coupling that does not discharge the compressed air could cause unintended operation and serious personal injury..

SET UP & PREPARATION



WARNING! Disconnect the Air Sander from the air supply before carrying out maintenance and/or changing the sanding sheet.



WARNING! Always inspect the sanding pad and the sand paper for any wear/damage. Replace damaged pad or sandpaper before use.

Changing 150mm Sanding Sheet

1. Ensure the sanding pad has come to a complete stop and the tool is disconnected from the air supply.
2. Peel and discard of used sheet. Secure a new sanding sheet using the hook and fastening system, be sure to check the sanding sheet is the correct diameter for use with this tool.
3. Firmly secure the new pad to the Air Sander before connecting the tool to the air supply. The tool is now ready for use.

Connecting Vacuum Air Hose

1. Ensure the sanding pad has come to a complete stop and the tool is disconnected from the air supply.
2. Connect the Silicone end of the vacuum hose to the Air Sander. Ensure the connection is secure and air tight.

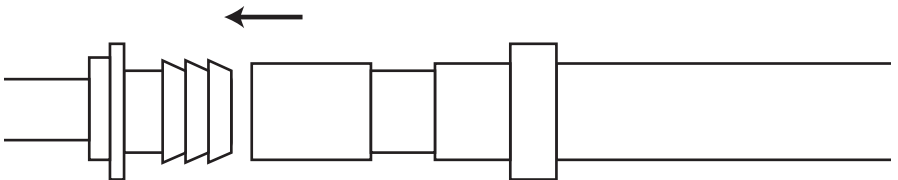

SET UP & PREPARATION

Connecting Dust Bag

1. Ensure the sanding pad has come to a complete stop and the tool is disconnected from the air supply.

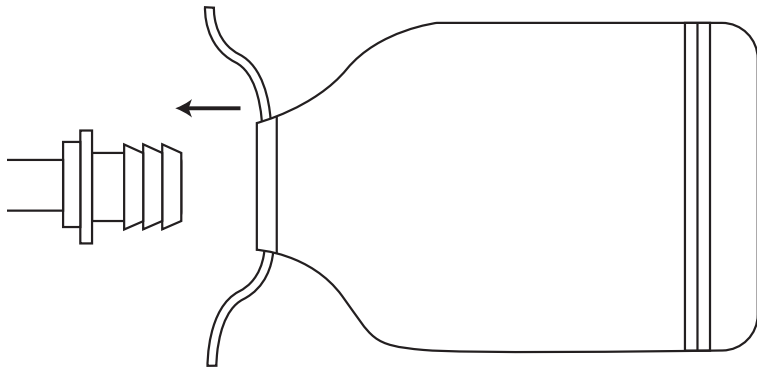

2. Tie the supplied Dust Bag to the vacuum hose connection. Ensure to regularly check and empty the bag.

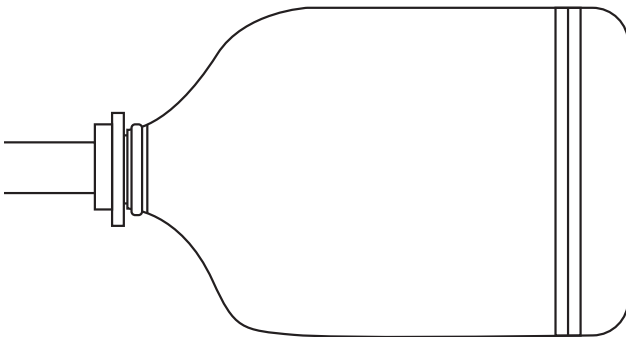

OPERATION



WARNING! Ensure that the compressed air does not exceed 150 psi (10.3 bar) while operating the tool. Too high an air pressure and unclean air will shorten the product's life due to excessive wear, and may be dangerous causing damage and/or personal injury.

General Operation

1. Ensure the tool is connected to an air supply with the correct pressure settings
2. To operate the Air Sander, squeeze the palm throttle lever to turn on the tool. Ensure the tool is not engaged with any material when the disk starts to spin.
3. Place the spinning disc on the surface and keeping a light pressure move the tool around the work piece.

Do not apply heavy pressure to the Air Sander to avoid damage to the work piece and tool.

4. Release the trigger and allow the sanding disc to come to a complete stop before placing the tool down.

Variable Speed Adjustment

To change the speed of the sanding pad turn the speed control knob. Be sure the tool is no connected to an air supply to prevent accidental start ups when adjusting the knob.

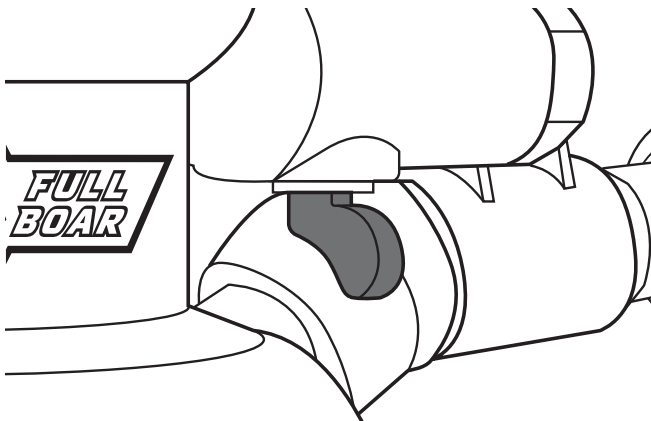

MAINTENANCE

General Cleaning

- If the enclosure of the tool requires cleaning, do not use solvents but a moist soft cloth only. Never let any liquid get inside the tool; never immerse any part of the tool into a liquid.
- Store the tool in a dry and safe place out of reach of children.
- Oil the air tool after each use with air tool oil.

Note: TB Imports will not be responsible for any damage or injuries caused by the repair of the tool by an unauthorised person or by mishandling of the tool.









Spare Parts

Limited spare parts are available subject to availability. Please contact your local Bunnings Special Orders Desk to order the required spare parts.

TROUBLESHOOTING

PROBLEM	POSSIBLE CAUSE	POSSIBLE REMEDY
Air leak near the top of the tool or in the trigger area.	Loose screws	Tighten screws
	Worn or damaged o-rings or seals	Check and replace O-rings
Air leak near the base of the tool	Loose screws	Tighten screws
	Worn or damages o-rings or seals	Check and replace O-rings
Tool does nothing or operates sluggishly	Insufficient air supply	Increase air flow to tool (Do not exceed 150psi)
	Insufficient lubrication	Lubricate tool
	Worn or damaged o-rings	Check and replace O-rings
Air Sander not sufficiently sanding material.	Insufficient air supply	Increase air flow to tool (Do not exceed 150psi)

DESCRIPTION OF SYMBOLS

	Revolutions or reciprocations per minute		No load speed
	Wear eye, ear & breathing protection		Wear hearing protection
	Wear breathing protection		Wear eye protection
	Read Instruction Manual		Warning

CONTENTS

- | | |
|------------------------------------|------------------|
| 1 x Air Sander | 1 x 24mm Spanner |
| 1 x 1/4 Nitto Style Male Connector | 1 x Dust Bag |
| 1 x Instruction Manual | 1 x Vacuum Hose |
| 1 x Oil Bottle | |

CARING FOR THE ENVIRONMENT



Power tools that are no longer usable should not be disposed of with household waste but in an environmentally friendly way. Please recycle where facilities exist. Check with your local council authority for recycling advice.



Recycling packaging reduces the need for landfill and raw materials. Reuse of recycled material decreases pollution in the environment. Please recycle packaging where facilities exist. Check with your local council authority for recycling advice.

Note: The manufacturer's liability shall be deemed void if the tool is modified in any way and the manufacturer shall therefore accept no liability for any damages arising as a result of modifications.

Distributed by:
TB Imports

AUSTRALIA (Head Office)

25 Fox Drive, Dandenong South, Victoria, Australia, 3175

Telephone: 1800 951 371 (AUS), 0800 647 840 (NZ)

WARRANTY

YOUR WARRANTY FORM SHOULD BE RETAINED BY YOU AT ALL TIMES. IN ORDER TO MAKE A CLAIM UNDER THIS WARRANTY YOU MUST RETURN THE PRODUCT TO YOUR NEAREST BUNNINGS WAREHOUSE (see www.bunnings.com.au or www.bunnings.co.nz for store locations) WITH YOUR BUNNINGS REGISTER RECEIPT. PRIOR TO RETURNING YOUR PRODUCT FOR WARRANTY PLEASE TELEPHONE OUR CUSTOMER SERVICE HELPLINE:

**Australia 1800 951 371
New Zealand 0800 647 840**

TO ENSURE A SPEEDY RESPONSE PLEASE HAVE THE MODEL NUMBER AND DATE OF PURCHASE AVAILABLE. A CUSTOMER SERVICE REPRESENTATIVE WILL TAKE YOUR CALL AND ANSWER ANY QUESTIONS YOU MAY HAVE RELATING TO THE WARRANTY POLICY OR PROCEDURE.

1 YEAR WARRANTY

Your product is guaranteed for a period of **12 months from the original date of purchase**. If a product is defective it will be repaired in accordance with the terms of this warranty. Warranty excludes consumable parts, for example: wheels, bearings.

The benefits provided under this warranty are in addition to other rights and remedies which are available to you under law. The warranty covers manufacturer defects in materials, workmanship and finish under normal use.

Our goods come with guarantees that cannot be excluded under Australian Consumer law & Consumer Guarantees Act 1993 (NZ). You are entitled to a replacement or refund for a major failure and to compensation for other reasonably foreseeable loss or damage. You are also entitled to have the goods repaired and replaced if the goods fail to be of acceptable quality and the failure does not amount to a major failure.

WARRANTY EXCLUSIONS

The following actions will result in the warranty being void.

- If the tool has been operated on a supply voltage other than that specified on the tool.
- If the tool shows signs of damage or defects caused by or resulting from abuse, accidents or alterations.
- Failure to perform maintenance as set out within the instruction manual.
- If the tool is disassembled or tampered with in any way.
- The warranty excludes damage resulting from product misuse or product neglect.

This warranty is given by TB Imports.

ABN: 17 050 731 756

Ph. 1800 951 371 (AUS)

0800 647 840 (NZ)

Australia/New Zealand (Head Office)
25 Fox Drive, Dandenong South, Victoria, Australia 3175