



18V CORDLESS

165MM CIRCULAR SAW

INSTRUCTION MANUAL

SPECIFICATIONS

Input:	18V
No Load Speed:	4,200/min
Blade Diameter:	165mm (6.5")
Blade Teeth:	24TCT
Blade Bore:	20mm
Depth of Cut:	54mm @ 90° 35mm @ 45°
Weight:	2.59kg

ozito.com.au

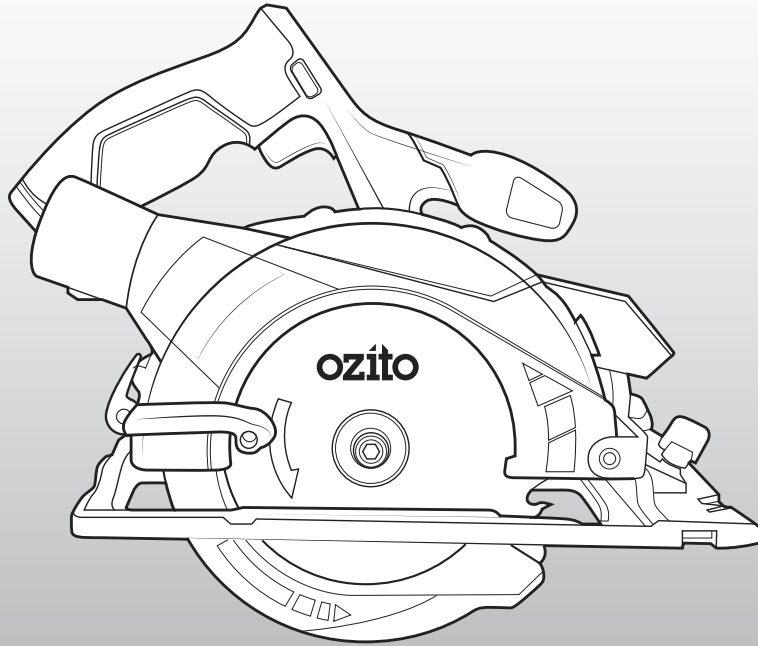

STANDARD EQUIPMENT

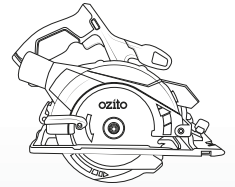

Circular Saw

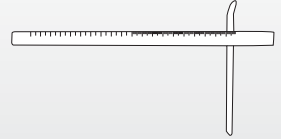

Rip Fence

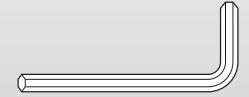

Hex Key

5 YEAR
REPLACEMENT WARRANTY

PXCSS-165

WARRANTY

IN ORDER TO MAKE A CLAIM UNDER THIS WARRANTY YOU MUST RETURN THE PRODUCT TO YOUR NEAREST BUNNINGS WAREHOUSE WITH YOUR BUNNINGS REGISTER RECEIPT. PRIOR TO RETURNING YOUR PRODUCT FOR WARRANTY PLEASE TELEPHONE OUR CUSTOMER SERVICE HELPLINE:

Australia 1800 069 486
New Zealand 0508 069 486

TO ENSURE A SPEEDY RESPONSE PLEASE HAVE THE MODEL NUMBER AND DATE OF PURCHASE AVAILABLE. A CUSTOMER SERVICE REPRESENTATIVE WILL TAKE YOUR CALL AND ANSWER ANY QUESTIONS YOU MAY HAVE RELATING TO THE WARRANTY POLICY OR PROCEDURE.

WARNING

The following actions will result in the warranty being void.

- If the tool has been operated on a supply voltage other than that specified on the tool.
- If the tool shows signs of damage or defects caused by or resulting from abuse, accidents or alterations.
- Failure to perform maintenance as set out within the instruction manual.
- If the tool is disassembled or tampered with in any way.

The benefits provided under this warranty are in addition to other rights and remedies which are available to you at law.

Our goods come with guarantees that cannot be excluded at law. You are entitled to a replacement or refund for a major failure and for compensation for any other reasonably foreseeable loss or damage. You are also entitled to have the goods repaired or replaced if the goods fail to be of acceptable quality and the failure does not amount to a major failure.

Generally you will be responsible for all costs associated with a claim under this warranty, however, where you have suffered any additional direct loss as a result of a defective product you may be able to claim such expenses by contacting our customer service helpline above.

5 YEAR REPLACEMENT WARRANTY

Your Product is guaranteed for a period of 60 months from the original date of purchase and is intended for DIY (Do It Yourself) use only. If a product is defective it will be replaced in accordance with the terms of this warranty. **Lithium Ion batteries and chargers are covered by a 36 month warranty** and are excluded from the warranty extension. Warranty excludes consumable parts.

KNOW YOUR PRODUCT

CORDLESS CIRCULAR SAW

- | | |
|------------------------|----------------------------|
| 1. Spindle Lock | 10. Rip Fence Locking Knob |
| 2. Hex Key Storage | 11. Cutting Guide Notch |
| 3. Worklight | 12. Upper Blade Guard |
| 4. Bevel Locking Lever | 13. Lower Blade Guard |
| 5. Dust Port | 14. Blade Bolt |
| 6. Rear Handle | 15. On/Off Trigger |
| 7. Lock-Off Button | 16. Blade Guard Lever |
| 8. Blade | 17. Depth locking Lever |
| 9. Front Handle | 18. Battery Seating |

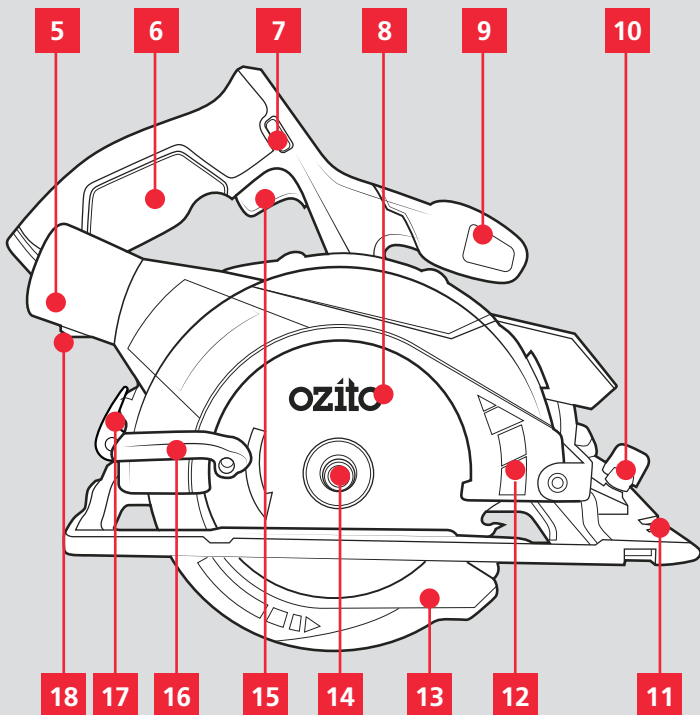
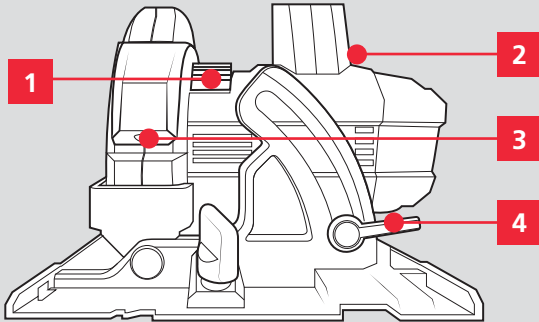

BATTERY & CHARGER

This tool is compatible with all batteries & chargers from the Ozito PXC range.

For optimal performance, we recommend the use of a 3.0Ah battery or higher to operate this PXC tool.

ONLINE MANUAL

Scan this QR Code with your mobile device to take you to the online manual.



SETUP & PREPARATION

1. FITTING THE BATTERY & GUIDE

Installing & Removing The Battery Pack

- Slide the battery into the tool base until it clicks into place.

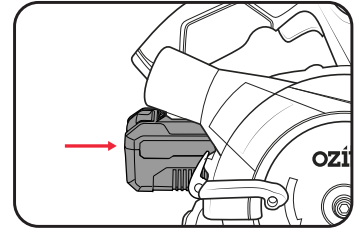

- To remove the battery, hold down the battery release button and then slide the battery out.

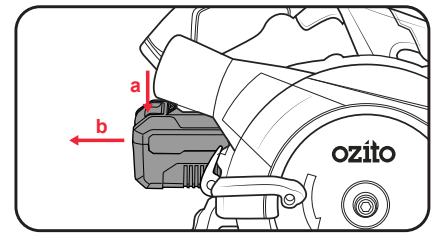

Attaching The Rip Fence

The rip fence allows you to perform straight cuts with ease.



WARNING! ENSURE THE TOOL IS SWITCHED OFF AND THE BATTERY IS REMOVED BEFORE PERFORMING ANY OF THE FOLLOWING TASKS.

- Insert the rip fence through the rip fence slots in the front of the baseplate.

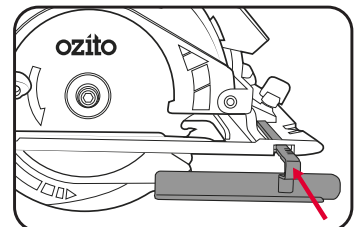

- Once the desired width is set, tighten the locking knob to secure in place.

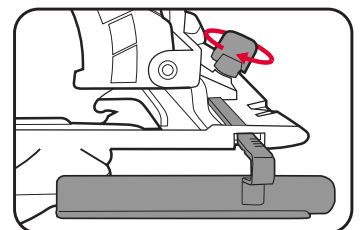

- To remove, loosen the locking knob and then slide the rip fence out.

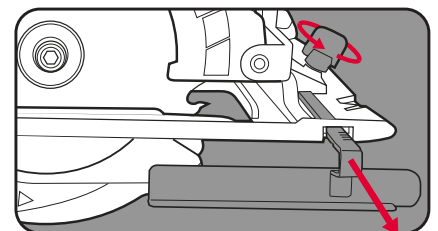

5 YEAR
REPLACEMENT WARRANTY

2. FITTING A BLADE

WARNING! ENSURE THE TOOL IS SWITCHED OFF AND THE BATTERY IS REMOVED BEFORE PERFORMING ANY OF THE FOLLOWING TASKS.

WARNING! INSPECT THE BLADES BEFORE EACH USE. REPLACE IF DAMAGED.

WARNING! ALWAYS WEAR GLOVES WHEN HANDLING THE BLADE AS IT IS VERY SHARP AND CAN CUT YOU WHEN IT IS NOT MOVING.

Changing The Blade

This tool is for wood cutting only and is not recommended for use with abrasive wheels or masonry/diamond cutting wheels. Only use Ø165mm wood cutting blades.

1. Press and hold the spindle lock.

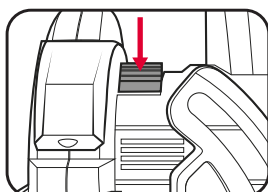

2. Use the hex key to rotate the blade until the spindle lock engages. Remove the blade bolt and outer blade flange.

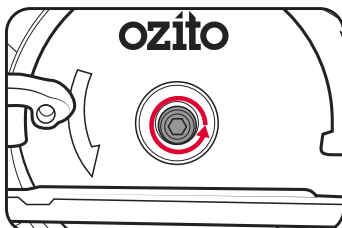

3. Retract the lower blade guard fully.

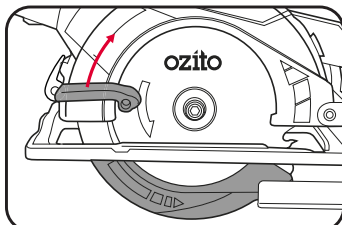

4. Remove and replace the blade. Ensure that the arrows on the blade point in the same direction as the arrow on the upper blade guard.

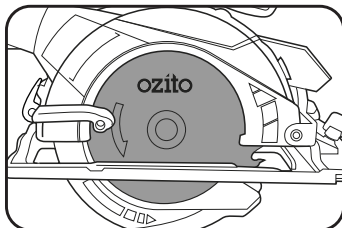

5. Replace the outer blade flange and blade bolt.

WARNING! ONLY USE BLADES WITH THE CORRECT SIZE AND SHAPE OF BORE HOLE. ONLY USE THE FLANGE AND BOLT SUPPLIED WITH THE TOOL.

6. Hold down the spindle lock and tighten the blade bolt with the hex key.

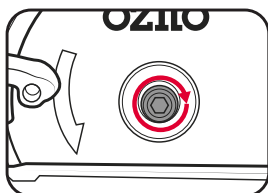

3. CUTTING ADJUSTMENTS

WARNING! ENSURE THE TOOL IS SWITCHED OFF AND THE BATTERY IS REMOVED BEFORE PERFORMING ANY OF THE FOLLOWING TASKS.

Depth Adjustment

Depth should be adjusted so that no more than one tooth is protruding through the timber. This helps to minimise splintering.

1. Loosen the depth adjustment lever.

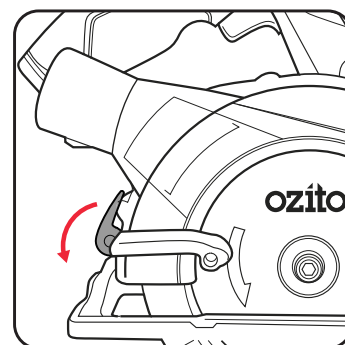

Note: Do not push the lever behind the depth adjustment scale.

2. Hold the baseplate down with one hand. Raise or lower the saw to the desired depth.

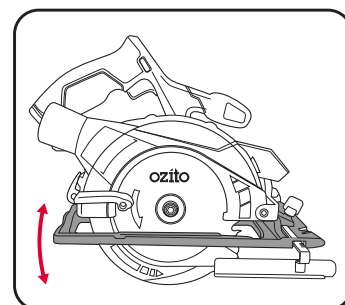

3. Tighten the depth adjustment lever to secure in place.

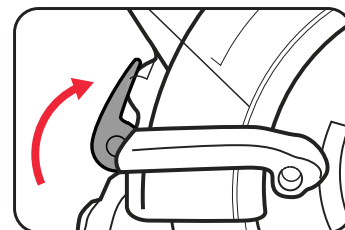

OPERATION

Bevel Adjustment

1. Loosen the bevel adjustment lever.

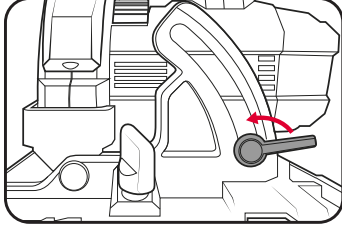

2. Align the baseplate to the desired angle on the bevel scale.

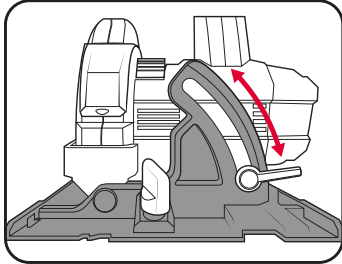

3. Tighten the bevel adjustment lever.

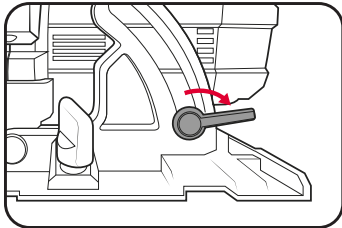

4. CONTROLS

Turning The Tool On & Off

1. Press and hold the safety lock-off button in either direction.

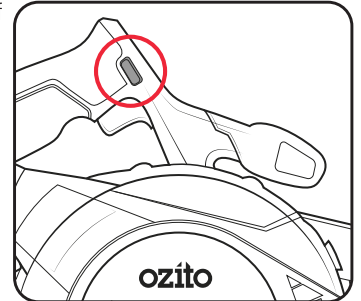

2. Squeeze the on/off trigger to start the saw.

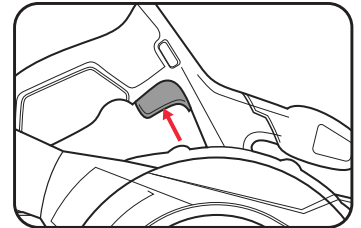

Note: Allow the saw to reach steady speed before beginning a cut.

3. To stop the saw, release the on/off trigger.



WARNING! AFTER USE, HOLD THE SAW AWAY FROM YOUR BODY UNTIL THE BLADE STOPS SPINNING COMPLETELY.

Note: Do not put down the saw until the blade has stopped completely.

Cutting Guide Notch

The cutting guide notches provide an approximate line of cut depending on the bevel angle of the blade.

For a straight cut, use the 0° notch. For a 45° bevel cut, use the 45° notch. Approximate between the two notches for other angles of bevel cut.

Note: Always test cut settings on a scrap piece of wood.

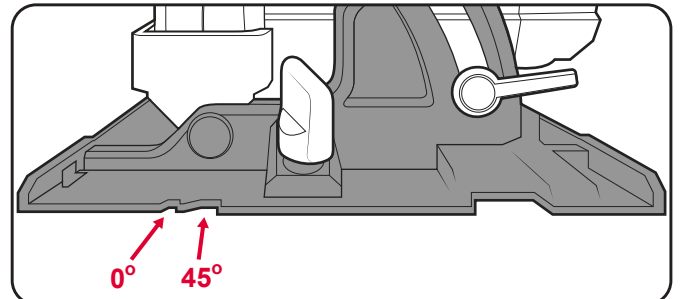

Worklight

The worklight provides additional lighting while the saw is operating to help you see what you are cutting.

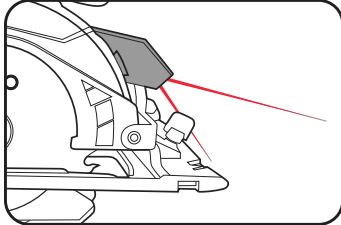

Pressing the lock-off button in either direction will automatically trigger the worklight.

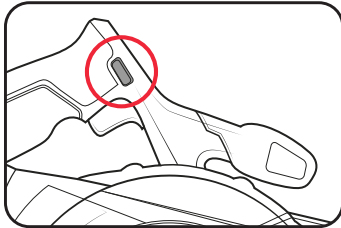

Dust Extraction Port

A vacuum hose or dust extractor can be fitted to the dust extraction port to help keep your workpiece clean.

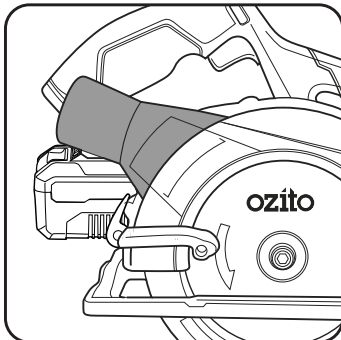

5. MAKING A CUT

1. Mark the cutting line on the workpiece.

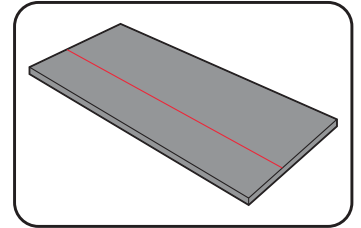

WARNING! INSPECT MATERIAL BEFORE CUTTING. REMOVE ANY NAILS/FOREIGN OBJECTS BEFORE STARTING THE CUT.

WARNING! MAKE SURE THE WORKPIECE IS SECURELY CLAMPED TO A WORKBENCH BEFORE MAKING ANY CUTS.

WARNING! ENSURE THE TOOL IS COMPLETELY STOPPED AND THE BATTERY IS REMOVED BEFORE MAKING ADJUSTMENTS/INSPECTION.

2. Adjust the saw depth and bevel angle for the desired cut.

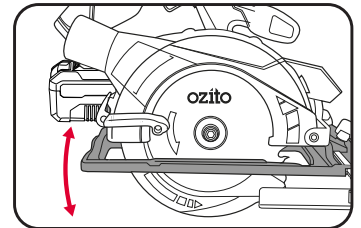

3. Attach the rip fence for an additional guide.

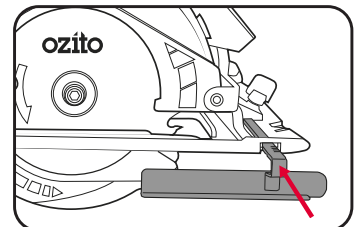

4. Hold the saw securely with both hands and start the tool.

Note: Allow the blade to reach steady speed before beginning the cut.

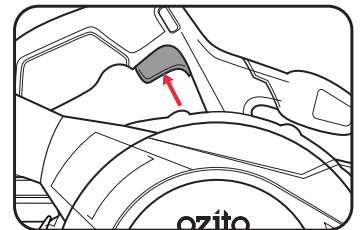

WARNING! KEEP HANDS & BODY PARTS AWAY FROM THE BLADE AT ALL TIMES.

5. Move the saw through the material to perform the cut. Once complete, release the on/off trigger and remove the saw from the workpiece.

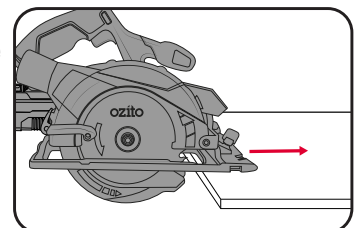

Note: Never force the saw; allow the tool to do the work. Use light and continuous pressure whilst cutting.

Usage Tips

1. Always hold the rear handle with one hand and the front handle with the other.

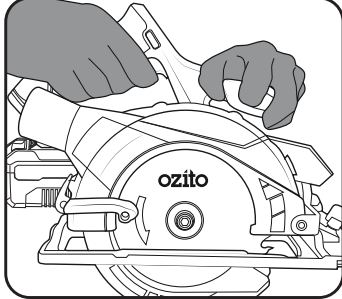

2. Maintain a firm grip and operate the on/off switch with a positive action.
3. Never force the saw; use light and continuous pressure.
4. When cutting is interrupted, do not restart the tool in the middle of the cut/workpiece. Remove the blade from the cut, restart the tool and allow the blade to reach steady speed before slowly and steadily re-entering the cut and resuming.
5. When cutting across the grain, the fibres of the wood have a tendency to tear and lift. Advancing the saw slowly minimises this effect.
6. For a finer finish cut, a cross cut blade or mitre blade is recommended.

6. TROUBLESHOOTING

Worklight does not turn on

The worklight only illuminates once the lock-off button is pressed to either side of the handle.

Ensure that the light source is not covered in dust. Use a dry cloth to wipe away dust.

MAINTENANCE



WARNING! BEFORE CLEANING OR CARRYING OUT ANY MAINTENANCE PROCEDURE, ENSURE THAT THE BATTERIES HAVE BEEN REMOVED.

Cleaning

- Keep the ventilation slots of the tool clean at all times to ensure efficient operation.
- After each use, blow air through the tool housing to ensure it is free from all dust, dirt, etc. Build up of dust or dirt particles may cause the tool to overheat and shorten the life of the tool.
- If the housing of the tool requires cleaning, do not use solvents. Use of a cloth only is recommended.
- Never allow any liquid to get inside the tool, never immerse any part of the tool into liquid.

Storage

When not in use, the tool should be stored in a dry, frost free location, keep out of children's reach.

Note: Ozito Industries will not be responsible for any damage or injuries caused by repair of the tool by an unauthorised person or by mishandling.

DESCRIPTION OF SYMBOLS

V	Volts	”	Inches
∅	Diameter	°	Degrees
/min	Revolutions per minute	n_0	No load speed
mm	Millimetres	— — —	Direct Current
	Double insulated		Warning
	Wear eye, ear & breathing protection		Wear gloves
	Read Instruction Manual		Regulatory Compliance Mark (RCM)

CARING FOR THE ENVIRONMENT



Power tools that are no longer usable should not be disposed of with household waste but in an environmentally friendly way. Please recycle where facilities exist. Check with your local council authority for recycling advice.



Recycling packaging reduces the need for landfill and raw materials. Reuse of recycled material decreases pollution in the environment. Please recycle packaging where facilities exist. Check with your local council authority for recycling advice.

SPARE PARTS

Spare parts can be ordered from the Special Orders Desk at your local Bunnings Warehouse.

For further information, or any parts not listed here, visit www.ozito.com.au or contact Ozito Customer Service:

Australia 1800 069 486

New Zealand 0508 069 486

E-mail: enquiries@ozito.com.au

ELECTRICAL SAFETY

 **WARNING!** When using mains-powered tools, basic safety precautions, including the following, should always be followed to reduce risk of fire, electric shock, personal injury and material damage.

Read the whole manual carefully and make sure you know how to switch the tool off in an emergency, before operating the tool.

Save these instructions and other documents supplied with this tool for future reference.

The charger has been designed for 230V and 240V only. Always check that the power supply corresponds to the voltage on the rating plate.

Note: The supply of 230V and 240V on Ozito tools are interchangeable for Australia and New Zealand.

This tools charger is double insulated; therefore no earth wire is required.



Note: Double insulation does not take the place of normal safety precautions when operating this tool. The insulation system is for added protection against injury resulting from a possible electrical insulation failure within the tool.

If the supply cord is damaged, it must be replaced by an electrician or a power tool repairer in order to avoid a hazard.

The power supply for this products charger should be protected by a residual current device (rated at 30mA or less). A residual current device reduces the risk of electric shock.

GENERAL POWER TOOL SAFETY WARNINGS

 **WARNING!** Read all safety warnings and all instructions. Failure to follow the warnings and instructions may result in electric shock, fire and/or serious injury.

Save all warnings and instructions for future reference. The term "power tool" in the warnings refers to your mains-operated (corded) power tool or battery-operated (cordless) power tool.

1. Work area safety

- Keep work area clean and well lit.** Cluttered or dark areas invite accidents.
- Do not operate power tools in explosive atmospheres, such as in the presence of flammable liquids, gases or dust.** Power tools create sparks which may ignite the dust or fumes.
- Keep children and bystanders away while operating a power tool.** Distractions can cause you to lose control.

2. Electrical safety

- Power tool plugs must match the outlet.** Never modify the plug in any way. Do not use any adapter plugs with earthed (grounded) power tools. Unmodified plugs and matching outlets will reduce risk of electric shock.
- Avoid body contact with earthed or grounded surfaces, such as pipes, radiators, ranges and refrigerators.** There is an increased risk of electric shock if your body is earthed or grounded.
- Do not expose power tools to rain or wet conditions.** Water entering a power tool will increase the risk of electric shock.
- Do not abuse the cord.** Never use the cord for carrying, pulling or unplugging the power tool. Keep cord away from heat, oil, sharp edges or moving parts. Damaged or entangled cords increase the risk of electric shock.
- When operating a power tool outdoors, use an extension cord suitable for outdoor use.** Use of a cord suitable for outdoor use reduces the risk of electric shock.

3. Personal safety

- Stay alert, watch what you are doing and use common sense when operating a power tool.** Do not use a power tool while you are tired or under the influence of drugs, alcohol or medication. A moment of inattention while operating power tools may result in serious personal injury.
- Use personal protective equipment.** Always wear eye protection. Protective equipment such as dust mask, non-skid safety shoes, hard hat, or hearing protection used for appropriate conditions will reduce personal injuries.
- Prevent unintentional starting.** Ensure the switch is in the off-position before connecting to power source and/or battery pack, picking up or carrying the tool. Carrying power tools with your finger on the switch or energising power tools that have the switch on invites accidents.
- Remove any adjusting key or wrench before turning the power tool on.** A wrench or a key left attached to a rotating part of the power tool may result in personal injury.
- Do not overreach.** Keep proper footing and balance at all times. This enables better control of the power tool in unexpected situations.
- Dress properly.** Do not wear loose clothing or jewellery. Keep your hair, clothing and gloves away from moving parts. Loose clothes, jewellery or long hair can be caught in moving parts.
- If devices are provided for the connection of dust extraction and collection facilities, ensure these are connected and properly used.** Use of dust collection can reduce dust-related hazards.
- Do not let familiarity gained from frequent use of tools allow you to become complacent and ignore tool safety principles.** A careless action can cause severe injury within a fraction of a

second.

4. Power tool use and care

- Do not force the power tool.** Use the correct power tool for your application. The correct power tool will do the job better and safer at the rate for which it was designed.
- Do not use the power tool if the switch does not turn it on and off.** Any power tool that cannot be controlled with the switch is dangerous and must be repaired.
- Disconnect the plug from the power source and/or the battery pack from the power tool before making any adjustments, changing accessories, or storing power tools.** Such preventive safety measures reduce the risk of starting the power tool accidentally.
- Store idle power tools out of the reach of children and do not allow persons unfamiliar with the power tool or these instructions to operate the power tool.** Power tools are dangerous in the hands of untrained users.
- Maintain power tools.** Check for misalignment or binding of moving parts, breakage of parts and any other condition that may affect the power tool's operation. If damaged, have the power tool repaired before use. Many accidents are caused by poorly maintained power tools.
- Keep cutting tools sharp and clean.** Properly maintained cutting tools with sharp cutting edges are less likely to bind and are easier to control.
- Use the power tool, accessories and tool bits etc. in accordance with these instructions, taking into account the working conditions and the work to be performed.** Use of the power tool for operations different from those intended could result in a hazardous situation.
- Keep handles and grasping surfaces dry, clean and free from oil and grease.** Slippery handles and grasping surfaces do not allow for safe handling and control of the tool in unexpected situations.

5. Battery tool use and care

- Recharge only with the charger specified by the manufacturer.** A charger that is suitable for one type of battery pack may create a risk of fire when used with another battery pack.
- Use power tools only with specifically designated battery packs.** Use of any other battery packs may create a risk of injury and fire.
- When battery pack is not in use, keep it away from other metal objects, like paper clips, coins, keys, nails, screws or other small metal objects, that can make a connection from one terminal to another.** Shorting the battery terminals together may cause burns or a fire.
- Under abusive conditions, liquid may be ejected from the battery; avoid contact. If contact accidentally occurs, flush with water. If liquid contacts eyes, additionally seek medical help. Liquid ejected from the battery may cause irritation or burns.**
- Do not use a battery pack or tool that is damaged or modified.** Damaged or modified batteries may exhibit unpredictable behaviour resulting in fire, explosion or risk of injury.
- Do not expose a battery pack or tool to fire or excessive temperature.** Exposure to fire or temperature above 130°C may cause explosion.
- Follow all charging instructions and do not charge the battery pack or tool outside the temperature range specified in the instructions.** Charging improperly or at temperatures outside the specified range may damage the battery and increase the risk of fire.

6. Service

- Have your power tool serviced by a qualified repair person using only identical replacement parts.** This will ensure that the safety of the power tool is maintained.
- Never service damaged battery packs.** Service of battery packs should only be performed by the manufacturer or authorized service provider.

CIRCULAR SAW SAFETY WARNINGS

 **WARNING!** This appliance is not intended for use by persons (including children) with reduced physical, sensory or mental capabilities, or lack of experience and knowledge, unless they have been given supervision or instruction concerning use of the appliance by a person responsible for their safety.

- Keep hands away from cutting area and the blade.** Keep your second hand on auxiliary handle or motor housing. If both hands are holding the saw, they cannot be cut by the blade.
- Do not reach underneath the workpiece.** The guard cannot protect you from the blade below the workpiece.
- Adjust the cutting depth to the thickness of the workpiece.** Less than a full tooth of the blade teeth should be visible below the workpiece.
- Never hold piece being cut in your hands or across your leg. Secure the workpiece to a stable platform.** It is important to support the work properly to minimize body exposure, blade binding, or loss of control.
- Hold power tool by insulated gripping surfaces when performing an operation where the cutting tool may contact hidden wiring.** Contact with a "live" wire will also make exposed metal parts of the power tool "live" and shock the operator.
- When ripping always use a rip fence or straight edge guide.** This improves the accuracy of cut and reduces the chance of blade binding.
- Always use blades with correct size and shape (diamond versus round) of arbour holes.** Blades that do not match the mounting hardware of the saw will run eccentrically, causing loss of control.
- Never use damaged or incorrect blade washers or bolt.** The blade washers and bolt were specially designed for your saw, for optimum performance and safety of operation.
- Do not use the tool with abrasive or masonry/wet diamond wheels.**
- Only use blade diameter(s) in accordance with the markings on the tool.**

Causes and operator prevention of kickback:

Kickback is a sudden reaction to a pinched, bound or misaligned saw blade, causing an uncontrolled saw to lift up and out of the workpiece toward the operator. When the blade is pinched or bound tightly by the kerf closing down, the blade stalls and the motor reaction drives the unit rapidly back toward the operator. If the blade becomes twisted or misaligned in the cut, the teeth at the back edge of the blade can dig into the top surface of the wood causing the blade to climb out of the kerf and jump back toward the operator.

Kickback is the result of saw misuse and/or incorrect operating procedures or conditions and can be avoided by taking proper precautions as given below.

- Maintain a firm grip with both hands on the saw and position your arms to resist kickback forces. Position your body to either side of the blade, but not in line with the blade.** Kickback could cause the saw to jump backwards, but kickback forces can be controlled by the operator, if proper precautions are taken.
- When blade is binding, or when interrupting a cut for any reason, release the trigger and hold the saw motionless in the material until the blade comes to a complete stop. Never attempt to remove the saw from the work or pull the saw backward while the blade is in motion or kickback may occur.** Investigate and take corrective actions to eliminate the cause of blade binding.
- When restarting a saw in the workpiece, centre the saw blade in the kerf and check that sawteeth are not engaged into the material.** If saw blade is binding, it may walk up or kickback from the workpiece as the saw is restarted.
- Support large panels to minimise the risk of blade pinching and kickback.** Large panels tend to sag under their own weight. Supports must be placed under the panel on both sides, near the line of cut and near the edge of the panel.
- Do not use dull or damaged blades.** Blunt or improperly set blades produce narrow kerf causing excessive friction, blade binding and kickback.
- Blade depth and bevel adjusting locking levers must be tight and secure before making cut.** If blade adjustment shifts while cutting, it may cause binding and kickback.
- Use extra caution when making a "plunge cut" into existing walls or other blind areas.** The protruding blade may cut objects that can cause kickback.
- Check lower guard for proper closing before each use. Do not operate the saw if lower guard does not move freely and close instantly. Never clamp or tie the lower guard into the open position.** If saw is accidentally dropped, lower guard may be bent. Raise the lower guard with the retracting handle and make sure it moves freely and does not touch the blade or any other part, in all angles and depths of cut.
- Check the operation of the lower guard spring. If the guard and the spring are not operating properly, they must be serviced before use.** The lower guard may become sluggish due to, gummy deposits, or a build-up of debris.
- Lower guard may be retracted manually only for special cuts such as "plunge cuts" and "compound cuts." Raise lower guard by retracting handle and as soon as blade enters the material, the lower guard must be released.** For all other sawing, the lower guard should operate automatically.
- Always observe that the lower guard is covering the blade before placing saw down on bench or floor.** An unprotected, coasting blade will cause the saw to walk backwards, cutting whatever is in its path. Be aware of the time it takes for the blade to stop after switch is released.